

ERKADO

doors are our world



CATALOGUE 2023

Edition I/2023/A

EN



ALTAMURA 1 BLACK ST CPL, LUX 418, handle: BELLA SLIM, satin brass

ERKADO

doors are our world

Every house is fitted with interior doors. This is why thinking about doors from the perspective of their functional and practical features has long been insufficient. Underlining the best qualities in a perfectly furnished house, today they are an important component of interior design. For this reason, we create modern solutions, introduce attractive design and focus on the quality of workmanship to let you enjoy the choice of the Erkado doors.

We are committed to developing all business areas relevant for creating a product that meets your expectations. We achieve this goal by investing in technologically advanced production lines, staff training and systematic analysis of consumer needs. Our dynamic development would be impossible without the activity of the sales network participants. Thank you for your inspiring suggestions and friendly feedback.



The mark of responsible forestry
Look for FSC® certified products

CONTENTS

STILE DOORS	6
AMARYLIS NEW	6
PEONIA NEW	8
MISKANT.....	10
LAURENCJA.....	12
NEMEZJA.....	14
BUDLEJA.....	16
ORCHIDEA.....	18
EPIMEDIUM NEW	20
MAGNOLIA.....	22
ARALIA, NOLINA, EWODIA.....	24
POWOJNIK.....	26
JUKA BEST PRICE!	28
FORSYCJA BEST PRICE!	30
LAWENDA BEST PRICE!	32
IRYS.....	34
DAGLEZJA.....	36
FREZJA.....	38
DEBECJA.....	40
SURMIA.....	42
BERBERYS.....	44
FLOKS.....	46
KROKUS.....	48
KAMELIA.....	50
PETUNIA.....	52
AZALIA.....	54
HIACYNT.....	56
FRAGI.....	58
GRAF GLASS DOORS NEW	60
DECORATIVE LAMELLAS	62
LACQUERED DOORS	64
AMARYLIS NEW	64
PEONIA NEW	66
MISKANT.....	68
NEMEZJA.....	70
LAURENCJA.....	72
BALDUR.....	74
ANUBIS.....	76
UNO PREMIUM.....	78
TURAN.....	80
MILDA.....	82
SYLENA.....	84
INLAYS NEW	86
FLUSH DOORS	92
BALDUR.....	92
UNO PREMIUM.....	96
ALTAMURA.....	98
ANSEDONIA.....	100
LORIENT.....	102
MENTON.....	104
SORANO.....	106
INTERIOR FRONT DOORS	108
FORTECA RC2.....	108
FORTECA RC3.....	108
FIXED DOOR FRAME FOR FORTECA.....	112
STEEL DOOR FRAMES FOR FORTECA.....	113
HERSE SET.....	114
HERSE MAX SET.....	118
FIXED AND ADJUSTABLE DOOR FRAME FOR HERSE SET SERIES.....	120
STEEL DOOR FRAMES FOR FORTECA HERSE SET.....	122
UNITED STEEL DOOR FRAMES FOR HERSE SET SERIES.....	123
EXTERNAL FIRE DOORS FOR FLATS	124
LEDA EI30.....	124
LEDA EI60.....	124
WOODEN DOOR FRAME FOR LEDA SERIES.....	126
STEEL DOOR FRAMES FOR LEDA SERIES.....	126
DOUBLE LEDA EI30 & EI60.....	127
HYPERION EI30 RC2.....	128
HARDWARE – HANDLES NEW	130
TECHNICAL INFORMATION	141
CROSSHEADS AND PILASTERS NEW	147
DOOR FRAME EXTENSION PANELS NEW	148
WALL-MOUNTED SLIDING DOOR SYSTEMS	150
POCKET SLIDING DOOR SYSTEMS	156
DOUBLE DOORS	159
FOLDING DOORS	162
COVERT CONCEALED DOOR SYSTEM	163
SIDELIGHTS FOR DOORS	166
DOOR FRAMES	168
TUNNEL TYPE ADJUSTABLE DOOR FRAME.....	171
STEEL DOOR FRAME.....	172
NON-REBATED STEEL DOOR FRAME NEW	173
ADJUSTABLE CASING FRAME FOR STEEL DOOR FRAMES.....	174
REVERSE DOOR FRAME.....	175
ADJUSTABLE DOOR FRAME FOR NON-REBATED DOORS.....	176
FIXED FRAME FOR REBATED DOORS.....	177
ADJUSTABLE DOOR FRAME FOR REBATED DOORS.....	178



DECORS

COLOURS AVAILABLE FOR INTERIOR DOORS

GREKO



GOLDEN OAK GREKO

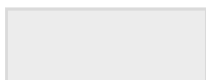

WHITE GREKO
(similar to: RAL 9010,
NCS S 0502-Y50R)



ELM GREKO



GREY OAK GREKO



SANREMO GREKO



LIGHT ACACIA GREKO



WALNUT GREKO



OAK GREKO



MEDIUM OAK GREKO



SONOMA GREKO



SNOW-WHITE GREKO
(similar to: RAL 9016,
NCS S 0300-N)

PREMIUM



WALNUT PREMIUM



GREY MAPLE PREMIUM



OAK PREMIUM

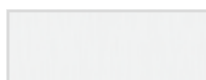

WHITE BARK PREMIUM

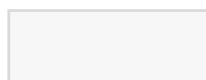

WHITE PREMIUM
(similar to: RAL 9003,
NCS S 0500-N)



CONCRETE PREMIUM



GRAPHITE ASH PREMIUM



NATUR OAK PREMIUM



NATUR OAK PREMIUM
HORIZONTAL ¹⁾

CPL



OAK ST CPL



GREY OAK ST CPL



VENGE ST CPL



GREY PINE ST CPL

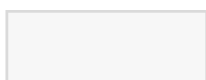

WHITE ST CPL ¹⁾
(similar to: RAL 9003,
NCS S 0500-N)



BLACK ST CPL ¹⁾
(similar to: RAL 9011,
NCS S 9000-N)

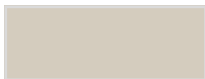

CAPPUCCINO ST CPL ¹⁾
(similar to: RAL D2 080 80 05
NCS S3005-Y50R)

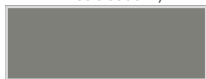

LIGHT GREY ST CPL ¹⁾
(similar to: RAL 7037,
NCS S 5500-N)

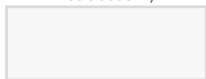

WHITE CPL 0.2 & 0.7
(similar to: RAL 9003,
NCS S 0300-N)



ROYAL BLUE ST CPL ¹⁾
(similar to: RAL 5011,
NCS 8010-R90B)



DARK GREEN ST CPL ¹⁾
(similar to: RAL 6007,
NCS S 8010-G30Y)



ASH GREY ST CPL ¹⁾
(similar to: RAL 7047,
NCS S 2500-N)



WALNUT CLASSIC CPL 0.2 & 0.7



OAK RETRO CPL 0.2 & 0.7



OAK CLASSIC CPL 0.2 & 0.7

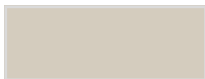

ASH GREY CPL 0.2 & 0.7
(similar to: RAL 7047,
NCS S 2500-N)

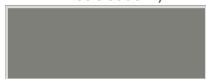

ANTHRACITE CPL 0.2 & 0.7
(similar to: RAL D2 000 35 00,
NCS S 7000-N)

NEW

UV-PAINTED

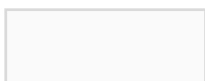

WHITE TITANIUM UV
(similar to: RAL 9003,
NCS S 0500-N)

Read more on facings on p. 142

* special AntiFinger coating to reduce dirt and fingerprints

¹⁾ Only used on selected flush doors. comes complete with the NATUR OAK PREMIUM door frame



STILE DOORS

REBATED AND NON-REBATED



Solid 35 mm or 22 mm thick rail



Aesthetic frameless tongue-and-groove glazing without bars



Attractive GREKO laminate, resistant CPL facing or PREMIUM facing which is both good-looking and durable



RUMBA handle with antibacterial coating containing active silver ions (optional)



Solid dowel joint



Free factory through hole drilling for handles (split handles) if ordered together with the leaf



Three adjustable 2-pin hinges set in a robust 40 mm thick stile (optional hinge covers)



Modern tempered and frosted or optionally: clear and novel VSG glass: mat or black



Drop down seal (optional)



MDF stiles



Concealed magnetic stop (optionally)

¹⁾ Available at extra charge for rebated and non-rebated models, and the non-rebated models for sliding systems in PL and CZ standard for WHITE PREMIUM, NATUR OAK PREMIUM, GRAPHITE ASH PREMIUM, GREY MAPLE PREMIUM, OAK ST CPL



AMARYLIS

REBATED AND NON-REBATED INTERIOR STILE DOORS



AMARYLIS 1, clear glass, BLACK ST CPL facing layer, handle: BELLA SLIM, glossy brass

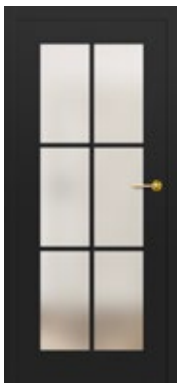

AMARYLIS 1

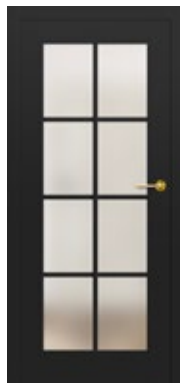

AMARYLIS 2



AMARYLIS 3



AMARYLIS 4



AMARYLIS 5



AMARYLIS 6



AMARYLIS 7



AMARYLIS 8



AMARYLIS 9



NEW

stick-on glazing bar on both sides, 25 mm wide

AMARYLLIS 3, NATUR OAK PREMIUM facing layer, handle: BELLA SLIM, round, black matt



CONSTRUCTION

- rebated or non-rebated door leaf made in the STILE panelled technology
- MDF stiles and rails covered with the GREKO, PREMIUM, ST CPL facings or ST CPL laminate with the AntiFinger coating
- glulam laminated stiles covered with HDF and MDF boards⁴⁾
- stick-on glazing bar on both sides, 25 mm wide, heights of 12 mm (vertical) and 8 mm (horizontal)
- optional door frame extension panels and a crosshead with pilasters are available for an additional charge, p. 147-149
- the door can be trimmed by a customer, go to p. 145 for details

HARDWARE

- rebated door leaves: three silver 2-pin hinges adjusted horizontally
- three concealed hinges in a non-rebated leaf, silver (optionally black - subject to an additional charge); hinges supplied with and included in the price of the door frame
- lever tumbler lock in a rebated door leaf and a key-locked magnetic lock (lever tumbler lock as an option) in a non-rebated door leaf, thumb turn cylinder, economy, with a silver blockage; optionally, for an additional charge, a black or gold magnetic lock

GLAZING

- tempered clear or frosted glass with a thickness of 4 mm
- possibility to change the glazing side to REVERSE (standard glazing for OBERSE)

AVAILABLE SOLUTIONS (p. 150-161)

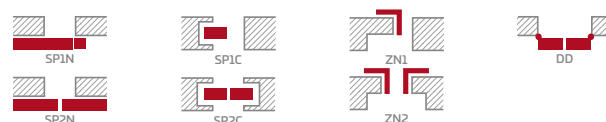

AVAILABLE DOOR LEAF WIDTHS

- 60 70 80N⁵⁾ 80 90 100

EXTRA CHARGES

factory pre-drilled through holes for handles (split handles) ordered together with the door leaf

VSG 221 laminated safety glass, plain on both sides, frosted or black

door undercut (p. 145) or air gap undercut

plastic woodgrain sleeves (4 pcs)

round and square metal sleeves (4 pcs); brushed nickel or patina finish in white and black

ventilation grille (only for door leaf widths of 80, 90, 100)

"100" rebated and non-rebated door leaf

metal hinge casings in the rebated door leaf (brushed nickel, patina, polished chrome, polished brass, white and black)

drop down seal²⁾

can be replaced with a black or golden magnetic lock for non-rebated door leaves

magnetic stop (buffer)²⁾
(available in six colours p. 145)

glulam stiles⁴⁾

GREKO

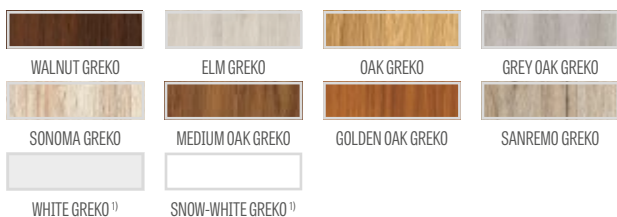

PREMIUM

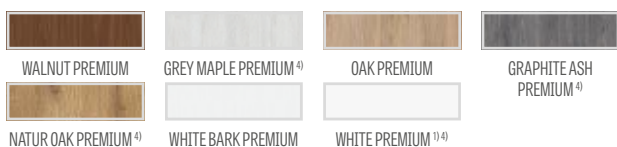

CPL



glulam stiles⁴⁾

¹⁾ plain white facing imitating a painted surface

²⁾ a stop will not allow a drop down seal and an door undercut to be used, and vice versa

³⁾ special AntiFinger coating to reduce dirt and fingerprints

⁴⁾ glulam stiles covered with HDF and MDF boards available for WHITE PREMIUM, NATUR OAK PREMIUM, GRAPHITE ASH PREMIUM, GREY MAPLE PREMIUM, OAK ST CPL at extra charge

⁵⁾ only for non-rebated door leaves



PEONIA

REBATED AND NON-REBATED INTERIOR STILE DOORS



PEONIA 3, frosted glass, DARK GREEN ST CPL facing layer, BELLA SLIM handle, glossy brass, decorative crosshead⁶⁾



PEONIA 1



PEONIA 2



PEONIA 3



PEONIA 4



PEONIA 5



PEONIA 6



NEW

stick-on glazing bar on both sides, 25 mm wide

PEONIA 3, ASH GREY ST CPL facing layer with CUBE PREMIUM handle in black matt, decorative crosshead⁶⁾



CONSTRUCTION

- rebated or non-rebated door leaf made in the STILE panelled technology
- MDF stiles and rails covered with the GREKO, PREMIUM, ST CPL facings or ST CPL laminate with the AntiFinger coating
- glulam laminated stiles covered with HDF and MDF boards⁴⁾
- bevelled 16 mm thick HDF panels with a selection of GREKO, CPL or PREMIUM facing
- stick-on glazing bar on both sides, 25 mm wide, heights of 12 mm (vertical) and 8 mm (horizontal)
- optional door frame extension panels and a crosshead with pilasters are available for an additional charge, p. 147-149
- the door can be trimmed by a customer; go to p. 145 for details

HARDWARE

- rebated door leaves: three silver 2-pin hinges adjusted horizontally
- three concealed hinges in a non-rebated leaf, silver (optionally black - subject to an additional charge); hinges supplied with and included in the price of the door frame
- lever tumbler lock in a rebated door leaf and a key-locked magnetic lock (lever tumbler lock as an option) in a non-rebated door leaf, thumb turn cylinder, economy, with a silver blockade; optionally, for an additional charge, a black or gold magnetic lock

GLAZING

- tempered 4 mm glass, frosted or clear as a standard and, for an additional charge, laminated VSG 221 safety glass frosted or black plain on both sides
- possibility to change the glazing side to REVERSE (standard glazing for OBVERSE)

AVAILABLE SOLUTIONS (p. 150-161)

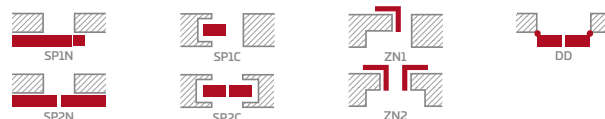

AVAILABLE DOOR LEAF WIDTHS

- 60
- 70
- 80N⁵⁾
- 80
- 90
- 100

EXTRA CHARGES

- factory pre-drilled through holes for handles (split handles) ordered together with the door leaf
- door undercut (p. 145) or air gap undercut
- plastic woodgrain sleeves (4 pcs)
- round and square metal sleeves (4 pcs); brushed nickel or patina finish in white and black
- ventilation grille (only for door leaf widths of 80, 90, 100)
- "100" rebated and non-rebated door leaf
- VSG 221 laminated safety glass, plain on both sides, frosted or black
- metal hinge casings in the rebated door leaf (brushed nickel, patina, polished chrome, polished brass, white and black)
- drop down seal²⁾
- can be replaced with a black or golden magnetic lock for non-rebated door leaves
- magnetic stop (buffer)²⁾ (available in six colours p. 145)
- glulam stiles⁴⁾

GREKO

WALNUT GREKO	ELM GREKO	OAK GREKO	GREY OAK GREKO
SONOMA GREKO	MEDIUM OAK GREKO	GOLDEN OAK GREKO	SANREMO GREKO
WHITE GREKO ¹⁾	SNOW-WHITE GREKO ¹⁾		

PREMIUM

WALNUT PREMIUM	GREY MAPLE PREMIUM ⁴⁾	OAK PREMIUM	GRAPHITE ASH PREMIUM ⁴⁾
NATUR OAK PREMIUM ⁴⁾	WHITE BARK PREMIUM	WHITE PREMIUM ^{1) 4)}	

CPL

WHITE ST CPL ^{1) 3)}	OAK ST CPL ⁴⁾	GREY OAK ST CPL	VENGE ST CPL
GREY PINE ST CPL	CAPPUCCINO ST CPL ³⁾	LIGHT GREY ST CPL ³⁾	BLACK ST CPL ³⁾
DARK GREEN ST CPL ³⁾	ROYAL BLUE ST CPL ³⁾	ASH GREY ST CPL 3	NEW



¹⁾ plain white facing imitating a painted surface
²⁾ a stop will not allow a drop down seal and an door undercut to be used, and vice versa
³⁾ special AntiFinger coating to reduce dirt and fingerprints
⁴⁾ glulam stiles covered with HDF and MDF boards available for WHITE PREMIUM, NATUR OAK PREMIUM, GRAPHITE ASH PREMIUM, GREY MAPLE PREMIUM, OAK ST CPL at extra charge
⁵⁾ only for non-rebated door leaves
⁶⁾ decorative crosshead with pilasters for an additional charge, p. 147



MISKANT

REBATED AND NON-REBATED INTERIOR STILE DOORS



MISKANT 2, BLACK ST CPL facing layer, handle: BELLA SLIM, black matt

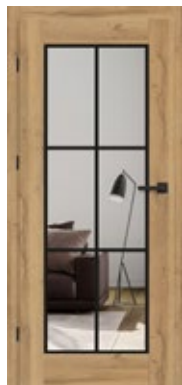

MISKANT 1

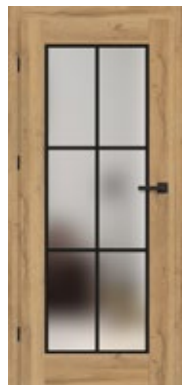

MISKANT 2

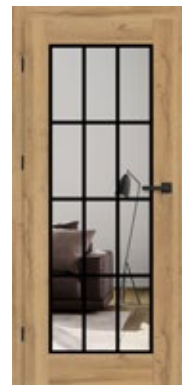

MISKANT 3



NEW

Black lines with a width of 18 mm, screen painted



MISKANT 4

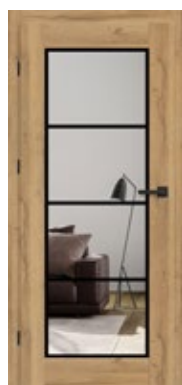

MISKANT 5



MISKANT 6

MISKANT 3, NATUR OAK PREMIUM facing layer, Frame in BLACK ST CPL, handle: CUBE, black matt

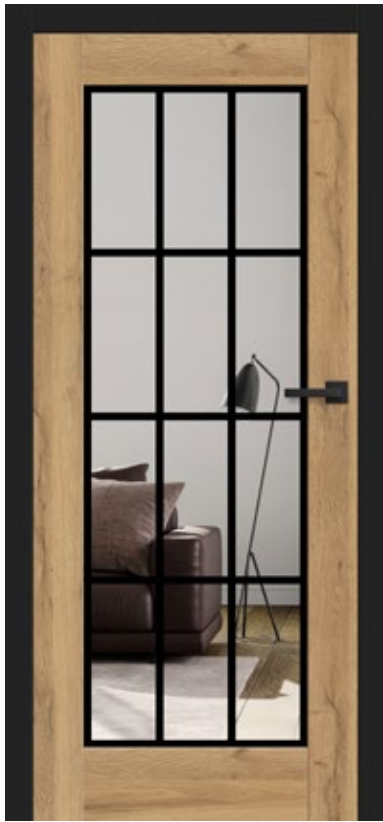

GREKO

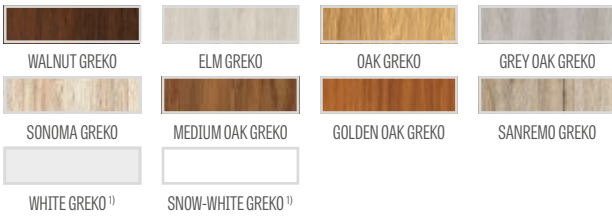

PREMIUM

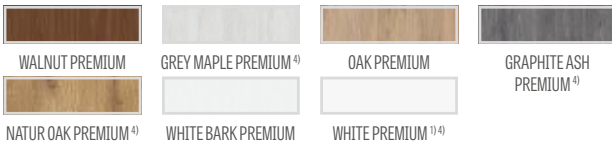

CPL



glulam stiles⁴⁾

STANDARD "OBVERSE" GLAZING



"REVERSE" GLAZING MADE TO ORDER



CONSTRUCTION

- rebated or non-rebated door leaf made in the STILE panelled technology
- MDF stiles and rails covered with the GREKO, PREMIUM, ST CPL facings or ST CPL laminate with the AntiFinger coating
- glulam laminated stiles covered with HDF and MDF boards⁴⁾
- optional door frame extension panels and a crosshead with pilasters are available for an additional charge, p. 147-149
- the door can be trimmed by a customer, go to p. 145 for details

HARDWARE

- rebated door leaves: three silver 2-pin hinges adjusted horizontally
- three concealed hinges in a non-rebated leaf, silver (optionally black - subject to an additional charge); hinges supplied with and included in the price of the door frame
- lever tumbler lock in a rebated door leaf and a key-locked magnetic lock (lever tumbler lock as an option) in a non-rebated door leaf, thumb turn cylinder, economy, with a silver blockade; optionally, for an additional charge, a black or gold magnetic lock

GLAZING

- tempered frosted glass (MISKANT 2, 4, 6) or clear glass (MISKANT 1, 3, 5), 4 mm thick or, for an additional charge, VSG laminated glass with internal decorative pattern
- possibility to change the glazing side to REVERSE (standard glazing for OBVERSE)
- black lines, 18 mm wide (thickness), screen printed on one side of the glazing

AVAILABLE SOLUTIONS (p. 150-161)

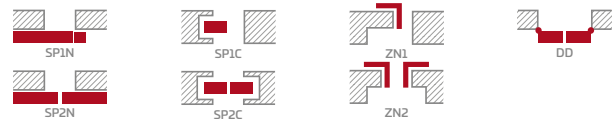

AVAILABLE DOOR LEAF WIDTHS



EXTRA CHARGES

factory pre-drilled through holes for handles (split handles) ordered together with the door leaf

VSG laminated glass with internal decorative pattern in black or white

door undercut (p. 145) or air gap undercut

plastic woodgrain sleeves (4 pcs)

round and square metal sleeves (4 pcs); brushed nickel or patina finish in white and black

ventilation grille (only for door leaf widths of 80, 90, 100)

"100" rebated and non-rebated door leaf

metal hinge casings in the rebated door leaf (brushed nickel, patina, polished chrome, polished brass, white and black)

drop down seal²⁾

can be replaced with a black or golden magnetic lock for non-rebated door leaves

magnetic stop (buffer)²⁾
(available in six colours p. 145)

glulam stiles⁴⁾

¹⁾ plain white facing imitating a painted surface

²⁾ a stop will not allow a drop down seal and an door undercut to be used, and vice versa

³⁾ special AntiFinger coating to reduce dirt and fingerprints

⁴⁾ glulam stiles covered with HDF and MDF boards available for WHITE PREMIUM, NATUR OAK PREMIUM, GRAPHITE ASH PREMIUM, GREY MAPLE PREMIUM, OAK ST CPL at extra charge

⁵⁾ only for non-rebated door leaves



LAURENCJA

REBATED AND NON-REBATED INTERIOR STILE DOORS



LAURENCJA 1, LIGHT GREY ST CPL facing layer, VSG black glass, handle: QUANTA FIT, black matt



LAURENCJA 1



LAURENCJA 2



LAURENCJA 3



LAURENCJA 4



LAURENCJA 5



LAURENCJA 6

LAURENCJA 1 with PREMIUM WHITE facing layer, CUBE PREMIUM handle, black matt, and black VSG 221 laminated glass



CONSTRUCTION

- rebated or non-rebated door leaf made in the STILE panelled technology
- MDF stiles and rails covered with the PREMIUM, ST CPL facings or ST CPL laminate with the AntiFinger coating
- glulam laminated stiles covered with HDF and MDF boards⁴⁾
- 4mm thick HDF panels with CPL or PREMIUM facing
- very wide crossbar - 35 mm
- optional door frame extension panels and a crosshead with pilasters are available for an additional charge, p. 147-149
- the door can be trimmed by a customer, go to p. 145 for details

HARDWARE

- rebated door leaves: three silver 2-pin hinges adjusted horizontally
- three concealed hinges in a non-rebated leaf, silver (optionally black - subject to an additional charge); hinges supplied with and included in the price of the door frame
- lever tumbler lock in a rebated door leaf and a key-locked magnetic lock (lever tumbler lock as an option) in a non-rebated door leaf, thumb turn cylinder, economy, with a silver blockade; optionally, for an additional charge, a black or gold magnetic lock

GLAZING

- tempered 4 mm glass, frosted or clear as a standard and, for an additional charge, laminated VSG 221 safety glass frosted or black plain on both sides
- possibility to change the glazing side to REVERSE (standard glazing for OBERSE)

AVAILABLE SOLUTIONS (p. 150-161)

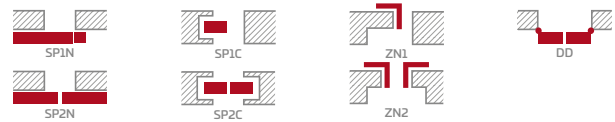

AVAILABLE DOOR LEAF WIDTHS

60 70 80N⁵⁾ 80 90 100

EXTRA CHARGES

factory pre-drilled through holes for handles (split handles) ordered together with the door leaf

door undercut (p. 145) or air gap undercut

plastic woodgrain sleeves (4 pcs)

round and square metal sleeves (4 pcs); brushed nickel or patina finish in white and black

ventilation grille (only for door leaf widths of 80, 90, 100)

"100" rebated and non-rebated door leaf

VSG 221 laminated safety glass, plain on both sides, frosted or black

metal hinge casings in rebated door leaf (colour: brushed nickel, patina, glossy chrome, glossy brass, white and black)

drop down seal²⁾

can be replaced with a black or golden magnetic lock for non-rebated door leaves

magnetic stop (buffer)²⁾ (available in six colours p. 145)

glulam stiles⁴⁾

PREMIUM

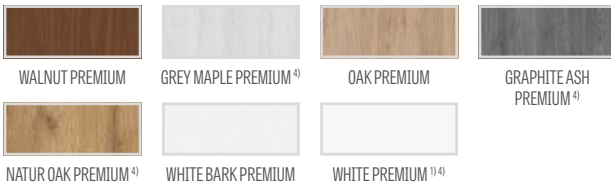

CPL

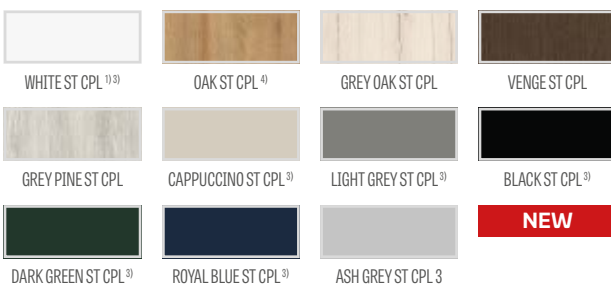

glulam stiles⁴⁾

¹⁾ plain white facing imitating a painted surface

²⁾ a stop will not allow a drop down seal and an door undercut to be used, and vice versa

³⁾ special AntiFinger coating to reduce dirt and fingerprints

⁴⁾ glulam stiles covered with HDF and MDF boards available for WHITE PREMIUM, NATUR OAK PREMIUM, GRAPHITE ASH PREMIUM, GREY MAPLE PREMIUM, OAK ST CPL at extra charge

⁵⁾ only for non-rebated door leaves



NEMEZJA

REBATED AND NON-REBATED INTERIOR STILE DOORS



NEMEZJA 6, ST CPL facing layer, handle: BELLA SLIM, glossy brass



NEMEZJA 1



NEMEZJA 4



NEMEZJA 6



NEMEZJA 7



NEMEZJA 8



NEMEZJA 9



NEMEZJA 10



NEMEZJA 11



NEMEZJA 12



NEMEZJA 13

NEMEZJA 14 in ST CPL facing layer with BELLA SLIM handle, glossy brass

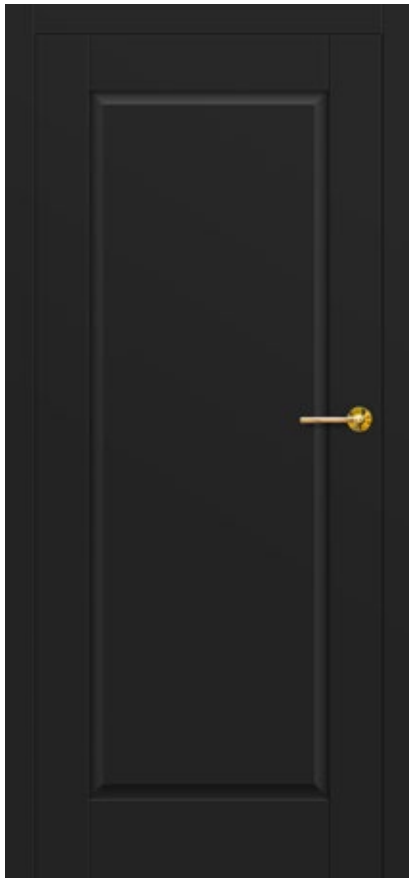

CONSTRUCTION

- rebated or non-rebated door leaf made in the STILE panelled technology
- MDF stiles and rails covered with the GREKO, PREMIUM, ST CPL facings or ST CPL laminate with the AntiFinger coating
- glulam laminated stiles covered with HDF and MDF boards⁴⁾
- bevelled 16 mm thick HDF panels with a selection of GREKO, CPL or PREMIUM facing
- optional door frame extension panels and a crosshead with pilasters are available for an additional charge, p. 147-149
- the door can be trimmed by a customer, go to p. 145 for details

HARDWARE

- rebated door leaves: three silver 2-pin hinges adjusted horizontally
- three concealed hinges in a non-rebated leaf, silver (optionally black - subject to an additional charge); hinges supplied with and included in the price of the door frame
- lever tumbler lock in a rebated door leaf and a key-locked magnetic lock (lever tumbler lock as an option) in a non-rebated door leaf, thumb turn cylinder, economy, with a silver blockage; optionally, for an additional charge, a black or gold magnetic lock

GLAZING

- tempered 4 mm glass, frosted or clear as a standard and, for an additional charge, laminated VSG 221 safety glass frosted or black plain on both sides
- possibility to change the glazing side to REVERSE (standard glazing for OBVERSE)

AVAILABLE SOLUTIONS (p. 150-161)

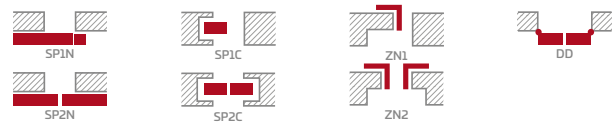

AVAILABLE DOOR LEAF WIDTHS

60 70 80N⁵⁾ 80 90 100

EXTRA CHARGES

factory pre-drilled through holes for handles (split handles) ordered together with the door leaf

door undercut (p. 145) or air gap undercut

plastic woodgrain sleeves (4 pcs)

round and square metal sleeves (4 pcs); brushed nickel or patina finish in white and black

ventilation grille (only for door leaf widths of 80, 90, 100)

"100" rebated and non-rebated door leaf

VSG 221 laminated safety glass, plain on both sides, frosted or black

metal hinge casings in the rebated door leaf (brushed nickel, patina, polished chrome, polished brass, white and black)

drop down seal²⁾

can be replaced with a black or golden magnetic lock for non-rebated door leaves

magnetic stop (buffer)²⁾
(available in six colours p. 145)

glulam stiles⁴⁾

GREKO

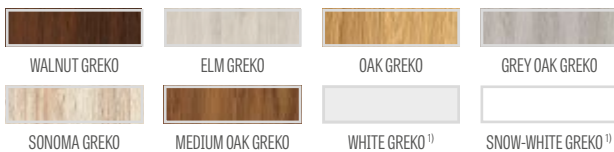

PREMIUM

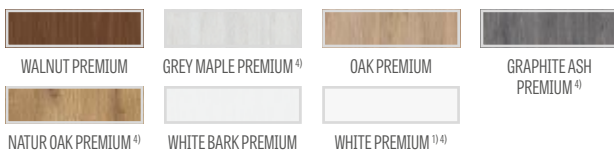

CPL



glulam stiles⁴⁾

¹⁾ plain white facing imitating a painted surface

²⁾ a stop will not allow a drop down seal and an door undercut to be used, and vice versa

³⁾ special AntiFinger coating to reduce dirt and fingerprints

⁴⁾ glulam stiles covered with HDF and MDF boards available for WHITE PREMIUM, NATUR OAK PREMIUM, GRAPHITE ASH PREMIUM, GREY MAPLE PREMIUM, OAK ST CPL at extra charge

⁵⁾ only for non-rebated door leaves



BUDLEJA

REBATED AND NON-REBATED INTERIOR STILE DOORS



BUDLEJA 6, OAK ST CPL facing layer; handle: CUBE PREMIUM, black matt



BUDLEJA 1



BUDLEJA 2



BUDLEJA 3



BUDLEJA 4



BUDLEJA 5



BUDLEJA 6



BUDLEJA 7



BUDLEJA 8

BUDLEJA 1 in OAK ST CPL facing with TOPAZ stainless steel handle



CONSTRUCTION

- rebated or non-rebated door leaf made in the STILE panelled technology
- MDF stiles and rails covered with the PREMIUM, ST CPL facings or ST CPL laminate with the AntiFinger coating
- glulam laminated stiles covered with HDF and MDF boards⁴⁾
- very wide crossbar - 35 mm
- optional door frame extension panels and a crosshead with pilasters are available for an additional charge, p. 147-149
- the door can be trimmed by a customer, go to p. 145 for details

HARDWARE

- rebated door leaves: three silver 2-pin hinges adjusted horizontally
- three concealed hinges in a non-rebated leaf, silver (optionally black - subject to an additional charge); hinges supplied with and included in the price of the door frame
- lever tumbler lock in a rebated door leaf and a key-locked magnetic lock (lever tumbler lock as an option) in a non-rebated door leaf, thumb turn cylinder, economy, with a silver blockade; optionally, for an additional charge, a black or gold magnetic lock

GLAZING

- tempered 4 mm glass, frosted or clear as a standard and, for an additional charge, laminated VSG 221 safety glass frosted or black plain on both sides
- possibility to change the glazing side to REVERSE (standard glazing for OBVERSE)

AVAILABLE SOLUTIONS (p. 150-161)

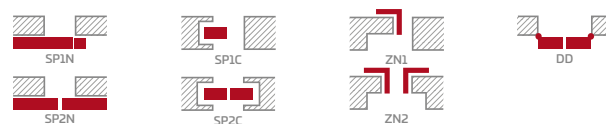

AVAILABLE DOOR LEAF WIDTHS

60 70 80N⁵⁾ 80 90 100

PREMIUM

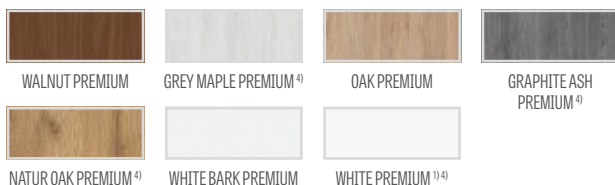

CPL



glulam stiles⁴⁾

EXTRA CHARGES

factory pre-drilled through holes for handles (split handles) ordered together with the door leaf

door undercut (p. 145) or air gap undercut

plastic woodgrain sleeves (4 pcs)

round and square metal sleeves (4 pcs); brushed nickel or patina finish in white and black

ventilation grille (only for door leaf widths of 80, 90, 100)

"100" rebated and non-rebated door leaf

VSG 221 laminated safety glass, plain on both sides, frosted or black

metal hinge casings in rebated door leaf
(colour: brushed nickel, patina, glossy chrome, glossy brass, white and black)

drop down seal²⁾

can be replaced with a black or golden magnetic lock for non-rebated door leaves

magnetic stop (buffer)²⁾
(available in six colours p. 145)

glulam stiles⁴⁾

¹⁾ plain white facing imitating a painted surface

²⁾ a stop will not allow a drop down seal and an door undercut to be used, and vice versa

³⁾ special AntiFinger coating to reduce dirt and fingerprints

⁴⁾ glulam stiles covered with HDF and MDF boards available for WHITE PREMIUM, NATUR OAK PREMIUM, GRAPHITE ASH PREMIUM, GREY MAPLE PREMIUM, OAK ST CPL at extra charge

⁵⁾ only for non-rebated door leaves



ORCHIDEA

REBATED AND NON-REBATED INTERIOR STILE DOORS



ORCHIDEA 4 with BLACK ST CPL facing and black matt CUBE handle



ORCHIDEA 1



ORCHIDEA 2



ORCHIDEA 3



ORCHIDEA 4



ORCHIDEA 5



ORCHIDEA 6

ORCHIDEA 4 in WHITE ST CPL facing layer with BELLA SLIM handle, glossy brass, golden decorative pattern



CONSTRUCTION

- rebated or non-rebated door leaf made in the STILE panelled technology
- MDF stiles and rails covered with the PREMIUM, ST CPL facings or ST CPL laminate with the AntiFinger coating
- glulam laminated stiles covered with HDF and MDF boards⁴⁾
- optional door frame extension panels and a crosshead with pilasters are available for an additional charge, p. 147-149
- the door can be trimmed by a customer, go to p. 145 for details

HARDWARE

- rebated door leaves: three silver 2-pin hinges adjusted horizontally
- three concealed hinges in a non-rebated leaf, silver (optionally black - subject to an additional charge); hinges supplied with and included in the price of the door frame
- lever tumbler lock in a rebated door leaf and a key-locked magnetic lock (lever tumbler lock as an option) in a non-rebated door leaf, thumb turn cylinder, economy, with a silver blockade; optionally, for an additional charge, a black or gold magnetic lock

GLAZING

- VSG 221 mat or non-tinted laminated glass with black or gold decorative pattern as a standard

AVAILABLE SOLUTIONS (p. 150-161)

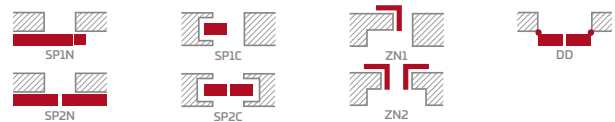

AVAILABLE DOOR LEAF WIDTHS

60 70 80N⁵⁾ 80 90 100

EXTRA CHARGES

factory pre-drilled through holes for handles (split handles) ordered together with the door leaf

door undercut (p. 145) or air gap undercut

plastic woodgrain sleeves (4 pcs)

round and square metal sleeves (4 pcs); brushed nickel or patina finish in white and black

ventilation grille (only for door leaf widths of 80, 90, 100)

"100" rebated and non-rebated door leaf

metal hinge casings in rebated door leaf (colour: brushed nickel, patina, glossy chrome, glossy brass, white and black)

drop down seal²⁾

can be replaced with a black or golden magnetic lock for non-rebated door leaves

magnetic stop (buffer)²⁾ (available in six colours p. 145)

glulam stiles⁴⁾

PREMIUM

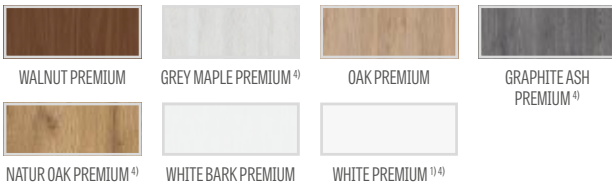

CPL

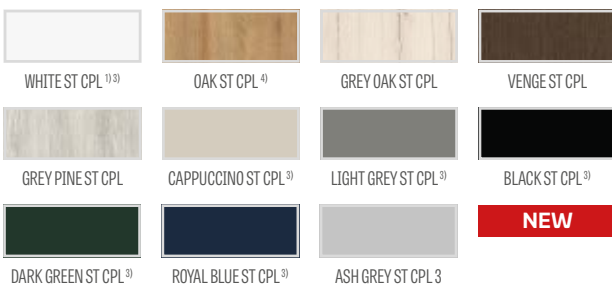

glulam stiles⁴⁾

¹⁾ plain white facing imitating a painted surface

²⁾ a stop will not allow a drop down seal and an door undercut to be used, and vice versa

³⁾ special AntiFinger coating to reduce dirt and fingerprints

⁴⁾ glulam stiles covered with HDF and MDF boards available for WHITE PREMIUM, NATUR OAK PREMIUM, GRAPHITE ASH PREMIUM, GREY MAPLE PREMIUM, OAK ST CPL at extra charge

⁵⁾ only for non-rebated door leaves



EPIMEDIUM

REBATED AND NON-REBATED INTERIOR STILE DOORS

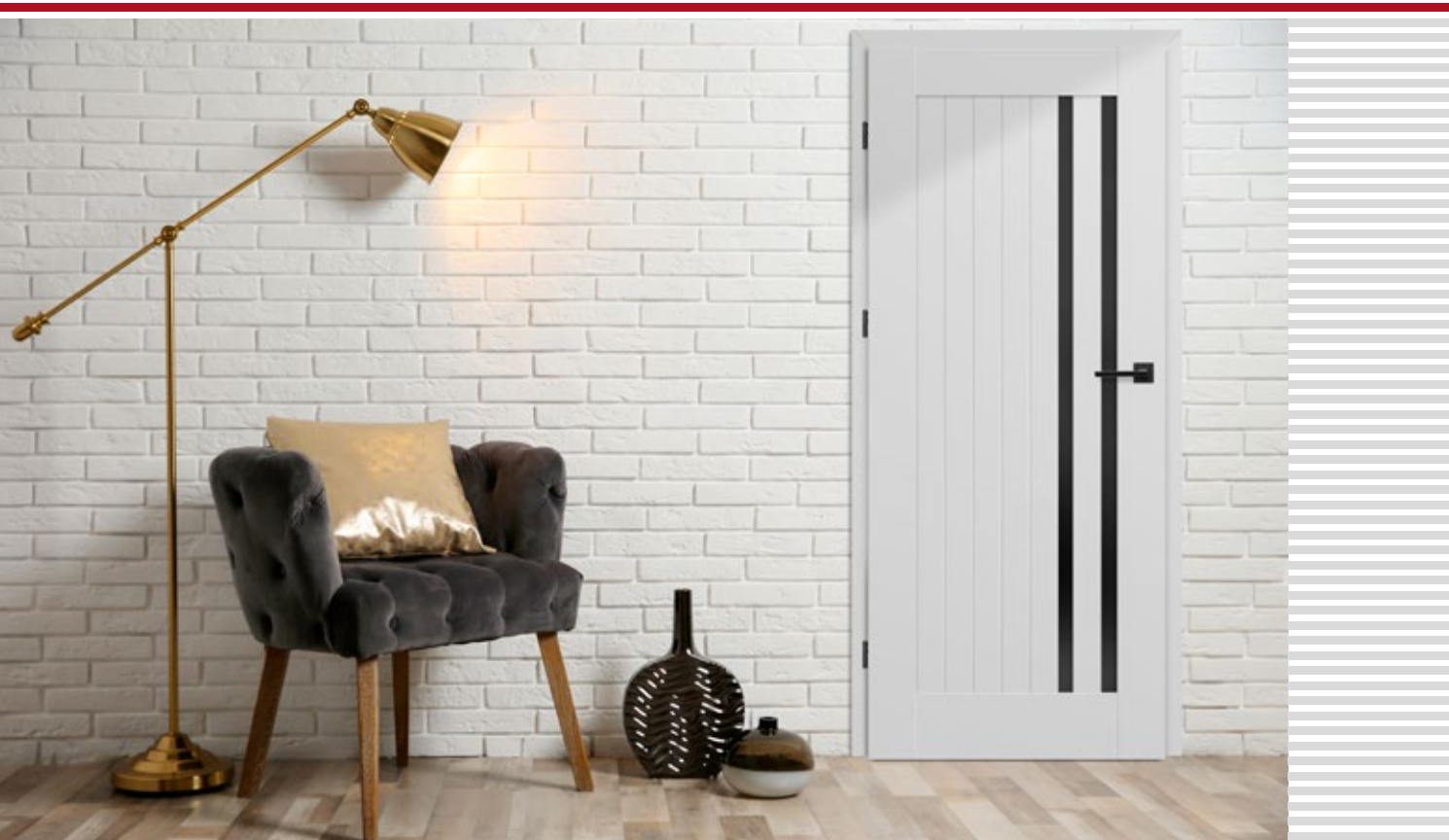

EPIMEDIUM 6, ASH GREY ST CPL facing layer, VSG black glass, handle: QUANTA FIT, black matt

WIDTH 80



EPIMEDIUM 1^{*)}



EPIMEDIUM 2^{*)}



EPIMEDIUM 3^{*)}



EPIMEDIUM 4^{*)}



EPIMEDIUM 6^{*)}

WIDTH 70

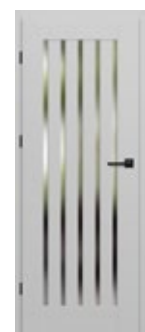

EPIMEDIUM 1^{*)}



EPIMEDIUM 2^{*)}

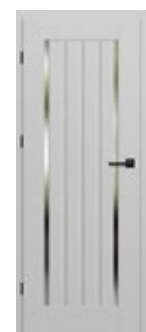

EPIMEDIUM 3^{*)}



EPIMEDIUM 4^{*)}



EPIMEDIUM 6^{*)}

^{*)} The pictures show only the EPIMEDIUM doors with 80 and 70 cm wide leaves.

The glazing to vertical bars ratio in the other width options differs considerably, which can be the key factor regarding the customer's product choice.

For the other width options go to www.erkado.pl

EPTMEDIUM 6 in grey ST CPL facing layer with QUANTA FTI handle, black matt, VSG glass, black



GREKO

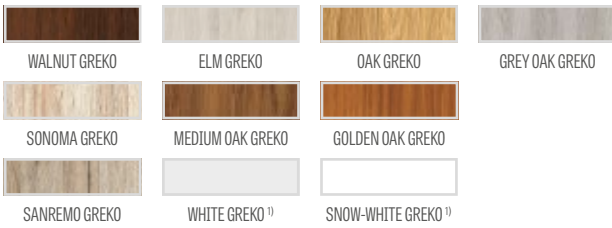

PREMIUM

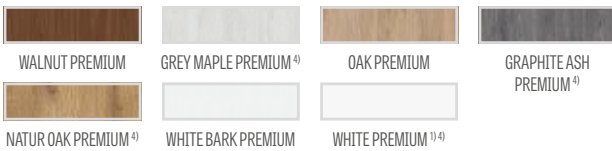

CPL

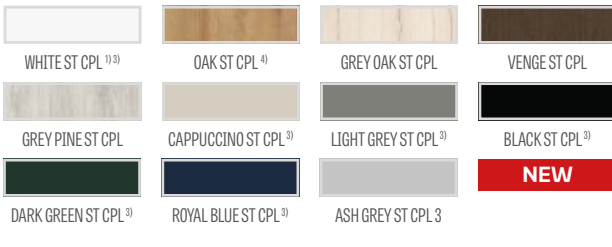

CONSTRUCTION

- rebated or non-rebated door leaf made in the STILE panelled technology
- MDF stiles and rails covered with the GREKO, PREMIUM, ST CPL facings or ST CPL laminate with the AntiFinger coating
- glulam laminated stiles covered with HDF and MDF boards 4)
- 4mm thick HDF panels with GREKO, CPL or PREMIUM finish
- narrow, long crossbar of 22 mm
- optional door frame extension panels and a crosshead with pilasters are available for an additional charge, p. 147-149
- the door can be trimmed by a customer; go to p. 145 for details

HARDWARE

- rebated door leaves: three silver 2-pin hinges adjusted horizontally
- three concealed hinges in a non-rebated leaf, silver (optionally black - subject to an additional charge); hinges supplied with and included in the price of the door frame
- lever tumbler lock in a rebated door leaf and a key-locked magnetic lock (lever tumbler lock as an option) in a non-rebated door leaf, thumb turn cylinder, economy, with a silver blockade; optionally, for an additional charge, a black or gold magnetic lock

GLAZING

- tempered 4 mm glass, frosted or clear as a standard and, for an additional charge, laminated VSG 221 safety glass frosted or black plain on both sides
 - possibility to change the glazing side to REVERSE (standard glazing for OBVERSE)
 - depending on the leaf width, the glazing widths differ.
- Check at www.erkado.pl

AVAILABLE SOLUTIONS (p. 150-161)

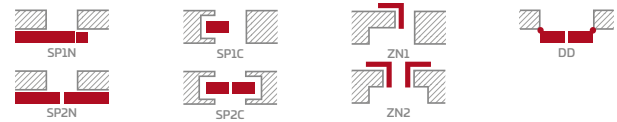

AVAILABLE DOOR LEAF WIDTHS



EXTRA CHARGES

- factory pre-drilled through holes for handles (split handles) ordered together with the door leaf
- door undercut (p. 145) or air gap undercut
- plastic woodgrain sleeves (4 pcs)
- round and square metal sleeves (4 pcs); brushed nickel or patina finish in white and black
- ventilation grille (only for door leaf widths of 80, 90, 100)
- "100" rebated and non-rebated door leaf
- VSG 221 laminated safety glass, plain on both sides, frosted or black
- metal hinge casings in the rebated door leaf (brushed nickel, patina, polished chrome, polished brass, white and black)
- drop down seal 2)
- can be replaced with a black or golden magnetic lock for non-rebated door leaves
- magnetic stop (buffer) 2)
- (available in six colours p. 145)
- glulam stiles 4)

1) plain white facing imitating a painted surface

2) a stop will not allow a drop down seal and an door undercut to be used, and vice versa

3) special AntiFinger coating to reduce dirt and fingerprints

4) glulam stiles covered with HDF and MDF boards available for WHITE PREMIUM, NATUR OAK PREMIUM, GRAPHITE ASH PREMIUM, GREY MAPLE PREMIUM, OAK ST CPL at extra charge

5) only for non-rebated door leaves



MAGNOLIA

REBATED AND NON-REBATED INTERIOR STILE DOORS



MAGNOLIA 1, OAK PREMIUM facing layer, TOPAZ stainless steel handle



MAGNOLIA 1



MAGNOLIA 2



MAGNOLIA 3



MAGNOLIA 4



MAGNOLIA 5



MAGNOLIA 6



MAGNOLIA 7



MAGNOLIA 8

MAGNOLIA 1 with OAK PREMIUM facing layer and TOPAZ stainless steel handle



GREKO			
WALNUT GREKO	ELM GREKO	OAK GREKO	GREY OAK GREKO
SONOMA GREKO	MEDIUM OAK GREKO	GOLDEN OAK GREKO	
SANREMO GREKO	WHITE GREKO ¹⁾	SNOW-WHITE GREKO ¹⁾	
PREMIUM			
WALNUT PREMIUM	GREY MAPLE PREMIUM ⁴⁾	OAK PREMIUM	GRAPHITE ASH PREMIUM ⁴⁾
NATUR OAK PREMIUM ⁴⁾	WHITE BARK PREMIUM	WHITE PREMIUM ¹⁾⁴⁾	
CPL			
WHITE ST CPL ¹⁾³⁾	OAK ST CPL ⁴⁾	GREY OAK ST CPL	VENGE ST CPL
GREY PINE ST CPL	CAPPUCCINO ST CPL ³⁾	LIGHT GREY ST CPL ³⁾	BLACK ST CPL ³⁾
DARK GREEN ST CPL ³⁾	ROYAL BLUE ST CPL ³⁾	ASH GREY ST CPL ³⁾	NEW



CONSTRUCTION

- rebated or non-rebated door leaf made in the STILE panelled technology
- MDF stiles and rails covered with the GREKO, PREMIUM, ST CPL facings or ST CPL laminate with the AntiFinger coating
- glulam laminated stiles covered with HDF and MDF boards ⁴⁾
- 4 mm thick HDF panels with GREKO, CPL or PREMIUM finish
- optional door frame extension panels and a crosshead with pilasters are available for an additional charge, p. 147-149
- the door can be trimmed by a customer, go to p. 145 for details

HARDWARE

- rebated door leaves: three silver 2-pin hinges adjusted horizontally
- three concealed hinges in a non-rebated leaf, silver (optionally black - subject to an additional charge); hinges supplied with and included in the price of the door frame
- lever tumbler lock in a rebated door leaf and a key-locked magnetic lock (lever tumbler lock as an option) in a non-rebated door leaf, thumb turn cylinder, economy, with a silver blockade; optionally, for an additional charge, a black or gold magnetic lock

GLAZING

- tempered 4 mm glass, frosted or clear as a standard and, for an additional charge, laminated VSG 221 safety glass frosted or black plain on both sides
- possibility to change the glazing side to REVERSE (standard glazing for OBVERSE)

AVAILABLE SOLUTIONS (p. 150-161)

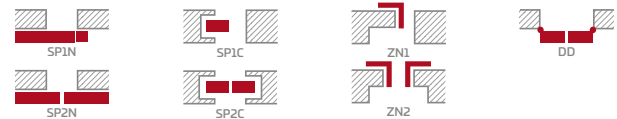

AVAILABLE DOOR LEAF WIDTHS



EXTRA CHARGES

factory pre-drilled through holes for handles (split handles) ordered together with the door leaf

door undercut (p. 145) or air gap undercut

plastic woodgrain sleeves (4 pcs)

round and square metal sleeves (4 pcs); brushed nickel or patina finish in white and black

ventilation grille (only for door leaf widths of 80, 90, 100)

"100" rebated and non-rebated door leaf

VSG 221 laminated safety glass, plain on both sides, frosted or black

metal hinge casings in rebated door leaf
(colour: brushed nickel, patina, glossy chrome, glossy brass, white and black)

drop down seal ²⁾

can be replaced with a black or golden magnetic lock for non-rebated door leaves

magnetic stop (buffer) ²⁾
(available in six colours p. 145)

glulam stiles ⁴⁾

¹⁾ plain white facing imitating a painted surface

²⁾ a stop will not allow a drop down seal and an door undercut to be used, and vice versa

³⁾ special AntiFinger coating to reduce dirt and fingerprints

⁴⁾ glulam stiles covered with HDF and MDF boards available for WHITE PREMIUM, NATUR OAK PREMIUM, GRAPHITE ASH PREMIUM, GREY MAPLE PREMIUM, OAK ST CPL at extra charge

⁵⁾ only for non-rebated door leaves



ARALIA NOLINA EWODIA

REBATED AND NON-REBATED INTERIOR STILE DOORS



ARALIA 1, WHITE BARK PREMIUM facing layer, handle: RUMBA, antibacterial, black matt



ARALIA 1²⁾



NOLINA 1



EWODIA 1²⁾



EWODIA 2²⁾



EWODIA 4²⁾

NOLLINA 1 in WHITE BARK PREMIUM facing layer with TOPAZ black matt handle



CONSTRUCTION

- rebated or non-rebated door leaf made in the STILE panelled technology
- MDF stiles and rails covered with the PREMIUM facing
- glulam laminated stiles covered with HDF and MDF boards²⁾
- 16 mm thick HDF panels with PREMIUM facing layer (vertical grain direction)
- optional door frame extension panels and a crosshead with pilasters are available for an additional charge, p. 147-149
- the door can be trimmed by a customer, go to p. 145 for details

HARDWARE

- rebated door leaves: three silver 2-pin hinges adjusted horizontally
- three concealed hinges in a non-rebated leaf, silver (optionally black - subject to an additional charge); hinges supplied with and included in the price of the door frame
- lever tumbler lock in a rebated door leaf and a key-locked magnetic lock (lever tumbler lock as an option) in a non-rebated door leaf, thumb turn cylinder, economy, with a silver blockade; optionally, for an additional charge, a black or gold magnetic lock

GLAZING

- frosted decormat glass, 4 mm, or custom-made frosted or black VSG 221 laminated safety glass, plain on both sides
- possibility to change the glazing side to REVERSE (standard glazing for OBVERSE)

AVAILABLE SOLUTIONS (p. 150-161)

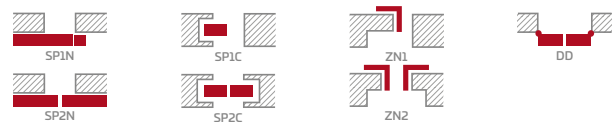

AVAILABLE DOOR LEAF WIDTHS

60 70 80N³⁾ 80 90 100

EXTRA CHARGES

factory pre-drilled through holes for handles (split handles) ordered together with the door leaf

door undercut (p. 145) or air gap undercut

plastic woodgrain sleeves (4 pcs)

round and square metal sleeves (4 pcs); brushed nickel or patina finish in white and black

ventilation grille (only for door leaf widths of 80, 90, 100)

"100" rebated and non-rebated door leaf

VSG 221 laminated safety glass, plain on both sides, frosted or black

metal hinge casings in rebated door leaf
(colour: brushed nickel, patina, glossy chrome, glossy brass, white and black)

drop down seal¹⁾

can be replaced with a black or golden magnetic lock for non-rebated door leaves

magnetic stop (buffer)¹⁾
(available in six colours p. 145)

glulam stiles²⁾

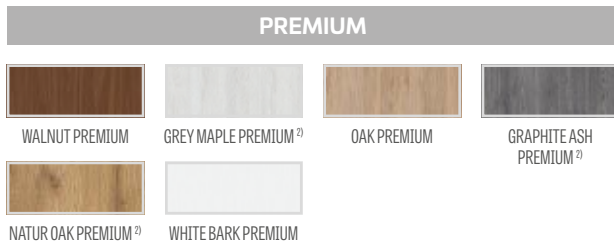

glulam stiles²⁾

¹⁾ a stop will not allow a drop down seal and an door undercut to be used, and vice versa

²⁾ glulam stiles covered with HDF and MDF boards available for an extra charge in ARALIA 1, EWODIA 1, 2, 4 models for NATUR OAK PREMIUM, GRAPHITE ASH PREMIUM, GRAPHITE MAPLE PREMIUM

³⁾ only for non-rebated door leaves



POWOJNIK

REBATED AND NON-REBATED INTERIOR STILE DOORS



POWOJNIK 1, ROYAL BLUE ST CPL facing layer, handle: MOON R SLIM



POWOJNIK 1



POWOJNIK 2



POWOJNIK 3



POWOJNIK 4



POWOJNIK 5

POWJUNKI in ROYAL BLUE ST CPL facing layer with MOON R SLIM handle



CONSTRUCTION

- rebated or non-rebated door leaf made in the STILE panelled technology
- MDF stiles and rails covered with the PREMIUM, ST CPL facings or ST CPL laminate with the AntiFinger coating
- glulam laminated stiles covered with HDF and MDF boards⁴⁾
- 4mm thick HDF panels with CPL or PREMIUM facing
- central crossbars of 22 mm in thickness and a very wide upper and bottom crossbar of 35 mm
- optional door frame extension panels and a crosshead with pilasters are available for an additional charge, p. 147-149
- the door can be trimmed by a customer; go to p. 145 for details

HARDWARE

- rebated door leaves: three silver 2-pin hinges adjusted horizontally
- three concealed hinges in a non-rebated leaf, silver (optionally black - subject to an additional charge); hinges supplied with and included in the price of the door frame
- lever tumbler lock in a rebated door leaf and a key-locked magnetic lock (lever tumbler lock as an option) in a non-rebated door leaf, thumb turn cylinder, economy, with a silver blockade; optionally, for an additional charge, a black or gold magnetic lock

GLAZING

- tempered 4 mm glass, frosted or clear as a standard and, for an additional charge, laminated VSG 221 safety glass frosted or black plain on both sides
- possibility to change the glazing side to REVERSE (standard glazing for OBVERSE)

AVAILABLE SOLUTIONS (p. 150-161)

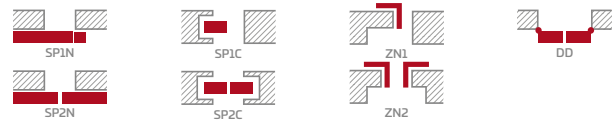

AVAILABLE DOOR LEAF WIDTHS

60 70 80N⁵⁾ 80 90 100

EXTRA CHARGES

factory pre-drilled through holes for handles (split handles) ordered together with the door leaf

door undercut (p. 145) or air gap undercut

plastic woodgrain sleeves (4 pcs)

round and square metal sleeves (4 pcs); brushed nickel or patina finish in white and black

ventilation grille (only for door leaf widths of 80, 90, 100)

"100" rebated and non-rebated door leaf

VSG 221 laminated safety glass, plain on both sides, frosted or black

metal hinge casings in rebated door leaf (colour: brushed nickel, patina, glossy chrome, glossy brass, white and black)

drop down seal²⁾

can be replaced with a black or golden magnetic lock for non-rebated door leaves

magnetic stop (buffer)²⁾ (available in six colours p. 145)

glulam stiles⁴⁾

PREMIUM

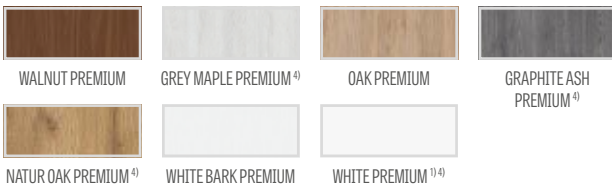

CPL

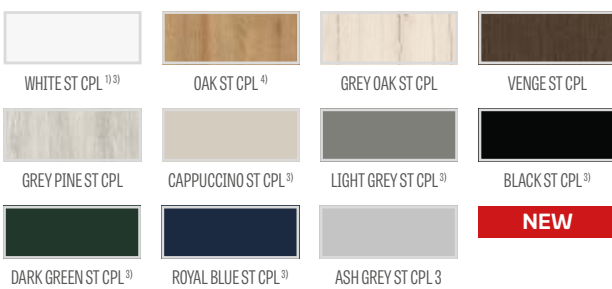

glulam stiles⁴⁾

¹⁾ plain white facing imitating a painted surface

²⁾ a stop will not allow a drop down seal and an door undercut to be used, and vice versa

³⁾ special AntiFinger coating to reduce dirt and fingerprints

⁴⁾ glulam stiles covered with HDF and MDF boards available for WHITE PREMIUM, NATUR OAK PREMIUM, GRAPHITE ASH PREMIUM, GREY MAPLE PREMIUM, OAK ST CPL at extra charge

⁵⁾ only for non-rebated door leaves



JUKA

REBATED AND NON-REBATED INTERIOR STILE DOORS



JUKA 4, DARK GREEN ST CPL facing layer, handle: BELLA SLIM, glossy brass



JUKA 1



JUKA 2



JUKA 3



JUKA 4



JUKA 5



JUKA 6



JUKA 7



JUKA 8

JUKA 1 in DARK GREEN ST CPL facing layer with BELLA SLIM handle, glossy brass



GREKO			
WALNUT GREKO	ELM GREKO	OAK GREKO	GREY OAK GREKO
SONOMA GREKO	MEDIUM OAK GREKO	GOLDEN OAK GREKO	
SANREMO GREKO	WHITE GREKO ¹⁾	SNOW-WHITE GREKO ¹⁾	
PREMIUM			
WALNUT PREMIUM	GREY MAPLE PREMIUM ⁴⁾	OAK PREMIUM	GRAPHITE ASH PREMIUM ⁴⁾
NATUR OAK PREMIUM ⁴⁾	WHITE BARK PREMIUM	WHITE PREMIUM ^{1) 4)}	
CPL			
WHITE ST CPL ^{1) 3)}	OAK ST CPL ⁴⁾	GREY OAK ST CPL	VENGE ST CPL
GREY PINE ST CPL	CAPPUCCINO ST CPL ³⁾	LIGHT GREY ST CPL ³⁾	BLACK ST CPL ³⁾
DARK GREEN ST CPL ³⁾	ROYAL BLUE ST CPL ³⁾	ASH GREY ST CPL ³⁾	NEW



CONSTRUCTION

- rebated or non-rebated door leaf made in the STILE panelled technology
- MDF stiles and rails covered with the GREKO, PREMIUM, ST CPL facings or ST CPL laminate with the AntiFinger coating
- glulam laminated stiles covered with HDF and MDF boards ⁴⁾
- 4 mm thick HDF panels with GREKO, CPL or PREMIUM finish
- optional door frame extension panels and a crosshead with pilasters are available for an additional charge, p. 147-149
- the door can be trimmed by a customer, go to p. 145 for details

HARDWARE

- rebated door leaves: three silver 2-pin hinges adjusted horizontally
- three concealed hinges in a non-rebated leaf, silver (optionally black - subject to an additional charge); hinges supplied with and included in the price of the door frame
- lever tumbler lock in a rebated door leaf and a key-locked magnetic lock (lever tumbler lock as an option) in a non-rebated door leaf, thumb turn cylinder, economy, with a silver blockade; optionally, for an additional charge, a black or gold magnetic lock

GLAZING

- tempered 4 mm glass, frosted or clear as a standard and, for an additional charge, laminated VSG 221 safety glass frosted or black plain on both sides
- possibility to change the glazing side to REVERSE (standard glazing for OBVERSE)

AVAILABLE SOLUTIONS (p. 150-161)

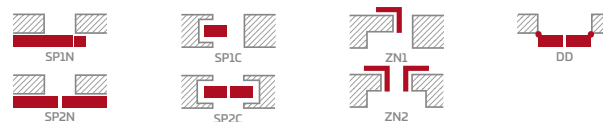

AVAILABLE DOOR LEAF WIDTHS

- 60 70 80N ⁵⁾ 80 90 100

EXTRA CHARGES

factory pre-drilled through holes for handles (split handles) ordered together with the door leaf

door undercut (p. 145) or air gap undercut

plastic woodgrain sleeves (4 pcs)

round and square metal sleeves (4 pcs); brushed nickel or patina finish in white and black

ventilation grille (only for door leaf widths of 80, 90, 100)

"100" rebated and non-rebated door leaf

VSG 221 laminated safety glass, plain on both sides, frosted or black

metal hinge casings in the rebated door leaf (brushed nickel, patina, polished chrome, polished brass, white and black)

drop down seal ²⁾

can be replaced with a black or golden magnetic lock for non-rebated door leaves

magnetic stop (buffer) ²⁾
(available in six colours p. 145)

glulam stiles ⁴⁾

¹⁾ plain white facing imitating a painted surface

²⁾ a stop will not allow a drop down seal and an door undercut to be used, and vice versa

³⁾ special AntiFinger coating to reduce dirt and fingerprints

⁴⁾ glulam stiles covered with HDF and MDF boards available for WHITE PREMIUM, NATUR OAK PREMIUM, GRAPHITE ASH PREMIUM, GREY MAPLE PREMIUM, OAK ST CPL at extra charge

⁵⁾ only for non-rebated door leaves



FORSYCJA

REBATED AND NON-REBATED INTERIOR STILE DOORS



FORSYCJA 1, WHITE GREKO facing layer, door frame: OAK PREMIUM facing layer, handle: BELLA SLIM, black matt



FORSYCJA 1



FORSYCJA 2



FORSYCJA 3



FORSYCJA 4



FORSYCJA 5



FORSYCJA 6



FORSYCJA 7



FORSYCJA 8

FORSVCJA 4 with WHITE GREKO laminate and a black matt CUBE handle



CONSTRUCTION

- rebated or non-rebated door leaf made in the STILE panelled technology
- MDF stiles and rails covered with the GREKO, PREMIUM, ST CPL facings or ST CPL laminate with the AntiFinger coating
- glulam laminated stiles covered with HDF and MDF boards⁴⁾
- 4 mm thick HDF panels with GREKO, CPL or PREMIUM finish
- optional door frame extension panels and a crosshead with pilasters are available for an additional charge, p. 147-149
- the door can be trimmed by a customer, go to p. 145 for details

HARDWARE

- rebated door leaves: three silver 2-pin hinges adjusted horizontally
- three concealed hinges in a non-rebated leaf, silver (optionally black - subject to an additional charge); hinges supplied with and included in the price of the door frame
- lever tumbler lock in a rebated door leaf and a key-locked magnetic lock (lever tumbler lock as an option) in a non-rebated door leaf, thumb turn cylinder, economy, with a silver blockade; optionally, for an additional charge, a black or gold magnetic lock

GLAZING

- tempered 4 mm glass, frosted or clear as a standard and, for an additional charge, laminated VSG 221 safety glass frosted or black plain on both sides
- possibility to change the glazing side to REVERSE (standard glazing for OBRVERSE)

AVAILABLE SOLUTIONS (p. 150-161)

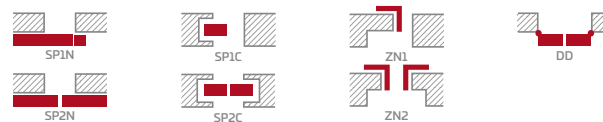

AVAILABLE DOOR LEAF WIDTHS



EXTRA CHARGES

factory pre-drilled through holes for handles (split handles) ordered together with the door leaf

door undercut (p. 145) or air gap undercut

plastic woodgrain sleeves (4 pcs)

round and square metal sleeves (4 pcs); brushed nickel or patina finish in white and black

ventilation grille (only for door leaf widths of 80, 90, 100)

"100" rebated and non-rebated door leaf

VSG 221 laminated safety glass, plain on both sides, frosted or black

metal hinge casings in the rebated door leaf (brushed nickel, patina, polished chrome, polished brass, white and black)

drop down seal²⁾

can be replaced with a black or golden magnetic lock for non-rebated door leaves

magnetic stop (buffer)²⁾
(available in six colours p. 145)

glulam stiles⁴⁾

GREKO

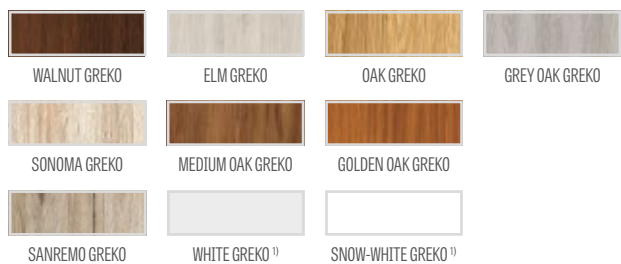

PREMIUM

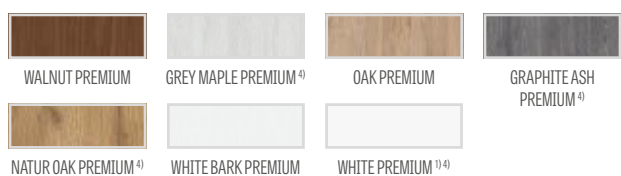

CPL



¹⁾ plain white facing imitating a painted surface

²⁾ a stop will not allow a drop down seal and an door undercut to be used, and vice versa

³⁾ special AntiFinger coating to reduce dirt and fingerprints

⁴⁾ glulam stiles covered with HDF and MDF boards available for WHITE PREMIUM, NATUR OAK PREMIUM, GRAPHITE ASH PREMIUM, GREY MAPLE PREMIUM, OAK ST CPL at extra charge

⁵⁾ only for non-rebated door leaves



LAWENDA

REBATED AND NON-REBATED INTERIOR STILE DOORS



LAWENDA 7, facing layer: OAK GREKO, DECO handle



LAWENDA 1



LAWENDA 2



LAWENDA 3



LAWENDA 4



LAWENDA 5



LAWENDA 6



LAWENDA 7



LAWENDA 8



LAWENDA 9

LAWENDA 1 with OAK GREKO laminate and a DECO Handle



CONSTRUCTION

- rebated or non-rebated door leaf made in the STILE panelled technology
- MDF stiles and rails covered with the GREKO, PREMIUM, ST CPL facings or ST CPL laminate with the AntiFinger coating
- glulam laminated stiles covered with HDF and MDF boards⁴⁾
- 4 mm thick HDF panels with GREKO, CPL or PREMIUM finish
- optional door frame extension panels and a crosshead with pilasters are available for an additional charge, p. 147-149
- the door can be trimmed by a customer, go to p. 145 for details

HARDWARE

- rebated door leaves: three silver 2-pin hinges adjusted horizontally
- three concealed hinges in a non-rebated leaf, silver (optionally black - subject to an additional charge); hinges supplied with and included in the price of the door frame
- lever tumbler lock in a rebated door leaf and a key-locked magnetic lock (lever tumbler lock as an option) in a non-rebated door leaf, thumb turn cylinder, economy, with a silver blockade; optionally, for an additional charge, a black or gold magnetic lock

GLAZING

- tempered 4 mm glass, frosted or clear as a standard and, for an additional charge, laminated VSG 221 safety glass frosted or black plain on both sides
- possibility to change the glazing side to REVERSE (standard glazing for OBVERSE)

AVAILABLE SOLUTIONS (p. 150-161)

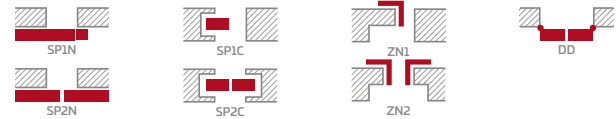

AVAILABLE DOOR LEAF WIDTHS

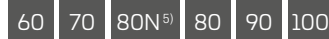

EXTRA CHARGES

factory pre-drilled through holes for handles (split handles) ordered together with the door leaf

door undercut (p. 145) or air gap undercut

plastic woodgrain sleeves (4 pcs)

round and square metal sleeves (4 pcs); brushed nickel or patina finish in white and black

ventilation grille (only for door leaf widths of 80, 90, 100)

"100" rebated and non-rebated door leaf

VSG 221 laminated safety glass, plain on both sides, frosted or black

metal hinge casings in the rebated door leaf (brushed nickel, patina, polished chrome, polished brass, white and black)

drop down seal²⁾

can be replaced with a black or golden magnetic lock for non-rebated door leaves

magnetic stop (buffer)²⁾
(available in six colours p. 145)

glulam stiles⁴⁾

GREKO

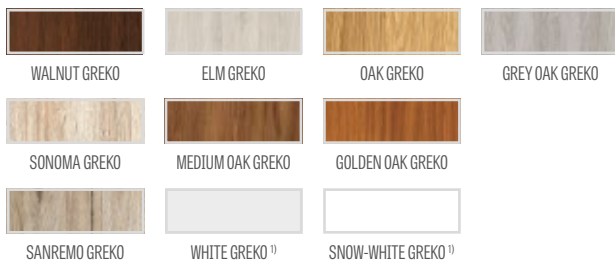

PREMIUM

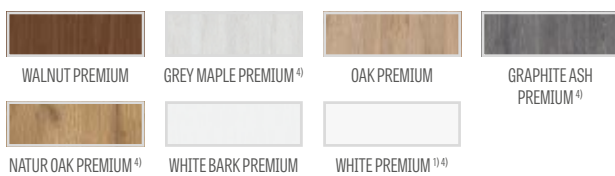

CPL

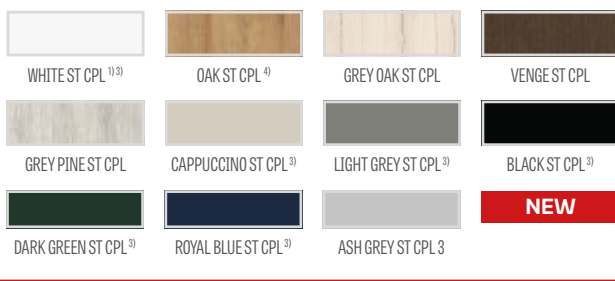

glulam stiles⁴⁾

¹⁾ plain white facing imitating a painted surface

²⁾ a stop will not allow a drop down seal and an door undercut to be used, and vice versa

³⁾ special AntiFinger coating to reduce dirt and fingerprints

⁴⁾ glulam stiles covered with HDF and MDF boards available for WHITE PREMIUM, NATUR OAK PREMIUM, GRAPHITE ASH PREMIUM, GREY MAPLE PREMIUM, OAK ST CPL at extra charge

⁵⁾ only for non-rebated door leaves



IRYS

REBATED AND NON-REBATED INTERIOR STILE DOORS



IRYS 1, WHITE ST CPL facing layer, handle: CUBE, black matt



IRYS 1



IRYS 2



IRYS 3



IRYS 4



IRYS 5



IRYS 6



IRYS 7



IRYS 8

IRYS 1 in ASH GREY ST CPL facing layer with QUANTA FIT handle, black matt



CONSTRUCTION

- rebated or non-rebated door leaf made in the STILE panelled technology
- MDF stiles and rails covered with the GREKO, PREMIUM, ST CPL facings or ST CPL laminate with the AntiFinger coating
- glulam laminated stiles covered with HDF and MDF boards⁴⁾
- 4 mm thick HDF panels with GREKO, CPL or PREMIUM finish
- optional door frame extension panels and a crosshead with pilasters are available for an additional charge, p. 147-149
- the door can be trimmed by a customer, go to p. 145 for details

HARDWARE

- rebated door leaves: three silver 2-pin hinges adjusted horizontally
- three concealed hinges in a non-rebated leaf, silver (optionally black - subject to an additional charge); hinges supplied with and included in the price of the door frame
- lever tumbler lock in a rebated door leaf and a key-locked magnetic lock (lever tumbler lock as an option) in a non-rebated door leaf, thumb turn cylinder, economy, with a silver blockade; optionally, for an additional charge, a black or gold magnetic lock

GLAZING

- tempered 4 mm glass, frosted or clear as a standard and, for an additional charge, laminated VSG 221 safety glass frosted or black plain on both sides
- possibility to change the glazing side to REVERSE (standard glazing for OBVERSE)

AVAILABLE SOLUTIONS (p. 150-161)

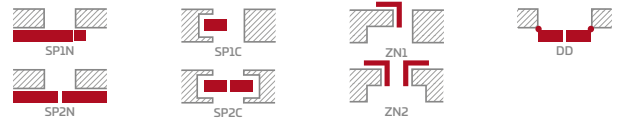

AVAILABLE DOOR LEAF WIDTHS

60 70 80N⁵⁾ 80 90 100

EXTRA CHARGES

factory pre-drilled through holes for handles (split handles) ordered together with the door leaf

door undercut (p. 145) or air gap undercut

plastic woodgrain sleeves (4 pcs)

round and square metal sleeves (4 pcs); brushed nickel or patina finish in white and black

ventilation grille (only for door leaf widths of 80, 90, 100)

"100" rebated and non-rebated door leaf

VSG 221 laminated safety glass, plain on both sides, frosted or black

metal hinge casings in rebated door leaf
(colour: brushed nickel, patina, glossy chrome, glossy brass, white and black)

drop down seal²⁾

can be replaced with a black or golden magnetic lock for non-rebated door leaves

magnetic stop (buffer)²⁾
(available in six colours p. 145)

glulam stiles⁴⁾

GREKO

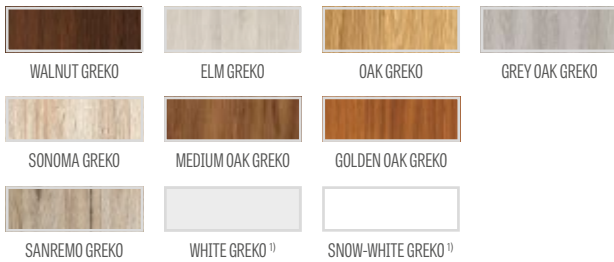

PREMIUM

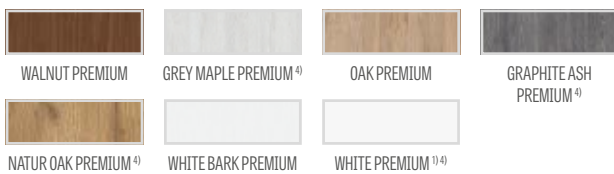

CPL



glulam stiles⁴⁾

¹⁾ plain white facing imitating a painted surface

²⁾ a stop will not allow a drop down seal and an door undercut to be used, and vice versa

³⁾ special AntiFinger coating to reduce dirt and fingerprints

⁴⁾ glulam stiles covered with HDF and MDF boards available for WHITE PREMIUM, NATUR OAK PREMIUM, GRAPHITE ASH PREMIUM, GREY MAPLE PREMIUM, OAK ST CPL at extra charge

⁵⁾ only for non-rebated door leaves



DAGLEZJA

REBATED AND NON-REBATED INTERIOR STILE DOORS



DAGLEZJA 1, GREY PINE ST CPL, handle: QUANTA FIT, black matt



DAGLEZJA 1



DAGLEZJA 2



DAGLEZJA 3



DAGLEZJA 4



DAGLEZJA 5



DAGLEZJA 6



DAGLEZJA 7



DAGLEZJA 8

DAGLEZIA 6 in GREY PINE ST CPL facing layer and QUANTA FIT handle, black matt



CONSTRUCTION

- rebated or non-rebated door leaf made in the STILE panelled technology
- MDF stiles and rails covered with the GREKO, PREMIUM, ST CPL facings or ST CPL laminate with the AntiFinger coating
- glulam laminated stiles covered with HDF and MDF boards⁴⁾
- 4 mm thick HDF panels with GREKO, CPL or PREMIUM finish
- very wide crossbar
- optional door frame extension panels and a crosshead with pilasters are available for an additional charge, p. 147-149
- the door can be trimmed by a customer; go to p. 145 for details

HARDWARE

- rebated door leaves: three silver 2-pin hinges adjusted horizontally
- three concealed hinges in a non-rebated leaf, silver (optionally black - subject to an additional charge); hinges supplied with and included in the price of the door frame
- lever tumbler lock in a rebated door leaf and a key-locked magnetic lock (lever tumbler lock as an option) in a non-rebated door leaf, thumb turn cylinder, economy, with a silver blockade; optionally, for an additional charge, a black or gold magnetic lock

GLAZING

- tempered 4 mm glass, frosted or clear as a standard and, for an additional charge, laminated VSG 221 safety glass frosted or black plain on both sides
- possibility to change the glazing side to REVERSE (standard glazing for OBVERSE)

AVAILABLE SOLUTIONS (p. 150-161)

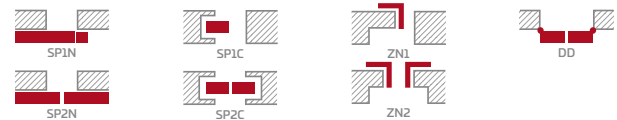

AVAILABLE DOOR LEAF WIDTHS

60 70 80N⁵⁾ 80 90 100

EXTRA CHARGES

factory pre-drilled through holes for handles (split handles) ordered together with the door leaf

door undercut (p. 145) or air gap undercut

plastic woodgrain sleeves (4 pcs)

round and square metal sleeves (4 pcs); brushed nickel or patina finish in white and black

ventilation grille (only for door leaf widths of 80, 90, 100)

"100" rebated and non-rebated door leaf

VSG 221 laminated safety glass, plain on both sides, frosted or black

metal hinge casings in rebated door leaf
(colour: brushed nickel, patina, glossy chrome, glossy brass, white and black)

drop down seal²⁾

can be replaced with a black or golden magnetic lock for non-rebated door leaves

magnetic stop (buffer)²⁾
(available in six colours p. 145)

glulam stiles⁴⁾

GREKO

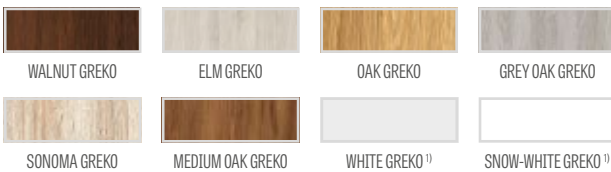

PREMIUM

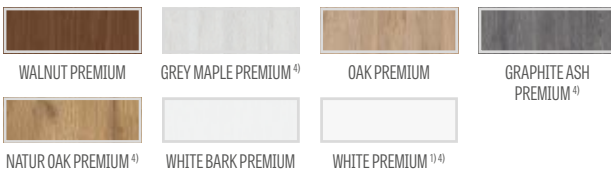

CPL



glulam stiles⁴⁾

¹⁾ plain white facing imitating a painted surface

²⁾ a stop will not allow a drop down seal and an door undercut to be used, and vice versa

³⁾ special AntiFinger coating to reduce dirt and fingerprints

⁴⁾ glulam stiles covered with HDF and MDF boards available for WHITE PREMIUM, NATUR OAK PREMIUM, GRAPHITE ASH PREMIUM, GREY MAPLE PREMIUM, OAK ST CPL at extra charge

⁵⁾ only for non-rebated door leaves



FREZJA

REBATED AND NON-REBATED INTERIOR STILE DOORS



FREZJA 1, LIGHT GREY ST CPL facing layer, VSG black glass, handle: QUANTA FIT, black matt



FREZJA 1



FREZJA 2



FREZJA 3



FREZJA 4



FREZJA 2



FREZJA 4



FREZJA 6



FREZJA 5



FREZJA 6



FREZJA 7³⁾



FREZJA 8²⁾



FREZJA 8
Air gap undercut

²⁾ FREZJA 8 – 8 mm thick glazing

³⁾ FREZJA 7 – available with a mirror only

The other side is covered with a facing layer.
Obverse – a mirror fitted on the hinge side (as shown in the photo)

FREZJA 1 in LIGHT GREY ST CPL facing layer with QUANTA FIT handle, black matt



CONSTRUCTION

- rebated or non-rebated door leaf made in the STILE panelled technology
- MDF stiles and rails covered with the GREKO, PREMIUM, ST CPL facings or ST CPL laminate with the AntiFinger coating
- glulam laminated stiles covered with HDF and MDF boards⁶⁾
- 16 mm thick HDF panels (also a 4 mm panel for the FREZJA 2 & 6 models) covered with the GREKO, CPL or PREMIUM facing; FREZJA 7 is available with a mirror only
- optional door frame extension panels and a crosshead with pilasters are available for an additional charge, p. 147-149
- the door can be trimmed by a customer; go to p. 145 for details

HARDWARE

- rebated door leaves: three silver 2-pin hinges adjusted horizontally
- three concealed hinges in a non-rebated leaf, silver (optionally black - subject to an additional charge); hinges supplied with and included in the price of the door frame
- lever tumbler lock in a rebated door leaf and a key-locked magnetic lock (lever tumbler lock as an option) in a non-rebated door leaf, thumb turn cylinder, economy, with a silver blockade; optionally, for an additional charge, a black or gold magnetic lock

GLAZING

- frosted or clear tempered glass or a mirror fitted on one side (only Frezja 7) as standard, and custom-made frosted or black VSG 221 laminated safety glass, plain on both sides (not in FREZJA 7 & 8)
- possibility to change the glazing side to REVERSE (standard glazing for OBVERSE)
- fixed glazing widths: FREZJA 1 – 140 mm, FREZJA 5 – 70 mm



AVAILABLE SOLUTIONS 3) (p. 150-161)

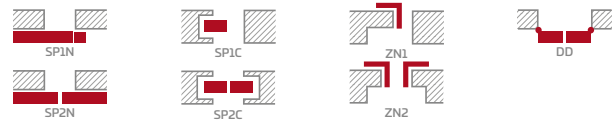

AVAILABLE DOOR LEAF WIDTHS

60 70 80N⁷⁾ 80 90 100

EXTRA CHARGES

factory pre-drilled through holes for handles (split handles) ordered together with the door leaf

door undercut (p. 145) or air gap undercut

plastic woodgrain sleeves (4 pcs)²⁾

round and square metal round and square metal sleeves²⁾ (4 pcs.); brushed nickel or patina finish white and black

ventilation grille²⁾ (only for door leaf widths of: 80, 90, 100)

"100" rebated and non-rebated door leaf

VSG 221 laminated safety glass, plain on both sides, frosted or black

metal hinge casings in the rebated door leaf (brushed nickel, patina, polished chrome, polished brass, white and black)

drop down seal⁴⁾ (not for FREZJA 8)

can be replaced with a black or golden magnetic lock for non-rebated door leaves

magnetic stop (buffer)⁴⁾ (available in six colours p. 145)

glulam stiles⁶⁾

¹⁾ plain white facing imitating a painted surface

²⁾ not available in FREZJA 8

³⁾ FREZJA 8 is not available for sliding systems

⁴⁾ a stop will not allow a drop down seal and a door undercut to be used, and vice versa

⁵⁾ special AntiFinger coating to reduce dirt and fingerprints

⁶⁾ glulam stiles covered with HDF and MDF boards available for WHITE PREMIUM, NATUR OAK PREMIUM, GRAPHITE ASH PREMIUM, GREY MAPLE PREMIUM, OAK ST CPL at extra charge

⁷⁾ only for non-rebated door leaves



DEBECJA

REBATED AND NON-REBATED INTERIOR STILE DOORS



DEBECJA 1, CAPPUCCINO ST CPL facing layer, handle: BELLA SLIM, round, glossy brass

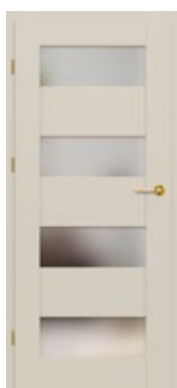

DEBECJA 1

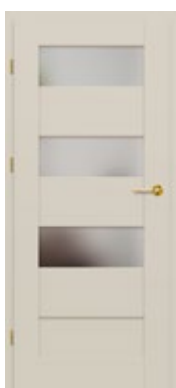

DEBECJA 2



DEBECJA 3

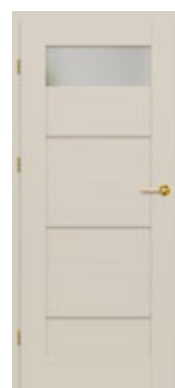

DEBECJA 4

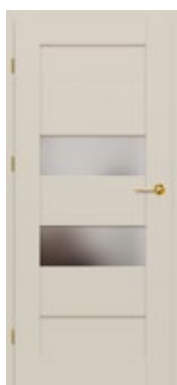

DEBECJA 5



DEBECJA 6



DEBECJA 7

DEBECIA7 in CAPPUCCINO ST CPL facing layer with BELLA SLIM round handle, glossy brass



CONSTRUCTION

- rebated or non-rebated door leaf made in the STILE panelled technology
- MDF stiles and rails covered with the GREKO, PREMIUM, ST CPL facings or ST CPL laminate with the AntiFinger coating
- glulam laminated stiles covered with HDF and MDF boards⁴⁾
- 4 mm thick HDF panels with GREKO, CPL or PREMIUM finish
- very wide crossbar
- optional door frame extension panels and a crosshead with pilasters are available for an additional charge, p. 147-149
- the door can be trimmed by a customer; go to p. 145 for details

HARDWARE

- rebated door leaves: three silver 2-pin hinges adjusted horizontally
- three concealed hinges in a non-rebated leaf, silver (optionally black - subject to an additional charge); hinges supplied with and included in the price of the door frame
- lever tumbler lock in a rebated door leaf and a key-locked magnetic lock (lever tumbler lock as an option) in a non-rebated door leaf, thumb turn cylinder, economy, with a silver blockade; optionally, for an additional charge, a black or gold magnetic lock

GLAZING

- tempered 4 mm glass, frosted or clear as a standard and, for an additional charge, laminated VSG 221 safety glass frosted or black plain on both sides
- possibility to change the glazing side to REVERSE (standard glazing for OBVERSE)

AVAILABLE SOLUTIONS (p. 150-161)

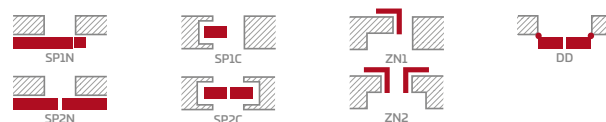

AVAILABLE DOOR LEAF WIDTHS

60 70 80N⁵⁾ 80 90 100

EXTRA CHARGES

factory pre-drilled through holes for handles (split handles) ordered together with the door leaf

door undercut (p. 145) or air gap undercut

plastic woodgrain sleeves (4 pcs)

round and square metal sleeves (4 pcs); brushed nickel or patina finish in white and black

ventilation grille (only for door leaf widths of 80, 90, 100)

"100" rebated and non-rebated door leaf

VSG 221 laminated safety glass, plain on both sides, frosted or black

metal hinge casings in rebated door leaf
(colour: brushed nickel, patina, glossy chrome, glossy brass, white and black)

drop down seal²⁾

can be replaced with a black or golden magnetic lock for non-rebated door leaves

magnetic stop (buffer)²⁾
(available in six colours p. 145)

glulam stiles⁴⁾

GREKO

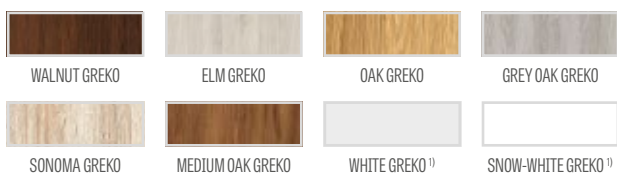

PREMIUM

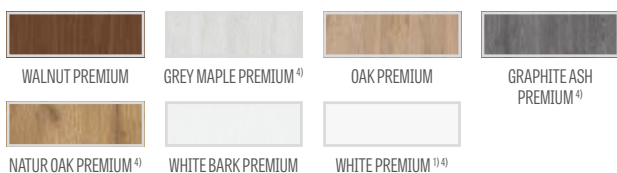

CPL



glulam stiles⁴⁾

¹⁾ plain white facing imitating a painted surface

²⁾ a stop will not allow a drop down seal and an door undercut to be used, and vice versa

³⁾ special AntiFinger coating to reduce dirt and fingerprints

⁴⁾ glulam stiles covered with HDF and MDF boards available for WHITE PREMIUM, NATUR OAK PREMIUM, GRAPHITE ASH PREMIUM, GREY MAPLE PREMIUM, OAK ST CPL at extra charge

⁵⁾ only for non-rebated door leaves



SURMIA

REBATED AND NON-REBATED INTERIOR STILE DOORS



SURMIA 1, VENGE ST CPL facing layer, handle: CUBE, brushed matt chrome



SURMIA 1



SURMIA 2



SURMIA 3



SURMIA 4

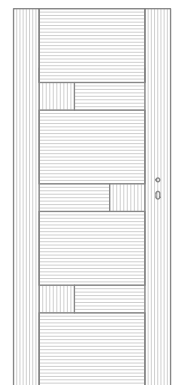

GRAIN PATTERN *)

SURMIA 4 in VENGÉ ST CPL facing layer with CUBE handle, brushed matt chrome



CONSTRUCTION

- rebated or non-rebated door leaf made in the STILE panellèd technology
- MDF stiles and rails covered with the PREMIUM, ST CPL facings or ST CPL laminate with the AntiFinger coating
- glulam laminated stiles covered with HDF and MDF boards⁴⁾
- 22 mm and 4 mm thick HDF panels with CPL or PREMIUM finish
- 35 mm thick, very wide crossbar
- optional door frame extension panels and a crosshead with pilasters are available for an additional charge, p. 147-149
- the door can be trimmed by a customer, go to p. 145 for details

HARDWARE

- rebated door leaves: three silver 2-pin hinges adjusted horizontally
- three concealed hinges in a non-rebated leaf, silver (optionally black - subject to an additional charge); hinges supplied with and included in the price of the door frame
- lever tumbler lock in a rebated door leaf and a key-locked magnetic lock (lever tumbler lock as an option) in a non-rebated door leaf, thumb turn cylinder, economy, with a silver blockade; optionally, for an additional charge, a black or gold magnetic lock

GLAZING

- tempered 4 mm glass, frosted or clear as a standard and, for an additional charge, laminated VSG 221 safety glass frosted or black plain on both sides
- possibility to change the glazing side to REVERSE (standard glazing for OBVERSE)

AVAILABLE SOLUTIONS (p. 150-161)

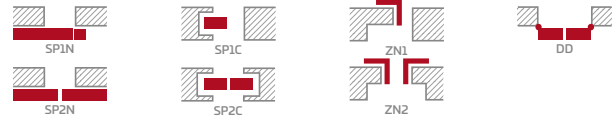

AVAILABLE DOOR LEAF WIDTHS

60 70 80N⁵⁾ 80 90 100

EXTRA CHARGES

factory pre-drilled through holes for handles (split handles) ordered together with the door leaf

door undercut (p. 145) or air gap undercut

plastic woodgrain sleeves (4 pcs)

round and square metal sleeves (4 pcs); brushed nickel or patina finish in white and black

ventilation grille (only for door leaf widths of 80, 90, 100)

"100" rebated and non-rebated door leaf

VSG 221 laminated safety glass, plain on both sides, frosted or black

metal hinge casings in rebated door leaf
(colour: brushed nickel, patina, glossy chrome, glossy brass, white and black)

drop down seal²⁾

can be replaced with a black or golden magnetic lock for non-rebated door leaves

magnetic stop (buffer)²⁾
(available in six colours p. 145)

glulam stiles⁴⁾

PREMIUM

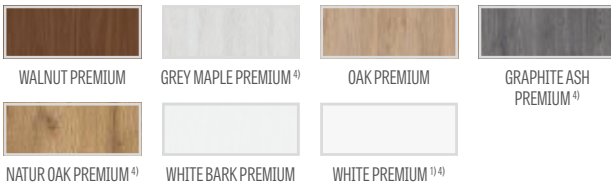

CPL

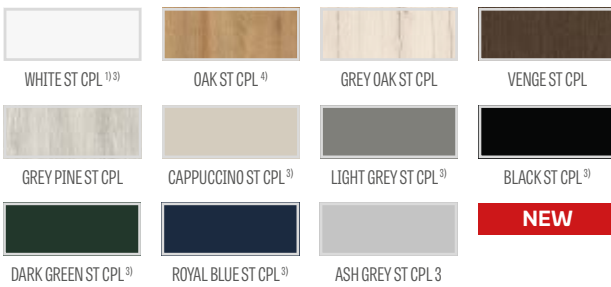

glulam stiles⁴⁾

¹⁾ plain white facing imitating a painted surface

²⁾ a stop will not allow a drop down seal and an door undercut to be used, and vice versa

³⁾ special AntiFinger coating to reduce dirt and fingerprints

⁴⁾ glulam stiles covered with HDF and MDF boards available for WHITE PREMIUM, NATUR OAK PREMIUM, GRAPHITE ASH PREMIUM, GREY MAPLE PREMIUM, OAK ST CPL at extra charge

⁵⁾ only for non-rebated door leaves



BERBERYS

REBATED AND NON-REBATED INTERIOR STILE DOORS



BERBERYS 1, WALNUT PREMIUM, handle: CUBE, brushed matt chrome



BERBERYS 1



BERBERYS 2

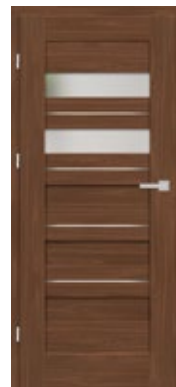

BERBERYS 3

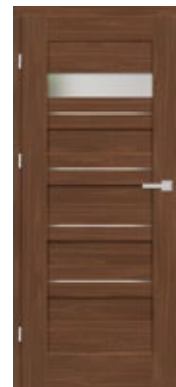

BERBERYS 4



BERBERYS 5



BERBERYS 6



BERBERYS 7



BERBERYS 8

BERBERYS 1 in WALNUT PREMIUM facing layer with CUBE handle, brushed matt chrome



GREKO			
WALNUT GREKO	ELM GREKO	OAK GREKO	GREY OAK GREKO
SONOMA GREKO	MEDIUM OAK GREKO	GOLDEN OAK GREKO	
SANREMO GREKO	WHITE GREKO ¹⁾	SNOW-WHITE GREKO ¹⁾	
PREMIUM			
WALNUT PREMIUM	GREY MAPLE PREMIUM ⁴⁾	OAK PREMIUM	GRAPHITE ASH PREMIUM ⁴⁾
NATUR OAK PREMIUM ⁴⁾	WHITE BARK PREMIUM	WHITE PREMIUM ^{1) 4)}	
CPL			
WHITE ST CPL ^{1) 3)}	OAK ST CPL ⁴⁾	GREY OAK ST CPL	VENGE ST CPL
GREY PINE ST CPL	CAPPUCCINO ST CPL ³⁾	LIGHT GREY ST CPL ³⁾	BLACK ST CPL ³⁾
			NEW
DARK GREEN ST CPL ³⁾	ROYAL BLUE ST CPL ³⁾	ASH GREY ST CPL ³⁾	



CONSTRUCTION

- rebated or non-rebated door leaf made in the STILE panelled technology
- MDF stiles and rails covered with the GREKO, PREMIUM, ST CPL facings or ST CPL laminate with the AntiFinger coating
- glulam laminated stiles covered with HDF and MDF boards ⁴⁾
- 4 mm thick HDF panels with GREKO, CPL or PREMIUM finish
- brushed aluminium insert profiles
- optional door frame extension panels and a crosshead with pilasters are available for an additional charge, p. 147-149
- the door can be trimmed by a customer; go to p. 145 for details

HARDWARE

- rebated door leaves: three silver 2-pin hinges adjusted horizontally
- three concealed hinges in a non-rebated leaf, silver (optionally black - subject to an additional charge); hinges supplied with and included in the price of the door frame
- lever tumbler lock in a rebated door leaf and a key-locked magnetic lock (lever tumbler lock as an option) in a non-rebated door leaf, thumb turn cylinder, economy, with a silver blockade; optionally, for an additional charge, a black or gold magnetic lock

GLAZING

- tempered 4 mm glass, frosted or clear as a standard and, for an additional charge, laminated VSG 221 safety glass frosted or black plain on both sides
- possibility to change the glazing side to REVERSE (standard glazing for OBVERSE)

AVAILABLE SOLUTIONS (p. 150-161)

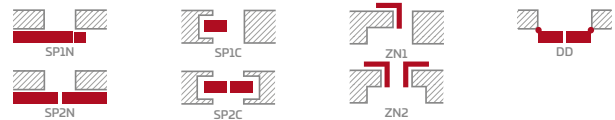

AVAILABLE DOOR LEAF WIDTHS



EXTRA CHARGES

factory pre-drilled through holes for handles (split handles) ordered together with the door leaf

door undercut (p. 145) or air gap undercut

plastic woodgrain sleeves (4 pcs)

round and square metal sleeves (4 pcs); brushed nickel or patina finish in white and black

ventilation grille (only for door leaf widths of 80, 90, 100)

"100" rebated and non-rebated door leaf

VSG 221 laminated safety glass, plain on both sides, frosted or black

metal hinge casings in rebated door leaf
(colour: brushed nickel, patina, glossy chrome, glossy brass, white and black)

drop down seal ²⁾

can be replaced with a black or golden magnetic lock for non-rebated door leaves

magnetic stop (buffer) ²⁾
(available in six colours p. 145)

glulam stiles ⁴⁾

¹⁾ plain white facing imitating a painted surface

²⁾ a stop will not allow a drop down seal and an door undercut to be used, and vice versa

³⁾ special AntiFinger coating to reduce dirt and fingerprints

⁴⁾ glulam stiles covered with HDF and MDF boards available for WHITE PREMIUM, NATUR OAK PREMIUM, GRAPHITE ASH PREMIUM, GREY MAPLE PREMIUM, OAK ST CPL at extra charge

⁵⁾ only for non-rebated door leaves



FLOKS

REBATED AND NON-REBATED INTERIOR STILE DOORS



FLOKS 8, facing layer: OAK ST CPL, CUBE handle, brushed matt chrome



FLOKS 1



FLOKS 2



FLOKS 3

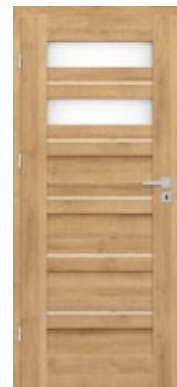

FLOKS 4



FLOKS 5



FLOKS 6



FLOKS 7

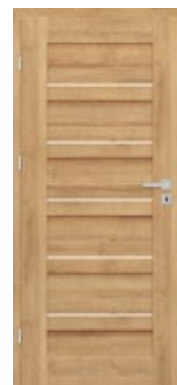

FLOKS 8

FLOKS 1 in OAK ST CPL facing layer with CUBE handle, brushed matt chrome



GREKO			
WALNUT GREKO	ELM GREKO	OAK GREKO	GREY OAK GREKO
SONOMA GREKO	MEDIUM OAK GREKO	GOLDEN OAK GREKO	
SANREMO GREKO	WHITE GREKO ¹⁾	SNOW-WHITE GREKO ¹⁾	
PREMIUM			
WALNUT PREMIUM	GREY MAPLE PREMIUM ⁴⁾	OAK PREMIUM	GRAPHITE ASH PREMIUM ⁴⁾
NATUR OAK PREMIUM ⁴⁾	WHITE BARK PREMIUM	WHITE PREMIUM ^{1) 4)}	
CPL			
WHITE ST CPL ^{1) 3)}	OAK ST CPL ⁴⁾	GREY OAK ST CPL	VENGE ST CPL
GREY PINE ST CPL	CAPPUCCINO ST CPL ³⁾	LIGHT GREY ST CPL ³⁾	BLACK ST CPL ³⁾
			NEW
DARK GREEN ST CPL ³⁾	ROYAL BLUE ST CPL ³⁾	ASH GREY ST CPL 3	



glulam stiles ⁴⁾

CONSTRUCTION

- rebated or non-rebated door leaf made in the STILE panelled technology
- MDF stiles and rails covered with the GREKO, PREMIUM, ST CPL facings or ST CPL laminate with the AntiFinger coating
- glulam laminated stiles covered with HDF and MDF boards ⁴⁾
- 4mm thick HDF panels with GREKO, CPL or PREMIUM facing layer
- brushed aluminium insert profiles
- optional door frame extension panels and a crosshead with pilasters are available for an additional charge, p. 147-149
- the door can be trimmed by a customer; go to p. 145 for details

HARDWARE

- rebated door leaves: three silver 2-pin hinges adjusted horizontally
- three concealed hinges in a non-rebated leaf, silver (optionally black - subject to an additional charge); hinges supplied with and included in the price of the door frame
- lever tumbler lock in a rebated door leaf and a key-locked magnetic lock (lever tumbler lock as an option) in a non-rebated door leaf, thumb turn cylinder, economy, with a silver blockade; optionally, for an additional charge, a black or gold magnetic lock

GLAZING

- tempered 4 mm glass, frosted or clear as a standard and, for an additional charge, laminated VSG 221 safety glass frosted or black plain on both sides
- possibility to change the glazing side to REVERSE (standard glazing for OBVERSE)

AVAILABLE SOLUTIONS (p. 150-161)

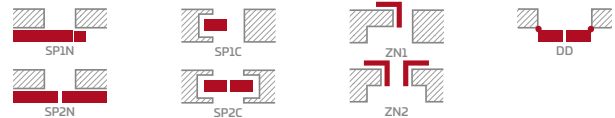

AVAILABLE DOOR LEAF WIDTHS

60 70 80N ⁵⁾ 80 90 100

EXTRA CHARGES

factory pre-drilled through holes for handles (split handles) ordered together with the door leaf

door undercut (p. 145) or air gap undercut

plastic woodgrain sleeves (4 pcs)

round and square metal sleeves (4 pcs); brushed nickel or patina finish in white and black

ventilation grille (only for door leaf widths of 80, 90, 100)

"100" rebated and non-rebated door leaf

VSG 221 laminated safety glass, plain on both sides, frosted or black

metal hinge casings in rebated door leaf (colour: brushed nickel, patina, glossy chrome, glossy brass, white and black)

drop down seal ²⁾

can be replaced with a black or golden magnetic lock for non-rebated door leaves

magnetic stop (buffer) ²⁾ (available in six colours p. 145)

glulam stiles ⁴⁾

¹⁾ plain white facing imitating a painted surface

²⁾ a stop will not allow a drop down seal and an door undercut to be used, and vice versa

³⁾ special AntiFinger coating to reduce dirt and fingerprints

⁴⁾ glulam stiles covered with HDF and MDF boards available for WHITE PREMIUM, NATUR OAK PREMIUM, GRAPHITE ASH PREMIUM, GREY MAPLE PREMIUM, OAK ST CPL at extra charge

⁵⁾ only for non-rebated door leaves



KROKUS

REBATED AND NON-REBATED INTERIOR STILE DOORS



KROKUS 1, BLACK ST CPL facing layer, handle: CUBE PREMIUM, brushed matt chrome



KROKUS 1



KROKUS 2



KROKUS 3



KROKUS 4



KROKUS 5



KROKUS 6

KROKUS 4 in BLACK ST CPL facing layer with CUBE PREMIUM handle, brushed matt chrome



CONSTRUCTION

- rebated or non-rebated door leaf made in the STILE panelled technology
- MDF stiles and rails covered with the GREKO, PREMIUM, ST CPL facings or ST CPL laminate with the AntiFinger coating
- glulam laminated stiles covered with HDF and MDF boards⁴⁾
- 4 mm thick HDF panels with GREKO, CPL or PREMIUM finish
- brushed aluminium insert profiles
- optional door frame extension panels and a crosshead with pilasters are available for an additional charge, p. 147-149
- the door can be trimmed by a customer; go to p. 145 for details

HARDWARE

- rebated door leaves: three silver 2-pin hinges adjusted horizontally
- three concealed hinges in a non-rebated leaf, silver (optionally black - subject to an additional charge); hinges supplied with and included in the price of the door frame
- lever tumbler lock in a rebated door leaf and a key-locked magnetic lock (lever tumbler lock as an option) in a non-rebated door leaf, thumb turn cylinder, economy, with a silver blockade; optionally, for an additional charge, a black or gold magnetic lock

GLAZING

- tempered 4 mm glass, frosted or clear as a standard and, for an additional charge, laminated VSG 221 safety glass frosted or black plain on both sides
- possibility to change the glazing side to REVERSE (standard glazing for OBVERSE)

GREKO

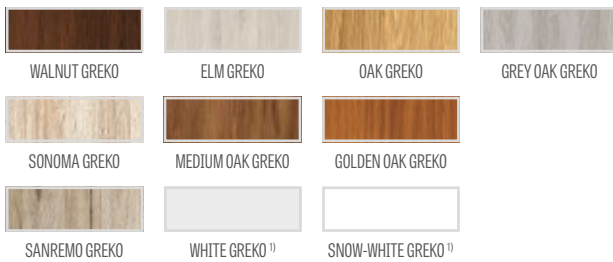

PREMIUM

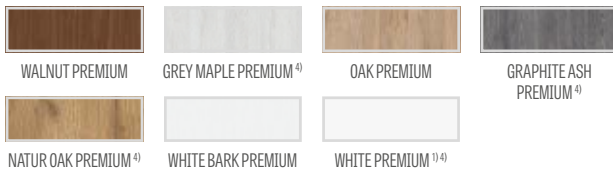

CPL

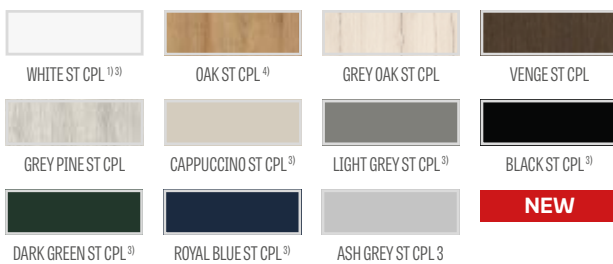

glulam stiles⁴⁾

AVAILABLE SOLUTIONS (p. 150-161)

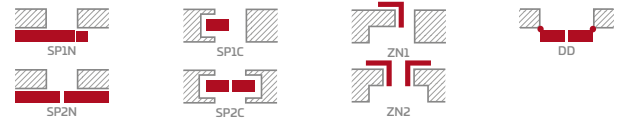

AVAILABLE DOOR LEAF WIDTHS



EXTRA CHARGES

factory pre-drilled through holes for handles (split handles) ordered together with the door leaf

door undercut (p. 145) or air gap undercut

plastic woodgrain sleeves (4 pcs)

round and square metal sleeves (4 pcs); brushed nickel or patina finish in white and black

ventilation grille (only for door leaf widths of 80, 90, 100)

"100" rebated and non-rebated door leaf

VSG 221 laminated safety glass, plain on both sides, frosted or black

metal hinge casings in rebated door leaf (colour: brushed nickel, patina, glossy chrome, glossy brass, white and black)

drop down seal²⁾

can be replaced with a black or golden magnetic lock for non-rebated door leaves

magnetic stop (buffer)²⁾ (available in six colours p. 145)

glulam stiles⁴⁾

¹⁾ plain white facing imitating a painted surface

²⁾ a stop will not allow a drop down seal and an door undercut to be used, and vice versa

³⁾ special AntiFinger coating to reduce dirt and fingerprints

⁴⁾ glulam stiles covered with HDF and MDF boards available for WHITE PREMIUM, NATUR OAK PREMIUM, GRAPHITE ASH PREMIUM, GREY MAPLE PREMIUM, OAK ST CPL at extra charge

⁵⁾ only for non-rebated door leaves



KAMELIA

REBATED AND NON-REBATED INTERIOR STILE DOORS



KAMELIA 1, GRAPHITE ASH PREMIUM facing layer, handle: CUBE, brushed matt chrome



KAMELIA 1



KAMELIA 2



KAMELIA 3



KAMELIA 4



KAMELIA 5



KAMELIA 6



KAMELIA 7



KAMELIA 8

KAMELIA 1 in GRAPHITE ASH PREMIUM facing layer; with CUBE handle, brushed matt chrome



GREKO

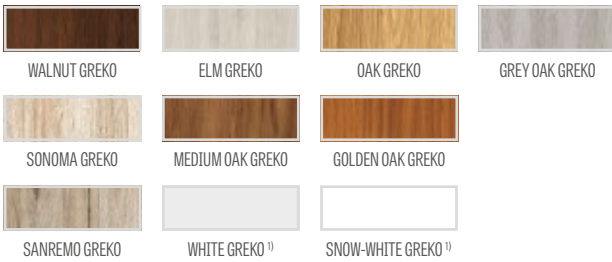

PREMIUM

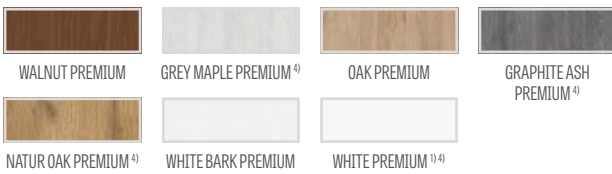

CPL

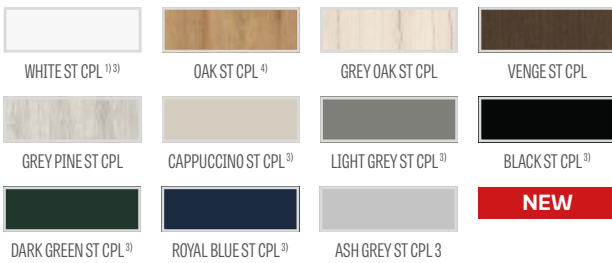

glulam stiles 4)

CONSTRUCTION

- rebated or non-rebated door leaf made in the STILE panelled technology
- MDF stiles and rails covered with the GREKO, PREMIUM, ST CPL facings or ST CPL laminate with the AntiFinger coating
- glulam laminated stiles covered with HDF and MDF boards 4)
- 4 mm thick HDF panels with GREKO, CPL or PREMIUM finish
- optional door frame extension panels and a crosshead with pilasters are available for an additional charge, p. 147-149
- the door can be trimmed by a customer, go to p. 145 for details

HARDWARE

- rebated door leaves: three silver 2-pin hinges adjusted horizontally
- three concealed hinges in a non-rebated leaf, silver (optionally black - subject to an additional charge); hinges supplied with and included in the price of the door frame
- lever tumbler lock in a rebated door leaf and a key-locked magnetic lock (lever tumbler lock as an option) in a non-rebated door leaf, thumb turn cylinder, economy, with a silver blockade; optionally, for an additional charge, a black or gold magnetic lock

GLAZING

- tempered 4 mm glass, frosted or clear as a standard and, for an additional charge, laminated VSG 221 safety glass frosted or black plain on both sides
- possibility to change the glazing side to REVERSE (standard glazing for OBVERSE)

AVAILABLE SOLUTIONS (p. 150-161)

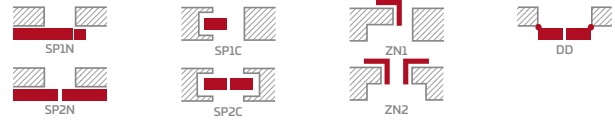

AVAILABLE DOOR LEAF WIDTHS

60 70 80N 5) 80 90 100

EXTRA CHARGES

factory pre-drilled through holes for handles (split handles) ordered together with the door leaf

door undercut (p. 145) or air gap undercut

plastic woodgrain sleeves (4 pcs)

round and square metal sleeves (4 pcs); brushed nickel or patina finish in white and black

ventilation grille (only for door leaf widths of 80, 90, 100)

"100" rebated and non-rebated door leaf

VSG 221 laminated safety glass, plain on both sides, frosted or black

metal hinge casings in rebated door leaf (colour: brushed nickel, patina, glossy chrome, glossy brass, white and black)

drop down seal 2)

can be replaced with a black or golden magnetic lock for non-rebated door leaves

magnetic stop (buffer) 2) (available in six colours p. 145)

glulam stiles 4)

1) plain white facing imitating a painted surface

2) a stop will not allow a drop down seal and an door undercut to be used, and vice versa

3) special AntiFinger coating to reduce dirt and fingerprints

4) glulam stiles covered with HDF and MDF boards available for WHITE PREMIUM, NATUR OAK PREMIUM, GRAPHITE ASH PREMIUM, GREY MAPLE PREMIUM, OAK ST CPL at extra charge

5) only for non-rebated door leaves



PETUNIA

REBATED AND NON-REBATED INTERIOR STILE DOORS



PETUNIA 1, OAK PREMIUM facing layer, handle: TOPAZ, stainless steel



PETUNIA 1



PETUNIA 2



PETUNIA 3

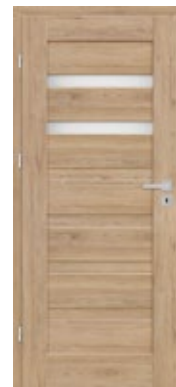

PETUNIA 4



PETUNIA 5



PETUNIA 6



PETUNIA 7

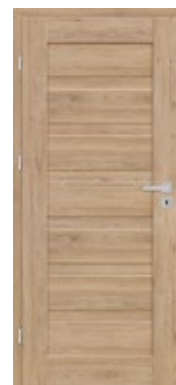

PETUNIA 8

PETUNIA 1 in OAK PREMIUM facing layer and TOPAZ stainless steel handle



GREKO

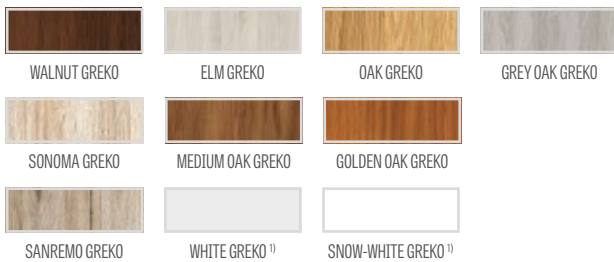

PREMIUM

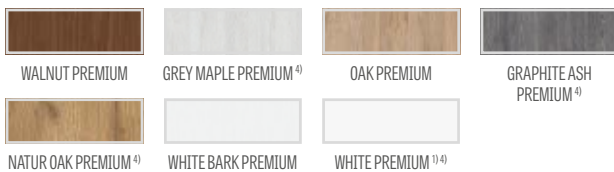

CPL



glulam stiles 4)

CONSTRUCTION

- rebated or non-rebated door leaf made in the STILE panelled technology
- MDF stiles and rails covered with the GREKO, PREMIUM, ST CPL facings or ST CPL laminate with the AntiFinger coating
- glulam laminated stiles covered with HDF and MDF boards 4)
- 4mm thick HDF panels with GREKO, CPL or PREMIUM facing layer
- optional door frame extension panels and a crosshead with pilasters are available for an additional charge, p. 147-149
- the door can be trimmed by a customer, go to p. 145 for details

HARDWARE

- rebated door leaves: three silver 2-pin hinges adjusted horizontally
- three concealed hinges in a non-rebated leaf, silver (optionally black - subject to an additional charge); hinges supplied with and included in the price of the door frame
- lever tumbler lock in a rebated door leaf and a key-locked magnetic lock (lever tumbler lock as an option) in a non-rebated door leaf, thumb turn cylinder, economy, with a silver blockade; optionally, for an additional charge, a black or gold magnetic lock

GLAZING

- tempered 4 mm glass, frosted or clear as a standard and, for an additional charge, laminated VSG 221 safety glass frosted or black plain on both sides
- possibility to change the glazing side to REVERSE (standard glazing for OBVERSE)

AVAILABLE SOLUTIONS (p. 150-161)

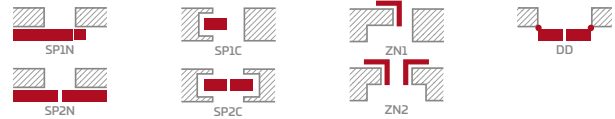

AVAILABLE DOOR LEAF WIDTHS



EXTRA CHARGES

factory pre-drilled through holes for handles (split handles) ordered together with the door leaf

door undercut (p. 145) or air gap undercut

plastic woodgrain sleeves (4 pcs)

round and square metal sleeves (4 pcs); brushed nickel or patina finish in white and black

ventilation grille (only for door leaf widths of 80, 90, 100)

"100" rebated and non-rebated door leaf

VSG 221 laminated safety glass, plain on both sides, frosted or black

metal hinge casings in rebated door leaf (colour: brushed nickel, patina, glossy chrome, glossy brass, white and black)

drop down seal 2)

can be replaced with a black or golden magnetic lock for non-rebated door leaves

magnetic stop (buffer) 2) (available in six colours p. 145)

glulam stiles 4)

1) plain white facing imitating a painted surface

2) a stop will not allow a drop down seal and an door undercut to be used, and vice versa

3) special AntiFinger coating to reduce dirt and fingerprints

4) glulam stiles covered with HDF and MDF boards available for WHITE PREMIUM, NATUR OAK PREMIUM, GRAPHITE ASH PREMIUM, GREY MAPLE PREMIUM, OAK ST CPL at extra charge

5) only for non-rebated door leaves



AZALIA

REBATED AND NON-REBATED INTERIOR STILE DOORS



AZALIA 1, GREY OAK GREKO facing layer, handle: CUBE, black matt



AZALIA 1



AZALIA 2



AZALIA 3



AZALIA 4



AZALIA 5



AZALIA 6



AZALIA 7



AZALIA 8

AZALIA 6 in GREY/OAK GREKO facing layer with CUBE handle, black matt



GREKO

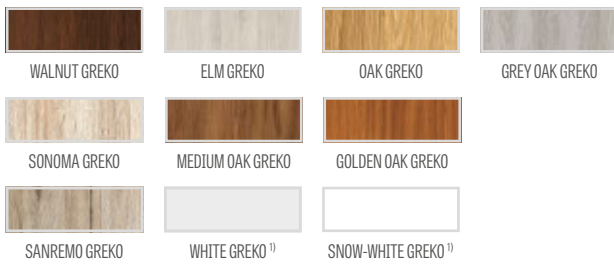

PREMIUM

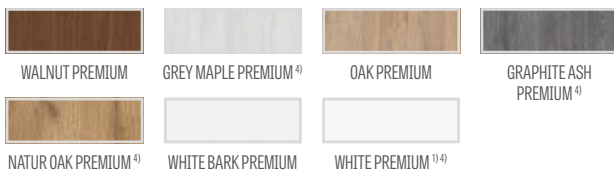

CPL

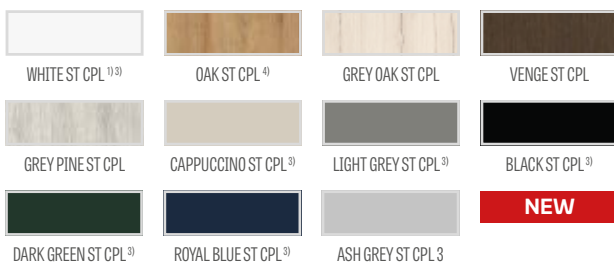

glulam stiles ⁴⁾

CONSTRUCTION

- rebated or non-rebated door leaf made in the STILE panelled technology
- MDF stiles and rails covered with the GREKO, PREMIUM, ST CPL facings or ST CPL laminate with the AntiFinger coating
- glulam laminated stiles covered with HDF and MDF boards ⁴⁾
- 4 mm thick HDF panels with GREKO, CPL or PREMIUM finish
- optional door frame extension panels and a crosshead with pilasters are available for an additional charge, p. 147-149
- the door can be trimmed by a customer, go to p. 145 for details

HARDWARE

- rebated door leaves: three silver 2-pin hinges adjusted horizontally
- three concealed hinges in a non-rebated leaf, silver (optionally black - subject to an additional charge); hinges supplied with and included in the price of the door frame
- lever tumbler lock in a rebated door leaf and a key-locked magnetic lock (lever tumbler lock as an option) in a non-rebated door leaf, thumb turn cylinder, economy, with a silver blockade; optionally, for an additional charge, a black or gold magnetic lock

GLAZING

- tempered 4 mm glass, frosted or clear as a standard and, for an additional charge, laminated VSG 221 safety glass frosted or black plain on both sides
- possibility to change the glazing side to REVERSE (standard glazing for OBVERSE)

AVAILABLE SOLUTIONS (p. 150-161)

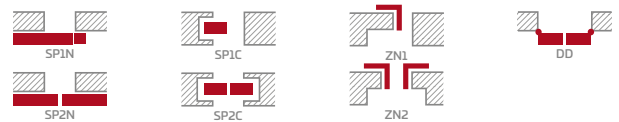

AVAILABLE DOOR LEAF WIDTHS



EXTRA CHARGES

factory pre-drilled through holes for handles (split handles) ordered together with the door leaf

door undercut (p. 145) or air gap undercut

plastic woodgrain sleeves (4 pcs)

round and square metal sleeves (4 pcs); brushed nickel or patina finish in white and black

ventilation grille (only for door leaf widths of 80, 90, 100)

"100" rebated and non-rebated door leaf

VSG 221 laminated safety glass, plain on both sides, frosted or black

metal hinge casings in rebated door leaf
(colour: brushed nickel, patina, glossy chrome, glossy brass, white and black)

drop down seal ²⁾

can be replaced with a black or golden magnetic lock for non-rebated door leaves

magnetic stop (buffer) ²⁾
(available in six colours p. 145)

glulam stiles ⁴⁾

¹⁾ plain white facing imitating a painted surface

²⁾ a stop will not allow a drop down seal and an door undercut to be used, and vice versa

³⁾ special AntiFinger coating to reduce dirt and fingerprints

⁴⁾ glulam stiles covered with HDF and MDF boards available for WHITE PREMIUM, NATUR OAK PREMIUM, GRAPHITE ASH PREMIUM, GREY MAPLE PREMIUM, OAK ST CPL at extra charge

⁵⁾ only for non-rebated door leaves



HIACYNT

REBATED AND NON-REBATED INTERIOR STILE DOORS



HIACYNT 6, ROYAL BLUE ST CPL facing layer, handle: CUBE PREMIUM, brushed matt chrome



HIACYNT 1



HIACYNT 2



HIACYNT 3



HIACYNT 4



HIACYNT 5



HIACYNT 6



HIACYNT 7



HIACYNT 8

HIACYNT 1 in ROYAL BLUE ST CPL facing layer with QUANTA FT handle, black matt



GREKO

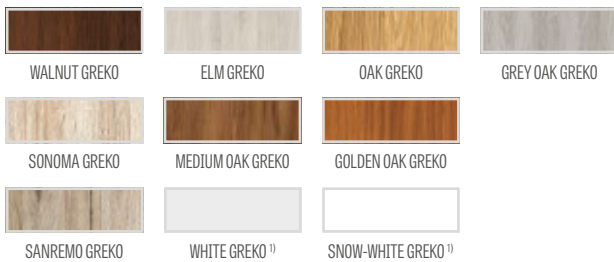

PREMIUM

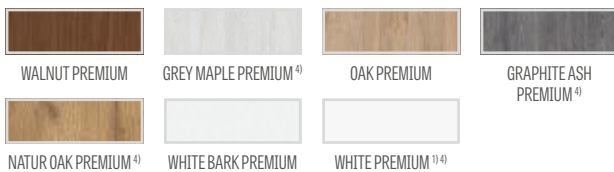

CPL



glulam stiles⁴⁾

CONSTRUCTION

- rebated or non-rebated door leaf made in the STILE panelled technology
- MDF stiles and rails covered with the GREKO, PREMIUM, ST CPL facings or ST CPL laminate with the AntiFinger coating
- glulam laminated stiles covered with HDF and MDF boards⁴⁾
- 22 mm thick HDF panels with GREKO, CPL or PREMIUM finish
- optional door frame extension panels and a crosshead with pilasters are available for an additional charge, p. 147-149
- the door can be trimmed by a customer, go to p. 145 for details

HARDWARE

- rebated door leaves: three silver 2-pin hinges adjusted horizontally
- three concealed hinges in a non-rebated leaf, silver (optionally black - subject to an additional charge); hinges supplied with and included in the price of the door frame
- lever tumbler lock in a rebated door leaf and a key-locked magnetic lock (lever tumbler lock as an option) in a non-rebated door leaf, thumb turn cylinder, economy, with a silver blockade; optionally, for an additional charge, a black or gold magnetic lock

GLAZING

- tempered 4 mm glass, frosted or clear as a standard and, for an additional charge, laminated VSG 221 safety glass frosted or black plain on both sides
- possibility to change the glazing side to REVERSE (standard glazing for OBVERSE)

AVAILABLE SOLUTIONS (p. 150-161)

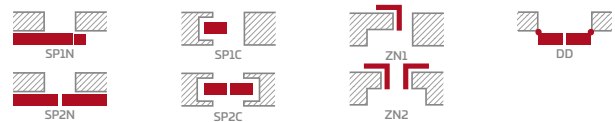

AVAILABLE DOOR LEAF WIDTHS



EXTRA CHARGES

factory pre-drilled through holes for handles (split handles) ordered together with the door leaf

door undercut (p. 145) or air gap undercut

plastic woodgrain sleeves (4 pcs)

round and square metal sleeves (4 pcs); brushed nickel or patina finish in white and black

ventilation grille (only for door leaf widths of 80, 90, 100)

"100" rebated and non-rebated door leaf

VSG 221 laminated safety glass, plain on both sides, frosted or black

metal hinge casings in the rebated door leaf (brushed nickel, patina, polished chrome, polished brass, white and black)

drop down seal²⁾

can be replaced with a black or golden magnetic lock for non-rebated door leaves

magnetic stop (buffer)²⁾
(available in six colours p. 145)

glulam stiles⁴⁾

¹⁾ plain white facing imitating a painted surface

²⁾ a stop will not allow a drop down seal and an door undercut to be used, and vice versa

³⁾ special AntiFinger coating to reduce dirt and fingerprints

⁴⁾ glulam stiles covered with HDF and MDF boards available for WHITE PREMIUM, NATUR OAK PREMIUM, GRAPHITE ASH PREMIUM, GREY MAPLE PREMIUM, OAK ST CPL at extra charge

⁵⁾ only for non-rebated door leaves



FRAGI

REBATED INTERIOR STILE DOORS



FRAGI 5, BLACK ST CPL facing layer, handle: CUBE PREMIUM, brushed matt chrome



FRAGI 1



FRAGI 4
DECORMAT

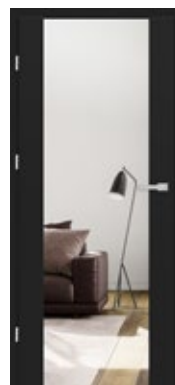

FRAGI 5
CLEAR



FRAGI 7
DECORMAT GRAFIT



FRAGI 9



FRAGI 10



FRAGI 15
Frosted VSG/ESG



FRAGI 16
Black VSG/ESG

FRAGI 4 in BLACK ST CPL facing layer with CUBE PREMIUM handle, brushed matt chrome

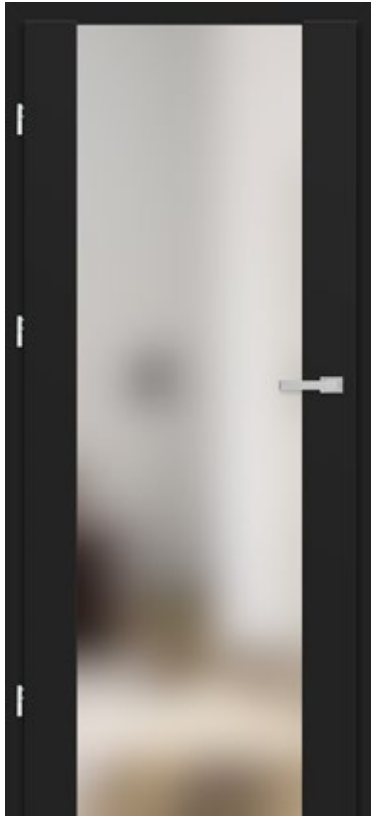

CONSTRUCTION

- rebated door leaf made in STILE panelled technology
- MDF stiles and rails covered with the GREKO, PREMIUM, ST CPL facings or ST CPL laminate with the AntiFinger coating
- glulam laminated stiles covered with HDF and MDF boards³⁾
- optional door frame extension panels and a crosshead with pilasters are available for an additional charge, p. 147-149

HARDWARE

- rebated door leaves: three silver 2-pin hinges adjusted horizontally
- a lever tumbler lock, euro profile cylinder, economy lock or with a thumb turn

GLAZING

- 8 mm tempered or tempered and VSG/ESG 441 laminated safety glass, frosted or black, plain on both sides (in Fragi 15 & Fragi 16)
- possibility to change the glazing side to REVERSE (standard glazing for OBTVERSE)

AVAILABLE SOLUTIONS (p. 159-161)



AVAILABLE DOOR LEAF WIDTHS

60 70 80 90

EXTRA CHARGES

factory pre-drilled through holes for handles (split handles) ordered together with the door leaf

air gap undercut

metal hinge casings in rebated door leaf
(colour: brushed nickel, patina, glossy chrome, glossy brass, white and black)

magnetic stop (buffer) (available in six colours p. 145)

glulam stiles³⁾

Note:

The picture shows only an 80cm-wide door leaf. The proportion in the picture differ slightly for the other FRAGI 1 model widths. For further details and photos go to our website: www.erkado.pl

STANDARD "OBTVERSE" GLAZING

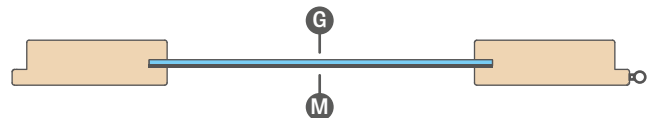

"REVERSE" GLAZING MADE TO ORDER

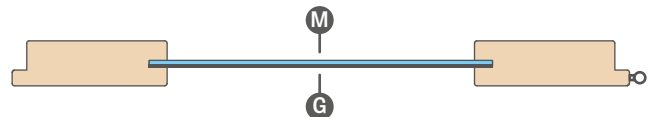

G Plain side; **M** ornamented matt side;

GREKO

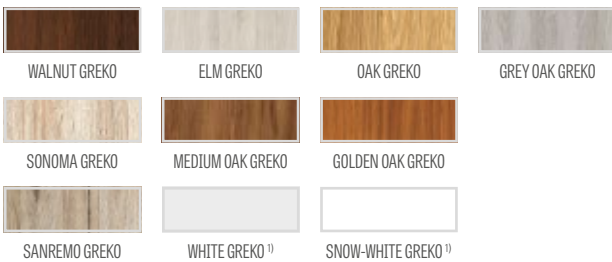

PREMIUM

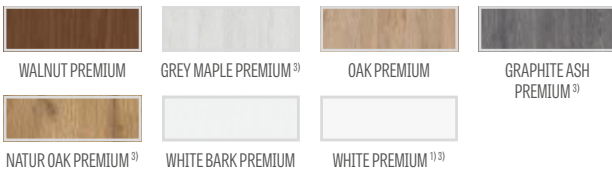

CPL

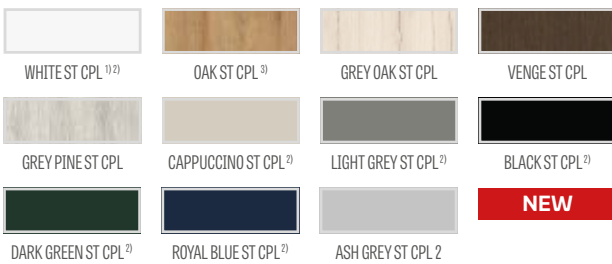

glulam stiles³⁾

¹⁾ plain white facing imitating a painted surface

²⁾ special AntiFinger coating to reduce dirt and fingerprints

³⁾ glulam stiles covered with HDF and MDF boards available for WHITE PREMIUM, NATUR OAK PREMIUM, GRAPHITE ASH PREMIUM, GREY MAPLE PREMIUM, OAK ST CPL at extra charge



GRAF GLASS DOORS

INTERIOR GLASS DOORS



GRAF 8 DECORMAT



GRAF 9 CLEAR



GRAF 11 DECORMAT GRAPHITE

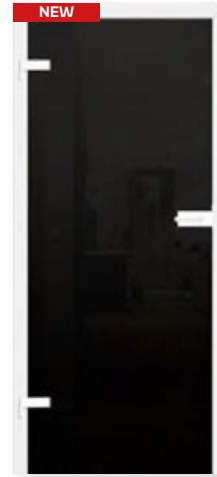

GRAF 65 VSG/ESG, black opaque



GRAF 32

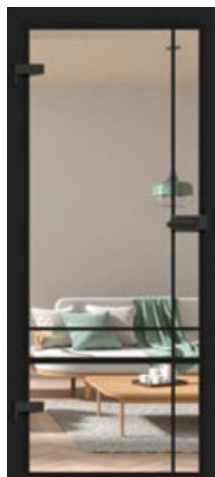

GRAF 33



GRAF 35

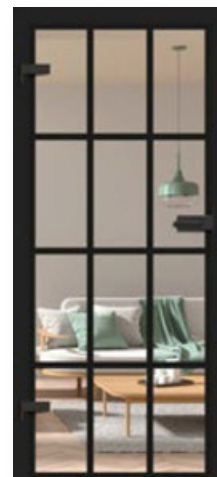

GRAF 36

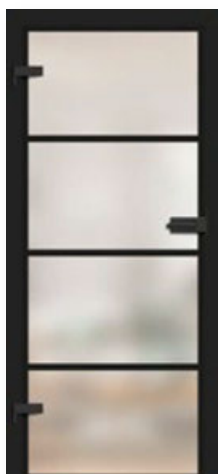

GRAF 38

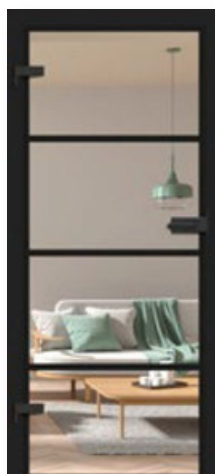

GRAF 39

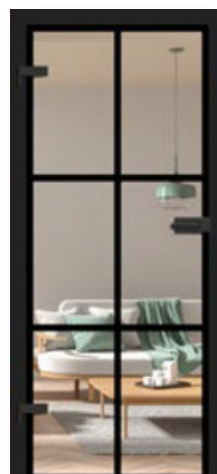

GRAF 61



GRAF 62

GLAZING TRANSLUCENCY REFERENCE PHOTOS in p. 146

GRAF 368 mm tempered glass with black decorative pattern, door frame in BLACK ST CPL facing



CONSTRUCTION

- 8 mm tempered glass with or without external decorative patterns, 8 mm tinted glass (GRAF 26) or, for an extra charge, laminated and tempered VSG/ESG glass with black internal decorative patterns for GRAF 32, 33, 35, 36, 38, 39, 61, 62
- possibility to change the glazing side to REVERSE (standard glazing for OBVERSE)
- frosted or plain glass with black or white painted patterns, depending on the model design
- the line width (thickness) of the GRAF 35, 36, 38, 39, 61, 62 models is 30 mm
- optional door frame extension panels and a crosshead with pilasters are available for an additional charge, p. 147-149
- available model GRAF 66, VSG/ESG frosted glass **NEW**

FIXED AND ADJUSTABLE FRAMES

- for prices of fixed and adjustable frames for rebated doors go to p. 176-179
- no electric strike possible
- 10 mm pin hinge for glass panes frames
- in the fixed and adjustable frame, it is possible to change the black or white powder-coated strike plate (at an extra charge)
- **ONLY REBATED FRAMES IN ALL AVAILABLE FACINGS, STEEL FRAMES AND THE WHITE PAINTED TITANIUM UV FRAME ARE AVAILABLE FOR GLASS GRAF DOORS**

NOTE: for the extended Glass Door Collection and a variety of available models go to our website: www.erkado.pl. You can also order the available models through the B2B panel.

AVAILABLE DOOR LEAF WIDTHS

60 70 80 90 (charged extra)



See more at www.erkado.pl

EXTRA CHARGES

VSG/ESG glass with internal black decorative pattern²⁾
(GRAF 32, 33, 35, 36, 38, 39, 61, 62)

"90" door leaf

air gap undercut

black or white strike plate

HARDWARE METAL-BUD stainless steel, black, white (available shapes: oval or rectangular)

Metal-Bud



¹⁾ For the details of how to select bathroom fittings (locking with thumbturn) go to p. 144; ²⁾ VSG/ESG glass has two glued glass panes visible at the edge



LAMELLAS

WALL-MOUNTED



Wall lamellas: decorative strip OAK ST CPL, adapter BLACK ST CPL, skirting board OAK ST CPL, door BALDUR 3 OAK ST CPL, black VSG glass

Decorative lamellas are mounted on the wall as a decorative element and at the same time improve the acoustics in the room.

Mounting is possible in several ways - the decorative skirting board can be mounted to the wall by means of a mounting strip only or with the use of adapters which constitute a base for the panels.

Decorative lamellas are available with PREMIUM and ST CPL facings and can be joined in selected combinations.



components of wall lamellas



composition of decorative lamellas with the skirting board OAK ST CPL

DECORATIVE STRIP

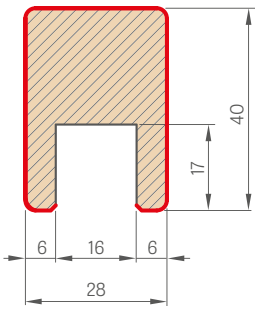

MOUNTING STRIP

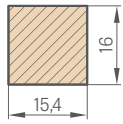

END STRIP

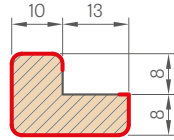

ADAPTER

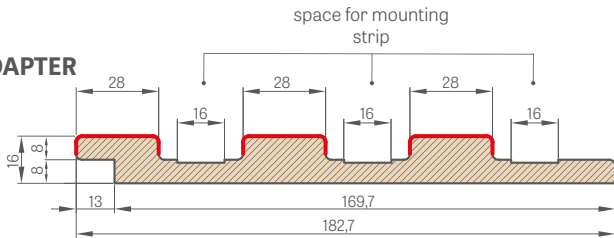

— FACING LAYER

DECORATIVE LAMELLA

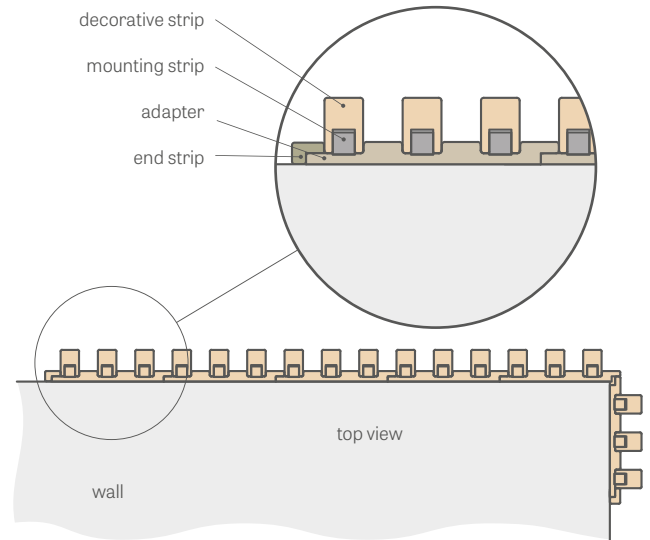

Installation video
variant with an adapter:
<https://youtu.be/p317u3cWMmg>



Installation video
no adapter variant:
<https://youtu.be/jFa5afWWFOM>



The individual components of the decorative lamella system are commercially available in a length of 2750 mm, however each product has a production length of 2800 mm and is delivered in this length, where 25 mm per side is a margin for free trimming before installation and also a reserve in case of transport damage.

The wall lamellas can also be mounted without an adapter directly to the wall using only a mounting strip on which we mount the decorative strip.

Decorative strip (with the mounting strip included) can be purchased only in multiple of 3 pieces, e.g. 3 pcs, 6 pcs, 9 pcs, etc.

The blanking straps are available across the range of facings and are used to conceal the cut of the decorative strip. The blanking straps have a self-adhesive surface on one side.

adapter - quantity in pack 1 piece
end strip - package quantity 1 piece
decorative strip + mounting strip - pack of 3 pcs + 3 pcs

PREMIUM

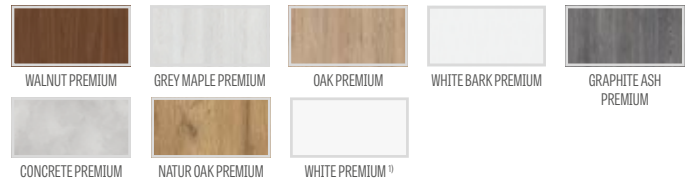

CPL

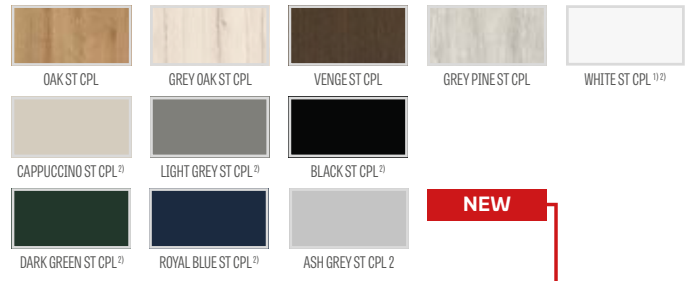

SKIRTING BOARDS

SKIRTING BOARD

- length: 2.40 running metres.
- The skirting board is made of moisture resistant MDF board. Available variants: WHITE TITANIUM UV paint; facings: GREKO, ST CPL, PREMIUM and in a base facing to be paint coated.
- Fitting method: bonding to wall

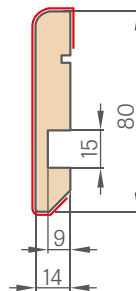

1) plain white facing imitating a painted surface
2) special AntiFinger coating to reduce dirt and fingerprints



AMARYLIS

REBATED, NON-REBATED PAINTED DOORS



AMARYLIS 6 with CUBE PREMIUM handle, black matt



AMARYLIS 1



AMARYLIS 2

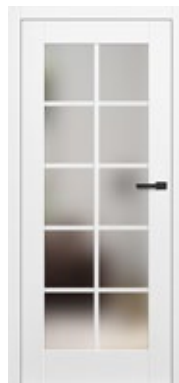

AMARYLIS 3



AMARYLIS 4



AMARYLIS 5



AMARYLIS 6



AMARYLIS 7



AMARYLIS 8



AMARYLIS 9



NEW

stick-on glazing bar on both sides, 25 mm wide

AMARYLIS 6 with CUBE PREMIUM handle, black matt

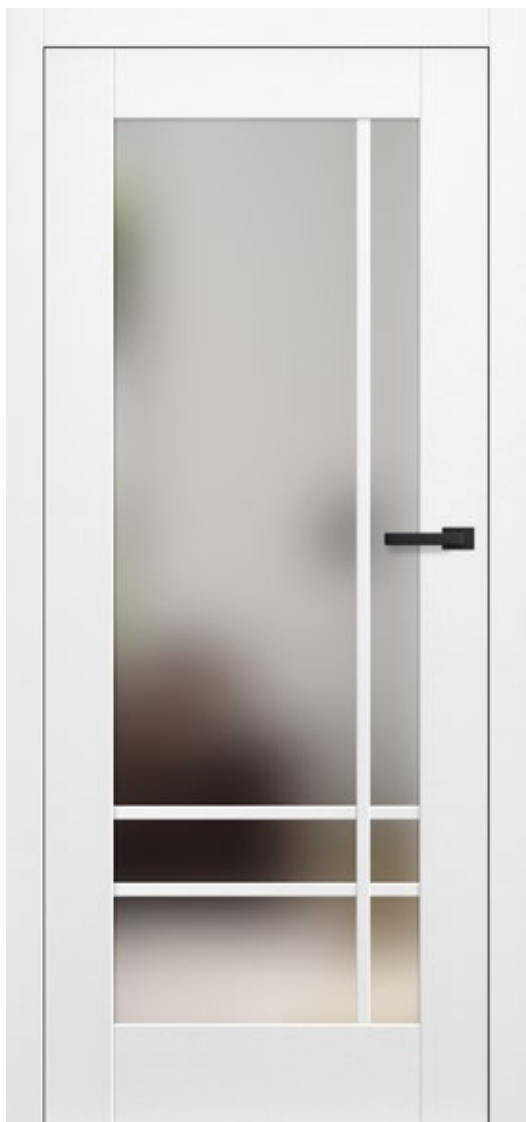

PAINTED

WHITE TITANIUM UV

AVAILABLE SOLUTIONS (p. 150-161)

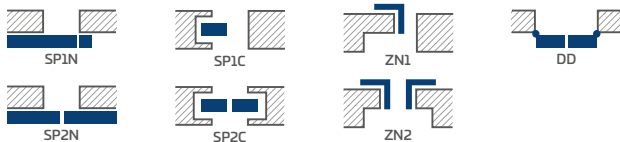

AVAILABLE DOOR LEAF WIDTHS

60 70 80N²⁾ 80 90 100

CONSTRUCTION

- rebated or non-rebated door leaf made in the STILE panelled technology
- MDF stiles and rails coated with a facing layer and painted with UV-resistant varnish
- 16 mm thick HDF panels, moulded and coated with UV resistant varnish
- stick-on glazing bar on both sides, 25 mm wide, heights of 12 mm (vertical) and 8 mm (horizontal)
- optional door frame extension panels and a crosshead with pilasters are available for an additional charge, p. 147-149
- the door can be trimmed by a customer, go to p. 145 for details

FINISHING

- door leaves and door frames coated with water-based UV hardened varnish for high resistance to adverse use conditions

HARDWARE

- rebated door leaves: three silver 2-pin hinges adjusted horizontally
- three concealed hinges in a non-rebated leaf, silver (optionally black - subject to an additional charge); hinges supplied with and included in the price of the door frame
- lever tumbler lock in a rebated door leaf and a key-locked magnetic lock (lever tumbler lock as an option) in a non-rebated door leaf, thumb turn cylinder, economy, with a silver blockade; optionally, for an additional charge, a black or gold magnetic lock

GLAZING

- frosted or clear tempered glass as standard, and frosted or black VSG 221 laminated safety glass at an extra charge, plain on both sides
- possibility to change the glazing side to REVERSE (standard glazing for OBVERSE)

EXTRA CHARGES

factory pre-drilled through holes for handles (split handles) ordered together with the door leaf

door undercut (p. 145) or air gap undercut

"100" rebated and non-rebated door leaf

metal hinge casings in the rebated door leaf (brushed nickel, patina, polished chrome, polished brass, white and black)

VSG 221 laminated safety glass, plain on both sides, frosted or black

drop down seal¹⁾

can be replaced with a black or golden magnetic lock for non-rebated door leaves

magnetic stop (buffer)¹⁾
(available in six colours p. 145)

¹⁾ a stop will not allow a drop down seal and an door undercut to be used, and vice versa

²⁾ only for non-rebated door leaves



PEONIA

REBATED, NON-REBATED PAINTED DOORS

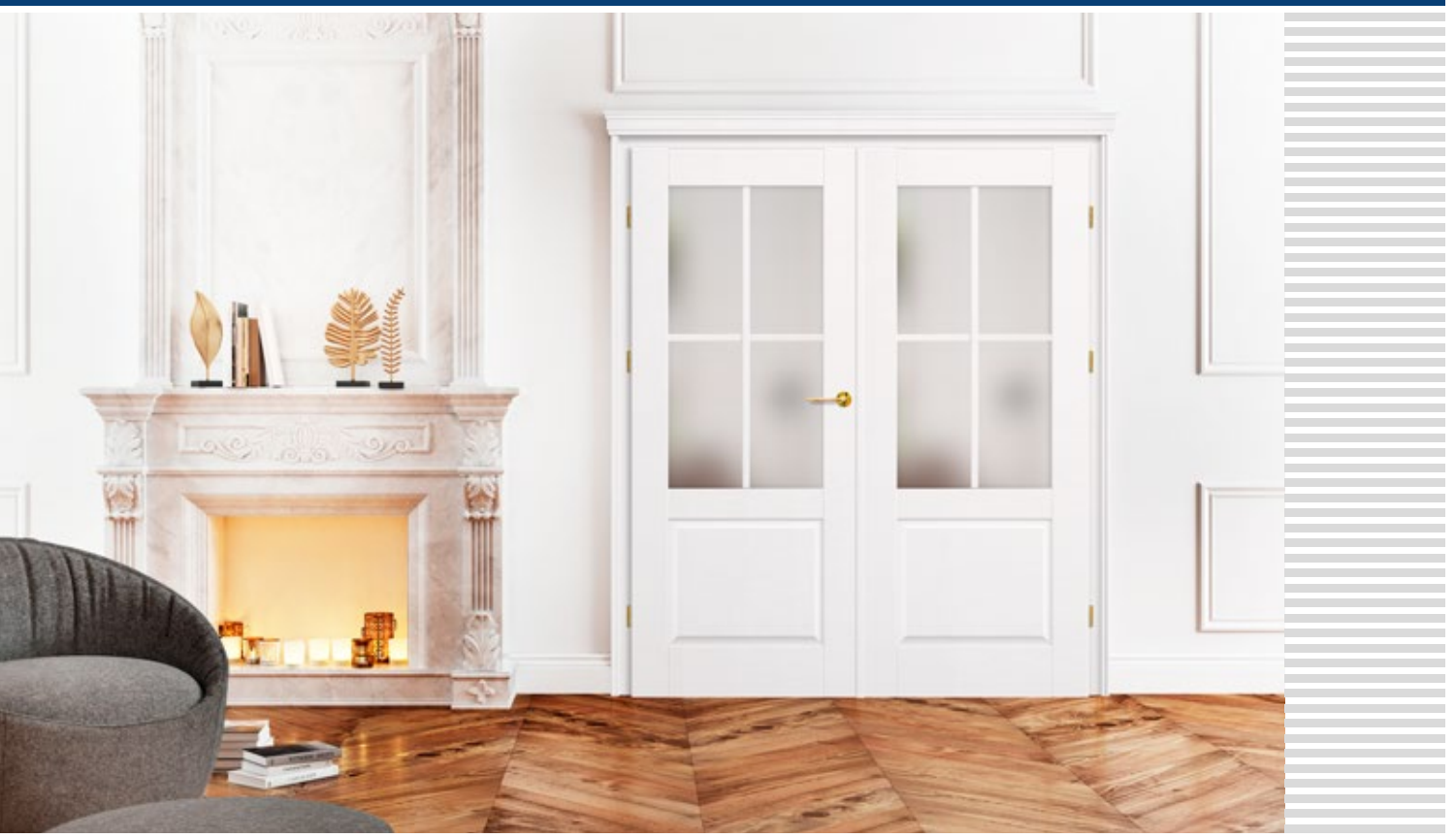

PEONIA 1 with BELLA SLIM handle, shiny brass, decorative crosshead³⁾



PEONIA 1



PEONIA 2



PEONIA 3



NEW

stick-on glazing bar on both sides, 25 mm wide



PEONIA 4



PEONIA 5



PEONIA 6

PEONIA 2 with CUBE handle, black matt, decorative crosshead³⁾

PAINTED

WHITE TITANIUM UV

AVAILABLE SOLUTIONS (p. 150-161)

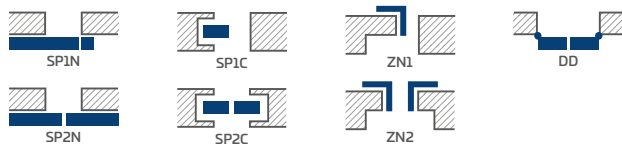

AVAILABLE DOOR LEAF WIDTHS

60 70 80N²⁾ 80 90 100

CONSTRUCTION

- rebated or non-rebated door leaf made in the STILE panelled technology
- MDF stiles and rails coated with a facing layer and painted with UV-resistant varnish
- 16 mm thick HDF panels, moulded and coated with UV resistant varnish
- stick-on glazing bar on both sides, 25 mm wide, heights of 12 mm (vertical) and 8 mm (horizontal)
- optional door frame extension panels and a crosshead with pilasters are available for an additional charge, p. 147-149
- the door can be trimmed by a customer, go to p. 145 for details

FINISHING

- door leaves and door frames coated with water-based UV hardened varnish for high resistance to adverse use conditions

HARDWARE

- rebated door leaves: three silver 2-pin hinges adjusted horizontally
- three concealed hinges in a non-rebated leaf, silver (optionally black - subject to an additional charge); hinges supplied with and included in the price of the door frame
- lever tumbler lock in a rebated door leaf and a key-locked magnetic lock (lever tumbler lock as an option) in a non-rebated door leaf, thumb turn cylinder, economy, with a silver blockade; optionally, for an additional charge, a black or gold magnetic lock

GLAZING

- frosted or clear tempered glass as standard, and frosted or black VSG 221 laminated safety glass at an extra charge, plain on both sides
- possibility to change the glazing side to REVERSE (standard glazing for OBVERSE)

EXTRA CHARGES

factory pre-drilled through holes for handles (split handles) ordered together with the door leaf

Door undercut (p. 145) or air gap undercut

"100" rebated and non-rebated door leaf

metal hinge casings in the rebated door leaf (brushed nickel, patina, polished chrome, polished brass, white and black)

VSG 221 laminated safety glass, plain on both sides, frosted or black

drop down seal¹⁾

can be replaced with a black or golden magnetic lock for non-rebated door leaves

magnetic stop (buffer)¹⁾
(available in six colours p. 145)

¹⁾ a stop will not allow a drop down seal and an door undercut to be used, and vice versa

²⁾ only for non-rebated door leaves

³⁾ decorative crosshead with pilasters for an additional charge, p. 147



MISKANT

REBATED, NON-REBATED PAINTED DOORS



MISKANT 2, BELLA SLIM handle, black matt



MISKANT 1

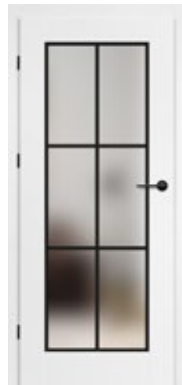

MISKANT 2

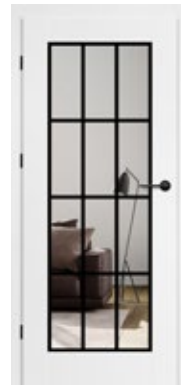

MISKANT 3



NEW

Black lines with a width of 18 mm, screen painted

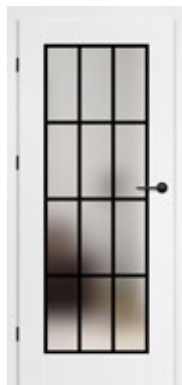

MISKANT 4

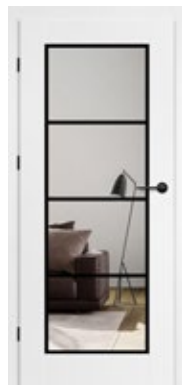

MISKANT 5



MISKANT 6

MISKANT 4 with BELLA SLIM handle, black matt



CONSTRUCTION

- rebated or non-rebated door leaf made in the STILE panelled technology
- MDF stiles and rails coated with a facing layer and painted with UV-resistant varnish
- optional door frame extension panels and a crosshead with pilasters are available for an additional charge, p. 147-149
- the door can be trimmed by a customer; go to p. 145 for details

FINISHING

- door leaves and door frames coated with water-based UV hardened varnish for high resistance to adverse use conditions

HARDWARE

- rebated door leaves: three silver 2-pin hinges adjusted horizontally
- three concealed hinges in a non-rebated leaf, silver (optionally black - subject to an additional charge); hinges supplied with and included in the price of the door frame
- lever tumbler lock in a rebated door leaf and a key-locked magnetic lock (lever tumbler lock as an option) in a non-rebated door leaf, thumb turn cylinder, economy, with a silver blockade; optionally, for an additional charge, a black or gold magnetic lock

GLAZING

- tempered frosted or clear glass with a thickness of 4 mm or, for an extra charge, VSG laminated glass with internal decorative pattern
- possibility to change the glazing side to REVERSE (standard glazing for OBVERSE)
- black screen printed lines on one side of glass with a width (thickness) of 18 mm

STANDARD "OBVERSE" GLAZING



"REVERSE" GLAZING MADE TO ORDER

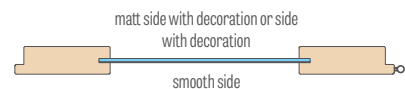

PAINTED

WHITE TITANIUM UV

EXTRA CHARGES

factory pre-drilled through holes for handles (split handles) ordered together with the door leaf

VSG laminated glass with internal decorative pattern in black or white

door undercut (p. 145) or air gap undercut

"100" rebated and non-rebated door leaf

metal hinge casings in the rebated door leaf (brushed nickel, patina, polished chrome, polished brass, white and black)

drop down seal¹⁾

can be replaced with a black or golden magnetic lock for non-rebated door leaves

magnetic stop (buffer)¹⁾
(available in six colours p. 145)

AVAILABLE SOLUTIONS (p. 150-161)

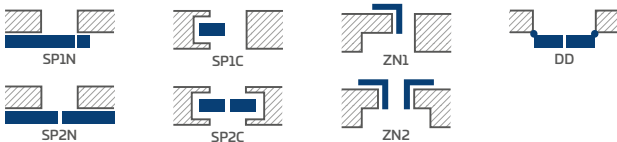

AVAILABLE DOOR LEAF WIDTHS

60 70 80N²⁾ 80 90 100

¹⁾ a stop will not allow a drop down seal and an door undercut to be used, and vice versa

²⁾ only for non-rebated door leaves



NEMEZJA

REBATED, NON-REBATED PAINTED DOORS



NEMEZJA 8, BELLA SLIM handle, round, glossy brass



NEMEZJA 1



NEMEZJA 4



NEMEZJA 7



NEMEZJA 8



NEMEZJA 9



NEMEZJA 10



NEMEZJA 11



NEMEZJA 12



NEMEZJA 13



NEMEZJA 14

NEMEZJA 6 with BELLA SLIM handle, round, glossy brass



CONSTRUCTION

- rebated or non-rebated door leaf made in the STILE panelled technology
- MDF stiles and rails coated with a facing layer and painted with UV-resistant varnish
- 16 mm thick HDF panels, moulded and coated with UV resistant varnish
- optional door frame extension panels and a crosshead with pilasters are available for an additional charge, p. 147-149
- the door can be trimmed by a customer, go to p. 145 for details

FINISHING

- door leaves and door frames coated with water-based UV hardened varnish for high resistance to adverse use conditions

HARDWARE

- rebated door leaves: three silver 2-pin hinges adjusted horizontally
- three concealed hinges in a non-rebated leaf, silver (optionally black - subject to an additional charge); hinges supplied with and included in the price of the door frame
- lever tumbler lock in a rebated door leaf and a key-locked magnetic lock (lever tumbler lock as an option) in a non-rebated door leaf, thumb turn cylinder, economy, with a silver blockade; optionally, for an additional charge, a black or gold magnetic lock

GLAZING

- frosted or clear tempered glass as standard, and frosted or black VSG 221 laminated safety glass at an extra charge, plain on both sides
- possibility to change the glazing side to REVERSE (standard glazing for OBVERSE)

PAINTED



WHITE TITANIUM UV

AVAILABLE SOLUTIONS (p. 150-161)

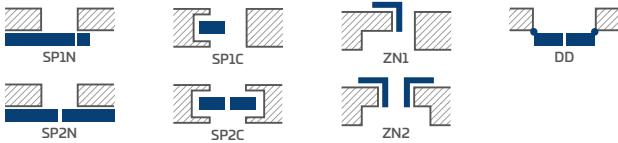

AVAILABLE DOOR LEAF WIDTHS

60 70 80N²⁾ 80 90 100

EXTRA CHARGES

factory pre-drilled through holes for handles (split handles) ordered together with the door leaf

Door undercut (p. 145) or air gap undercut

"100" rebated and non-rebated door leaf

metal hinge casings in the rebated door leaf (brushed nickel, patina, polished chrome, polished brass, white and black)

VSG 221 laminated safety glass, plain on both sides, frosted or black

drop down seal¹⁾

can be replaced with a black or golden magnetic lock for non-rebated door leaves

magnetic stop (buffer)¹⁾
(available in six colours p. 145)

¹⁾ a stop will not allow a drop down seal and an door undercut to be used, and vice versa

²⁾ only for non-rebated door leaves



LAURENCJA

REBATED, NON-REBATED PAINTED DOORS



LAURENCJA 1, black VSG glass, handle: BELLA SLIM, round, black matt



LAURENCJA 1



LAURENCJA 2



LAURENCJA 3



LAURENCJA 4



LAURENCJA 5



LAURENCJA 6

LAURENCIA1 with BELLASLIM handle, round black matt, and VSG 221 laminated glass, black



CONSTRUCTION

- rebated or non-rebated door leaf made in the STILE panelled technology
- MDF stiles and rails coated with a facing layer and painted with UV-resistant varnish
- 4 mm thick HDF panels, moulded and coated with UV-resistant varnish
- optional door frame extension panels and a crosshead with pilasters are available for an additional charge, p. 147-149
- the door can be trimmed by a customer, go to p. 145 for details

FINISHING

- door leaves and door frames coated with water-based UV hardened varnish for high resistance to adverse use conditions

HARDWARE

- rebated door leaves: three silver 2-pin hinges adjusted horizontally
- three concealed hinges in a non-rebated leaf, silver (optionally black - subject to an additional charge); hinges supplied with and included in the price of the door frame
- lever tumbler lock in a rebated door leaf and a key-locked magnetic lock (lever tumbler lock as an option) in a non-rebated door leaf, thumb turn cylinder, economy, with a silver blockade; optionally, for an additional charge, a black or gold magnetic lock

GLAZING

- frosted or clear tempered glass as standard, and frosted or black VSG 221 laminated safety glass at an extra charge, plain on both sides
- possibility to change the glazing side to REVERSE (standard glazing for OBVERSE)

PAINTED



WHITE TITANIUM UV

AVAILABLE SOLUTIONS (p. 150-161)



SP1N



SP1C



ZN1



DD

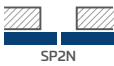

SP2N

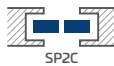

SP2C



ZN2

AVAILABLE DOOR LEAF WIDTHS

60 70 80N²⁾ 80 90 100

EXTRA CHARGES

factory pre-drilled through holes for handles (split handles) ordered together with the door leaf

door undercut (p. 145) or air gap undercut

"100" rebated and non-rebated door leaf

metal hinge casings in the rebated door leaf (brushed nickel, patina, polished chrome, polished brass, white and black)

VSG 221 laminated safety glass, plain on both sides, frosted or black

drop down seal¹⁾

can be replaced with a black or golden magnetic lock for non-rebated door leaves

magnetic stop (buffer)¹⁾
(available in six colours p. 145)

¹⁾ a stop will not allow a drop down seal and an door undercut to be used, and vice versa

²⁾ only for non-rebated door leaves



BALDUR

REBATED, NON-REBATED AND REVERSE PAINTED DOORS



BALDUR 1 with CUBE PREMIUM handle, black matt, and VSG 441 laminated glass, black



BALDUR 1



BALDUR 2



BALDUR 3



BALDUR 4



BALDUR 5



BALDUR 6



BALDUR 7



BALDUR 8

BALDUR7 with CUBE PREMIUM handle, black matt



PAINTED



WHITE TITANIUM UV

AVAILABLE SOLUTIONS ¹⁾³⁾ (p. 150-161)

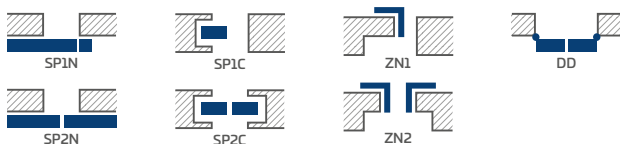

AVAILABLE DOOR LEAF WIDTHS

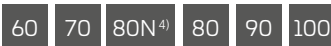

MOULDING

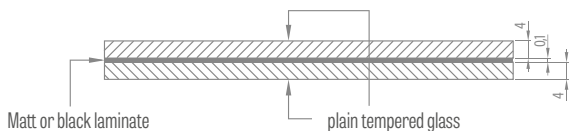
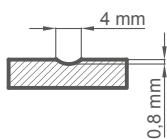

VSG/ESG laminated and tempered glass as a standard, frosted or black

CONSTRUCTION

- rebated, non-rebated or reverse door leaf
- internal timber stiles and top rail, MDF bottom rail, covered with two HDF boards
- rigid honeycomb infill or solid core infill for additional charge
- optional door frame extension panels and a crosshead with pilasters are available for an additional charge, p. 147-149
- the door can be trimmed by a customer, go to p. 145 for details (not for BALDUR1, 3, 5)

FINISHING

- door leaves and door frames coated with water-based UV hardened varnish for high resistance to adverse use conditions
- door leaf edge made in standard or non-rebated technology
- the BALDUR 1 sliding systems have a visible 17 mm high aluminium or black coloured profile in the lower part of the glass pane

HARDWARE

- three pin mortise hinges in a rebated door leaf
- three concealed hinges in the non-adjacent leaf and two hinges in the reverse leaf in silver (black against an extra charge); hinges are supplied and priced with the door frame
- a lever tumbler lock in the rebated door leaf and a key-locked magnetic lock (lever tumbler lock as an option) in the non-rebated and reverse door leaves, thumb turn cylinder, economy or silver with a blockade or, optionally, for an additional charge, a black or golden magnetic lock

GLAZING

- **BALDUR 1, 3, 5: VSG/ESG 441 laminated and tempered safety glass as standard, frosted or black, plain on both sides**
- fixed glazing widths: BALDUR 1 – 50 mm, BALDUR 3, 5 – 210 mm

ADDITIONAL CHARGES

reverse door leaf
solid core filling
door undercut (p. 145) or air gap undercut
"100" rebated and non-rebated door leaf
additional bottom rail for the customer to be able to cut the door by up to 8 cm (not for BALDUR 1, 3, 5)
metal hinge casings in the rebated door leaf (brushed nickel, patina, polished chrome, polished brass, white and black)
drop down seal ²⁾ (not for BALDUR 1, 3, 5)
can be replaced with a black or golden magnetic lock for non-rebated and reverse leaves
magnetic stop (buffer) ²⁾ (available in six colours p. 145)
standard PL2112

AIR GAP UNDERCUT

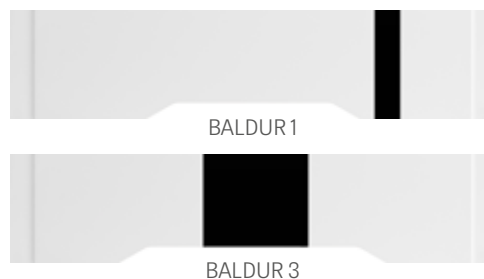

¹⁾ the BALDUR 1, 3, 5 models are not available with sliding systems or double doors
²⁾ a stop will not allow a drop down seal and an door undercut to be used, and vice versa
³⁾ the BALDUR 1 model is not available with pocket systems
⁴⁾ only for non-rebated and reversed swing doors



ANUBIS

REBATED, NON-REBATED AND REVERSE PAINTED DOORS



ANUBIS 2, BELLA SLIM handle, round, glossy brass



ANUBIS 1



ANUBIS 2



ANUBIS 3



ANUBIS 4



ANUBIS 5

ANUBIS 3 with BELLA SLIM handle, round, shiny brass



CONSTRUCTION

- rebated, non-rebated or reverse door leaf
- internal timber stiles and top rail, MDF bottom rail, covered with two HDF boards
- rigid honeycomb infill or solid core infill for additional charge
- optional door frame extension panels and a crosshead with pilasters are available for an additional charge, p. 147-149
- the door can be trimmed by a customer, go to p. 145 for details

FINISHING

- door leaves and door frames coated with water-based UV hardened varnish for high resistance to adverse use conditions
- door leaf edge made in standard or non-rebated technology

HARDWARE

- three pin mortise hinges in a rebated door leaf
- three concealed hinges in the non-adjacent leaf and two hinges in the reverse leaf in silver (black against an extra charge); hinges are supplied and priced with the door frame
- a lever tumbler lock in the rebated door leaf and a key-locked magnetic lock (lever tumbler lock as an option) in the non-rebated and reverse door leaves, thumb turn cylinder, economy or silver with a blockade or, optionally, for an additional charge, a black or golden magnetic lock

MOULDING

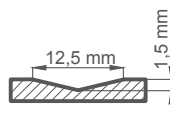

PAINTED



WHITE TITANIUM UV

AVAILABLE SOLUTIONS (p. 150-161)

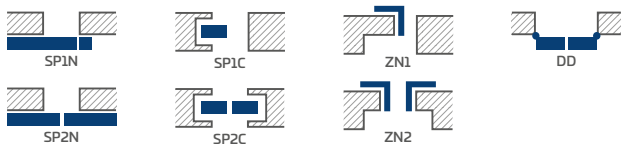

AVAILABLE DOOR LEAF WIDTHS

60 70 80N²⁾ 80 90 100

EXTRA CHARGES

reverse door leaf

solid core filling

door undercut (p. 145) or air gap undercut

"100" rebated and non-rebated door leaf

additional bottom rail (can be trimmed by a customer up to max 8 cm)

metal hinge casings in the rebated door leaf (brushed nickel, patina, polished chrome, polished brass, white and black)

drop down seal¹⁾

can be replaced with a black or golden magnetic lock for non-rebated and reverse leaves

magnetic stop (buffer)¹⁾
(available in six colours p. 145)

standard PL2112

¹⁾ a stop will not allow a drop down seal and an door undercut to be used, and vice versa

²⁾ only for non-rebated and reversed swing doors



UNO PREMIUM

REBATED, NON-REBATED AND REVERSE PAINTED DOORS



UNO PREMIUM, LUNA handle, glossy chrome

Frame side view: non-rebated door, 8 cm architrave, frame joints at 90°



Frame side view: rebated door, 8 cm architrave, frame joints at 45°



Hinge side view: rebated door, 6 cm architrave, frame joints at 45°



UNO PREMIUM with black matt CUBE handle



PAINTED



WHITE TITANIUM UV

AVAILABLE SOLUTIONS (p. 150-161)

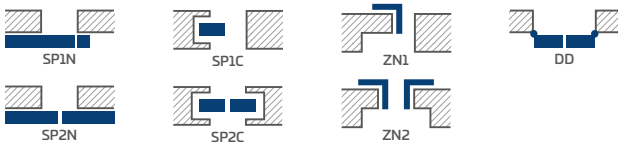

AVAILABLE DOOR LEAF WIDTHS

60 70 80N²⁾ 80 90 100

CONSTRUCTION

- rebated, non-rebated or reverse door leaf
- internal timber stiles and top rail, MDF bottom rail, covered with two HDF boards
- rigid honeycomb infill or solid core infill for additional charge
- optional door frame extension panels and a crosshead with pilasters are available for an additional charge, p. 147-149
- the door can be trimmed by a customer, go to p. 145 for details

FINISHING

- door leaves and door frames coated with water-based UV hardened varnish for high resistance to adverse use conditions
- door leaf edge made in standard technology

HARDWARE

- three pin mortise hinges in a rebated door leaf
- three concealed hinges in the non-adjacent leaf and two hinges in the reverse leaf in silver (black against an extra charge); hinges are supplied and priced with the door frame
- a lever tumbler lock in the rebated door leaf and a key-locked magnetic lock (lever tumbler lock as an option) in the non-rebated and reverse door leaves, thumb turn cylinder, economy or silver with a blockade or, optionally, for an additional charge, a black or golden magnetic lock

EXTRA CHARGES

reverse door leaf

solid core filling

door undercut (p. 145) or air gap undercut

"100" rebated and non-rebated door leaf

"110" rebated and non-rebated door leaf

additional bottom rail (can be trimmed by a customer up to max 8 cm)

metal hinge casings in the rebated door leaf (brushed nickel, patina, polished chrome, polished brass, white and black)

drop down seal¹⁾

can be replaced with a black or golden magnetic lock for non-rebated and reverse leaves

magnetic stop (buffer)¹⁾
(available in six colours p. 145)

stainless steel porthole: "chrome" polished or "satin" brushed; frosted decormat glass, non-tinted glass; porthole ID 235 mm; external 350 mm)

standard PL2112

¹⁾ a stop will not allow a drop down seal and an door undercut to be used, and vice versa

²⁾ only for non-rebated and reversed swing doors



TURAN

REBATED, NON-REBATED PAINTED DOORS



finalista konkursu
DOBRY WZÓR
2019



TURAN 4, black matt CUBE handle



TURAN 1



TURAN 2



TURAN 3



TURAN 4



TURAN 5



TURAN 6



TURAN 7¹⁾

¹⁾ the photo shows the REVERS version

TURAN 5 with CUBE handle, black matt



CONSTRUCTION

- rebated or non-rebated door leaf made in the STILE panelled technology
- MDF stiles and rails coated with a facing layer and painted with UV-resistant varnish
- 16 mm thick HDF panels, moulded and coated with UV resistant varnish
- optional door frame extension panels and a crosshead with pilasters are available for an additional charge, p. 147-149
- the door can be trimmed by a customer, go to p. 145 for details

FINISHING

- door leaves and door frames coated with water-based UV hardened varnish for high resistance to adverse use conditions

HARDWARE

- rebated door leaves: three silver 2-pin hinges adjusted horizontally
- three concealed hinges in a non-rebated leaf, silver (optionally black - subject to an additional charge); hinges supplied with and included in the price of the door frame
- lever tumbler lock in a rebated door leaf and a key-locked magnetic lock (lever tumbler lock as an option) in a non-rebated door leaf, thumb turn cylinder, economy, with a silver blockade; optionally, for an additional charge, a black or gold magnetic lock

GLAZING

- TURAN 1 model, 4 mm tempered glass or, charged extra, frosted or black VSG 221 laminated safety glass, plain on both sides
- TURAN 7 model available with a mirror on one side. Other side - varnished board WHITE TITANIUM UV. Obverse - mirror on the hinge side.

MOULDING

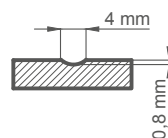

PAINTED

WHITE TITANIUM UV

EXTRA CHARGES

factory pre-drilled through holes for handles (split handles) ordered together with the door leaf

door undercut (p. 145) or air gap undercut

"100" rebated and non-rebated door leaf

metal hinge casings in the rebated door leaf (brushed nickel, patina, polished chrome, polished brass, white and black)

VSG 221 laminated safety glass, plain on both sides, frosted or black (for TURAN 1)

drop down seal¹⁾

can be replaced with a black or golden magnetic lock for non-rebated door leaves

magnetic stop (buffer)¹⁾
(available in six colours p. 145)

AVAILABLE SOLUTIONS (p. 150-161)

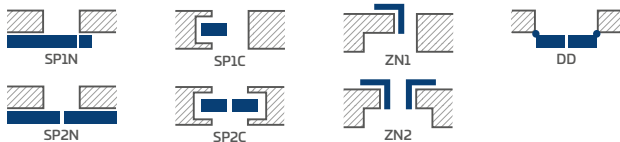

AVAILABLE DOOR LEAF WIDTHS

60 70 80N²⁾ 80 90 100

¹⁾ a stop will not allow a drop down seal and an door undercut to be used, and vice versa

²⁾ only for non-rebated door leaves



MILDA

produkt rekomendowany
do konkursu



2019

REBATED, NON-REBATED AND REVERSE PAINTED DOORS



MILDA 4, CUBE PREMIUM handle, black matt



MILDA 1



MILDA 2



MILDA 3



MILDA 4



MILDA 5

MILDA 2 with CUBE PREMIUM handle, black matt



CONSTRUCTION

- rebated, non-rebated or reverse door leaf
- internal timber stiles and top rail, MDF bottom rail, covered with two HDF boards
- rigid honeycomb infill or solid core infill for additional charge
- optional door frame extension panels and a crosshead with pilasters are available for an additional charge, p. 147-149
- the door can be trimmed by a customer, go to p. 145 for details

FINISHING

- door leaves and door frames coated with water-based UV hardened varnish for high resistance to adverse use conditions
- door leaf edge made in standard or non-rebated technology

HARDWARE

- three pin mortise hinges in a rebated door leaf
- three concealed hinges in the non-adjacent leaf and two hinges in the reverse leaf in silver (black against an extra charge); hinges are supplied and priced with the door frame
- a lever tumbler lock in the rebated door leaf and a key-locked magnetic lock (lever tumbler lock as an option) in the non-rebated and reverse door leaves, thumb turn cylinder, economy or silver with a blockade or, optionally, for an additional charge, a black or golden magnetic lock

MOULDING

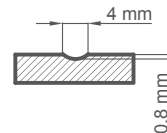

PAINTED



WHITE TITANIUM UV

EXTRA CHARGES

reverse door leaf

solid core filling

door undercut (p. 145) or air gap undercut

"100" rebated and non-rebated door leaf

additional bottom rail (can be trimmed by a customer up to max 8 cm)

metal hinge casings in the rebated door leaf (brushed nickel, patina, polished chrome, polished brass, white and black)

drop down seal ¹⁾

can be replaced with a black or golden magnetic lock for non-rebated and reverse leaves

magnetic stop (buffer) ¹⁾
(available in six colours p. 145)

standard PL2112

AVAILABLE SOLUTIONS (p. 150-161)



SP1N



SP1C



ZN1



DD

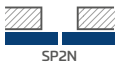

SP2N

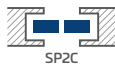

SP2C



ZN2

AVAILABLE DOOR LEAF WIDTHS

60 70 80N²⁾ 80 90 100

¹⁾ a stop will not allow a drop down seal and an door undercut to be used, and vice versa

²⁾ only for non-rebated and reversed swing doors



SYLENA

REBATED, NON-REBATED AND REVERSE PAINTED DOORS



SYLENA 5, handle: BELLA SLIM, shiny brass



SYLENA 1



SYLENA 2



SYLENA 3



SYLENA 4



SYLENA 5



SYLENA 6



SYLENA 7



SYLENA 8

SYLENA 3 with CUBE handle, black matt



CONSTRUCTION

- rebated, non-rebated or reverse door leaf
- internal timber stiles and top rail, MDF bottom rail, covered with two HDF boards
- rigid honeycomb infill or solid core infill for additional charge
- optional door frame extension panels and a crosshead with pilasters are available for an additional charge, p. 147-149
- the door can be trimmed by a customer, go to p. 145 for details

FINISHING

- door leaves and door frames coated with water-based UV hardened varnish for high resistance to adverse use conditions
- door leaf edge made in standard or non-rebated technology

HARDWARE

- three pin mortise hinges in a rebated door leaf
- three concealed hinges in the non-adjacent leaf and two hinges in the reverse leaf in silver (black against an extra charge); hinges are supplied and priced with the door frame
- a lever tumbler lock in the rebated door leaf and a key-locked magnetic lock (lever tumbler lock as an option) in the non-rebated and reverse door leaves, thumb turn cylinder, economy or silver with a blockade or, optionally, for an additional charge, a black or golden magnetic lock

MOULDING

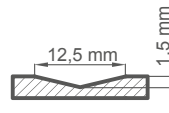

PAINTED



WHITE TITANIUM UV

EXTRA CHARGES

reverse door leaf

solid core filling

door undercut (p. 145) or air gap undercut

"100" rebated and non-rebated door leaf

additional bottom rail (can be trimmed by a customer up to max 8 cm)

metal hinge casings in the rebated door leaf (brushed nickel, patina, polished chrome, polished brass, white and black)

drop down seal ¹⁾

can be replaced with a black or golden magnetic lock for non-rebated and reverse leaves

magnetic stop (buffer) ¹⁾
(available in six colours p. 145)

standard PL2112

AVAILABLE SOLUTIONS (p. 150-161)

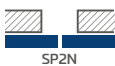
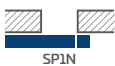

AVAILABLE DOOR LEAF WIDTHS

60 70 80N ²⁾ 80 90 100

¹⁾ a stop will not allow a drop down seal and an door undercut to be used, and vice versa

²⁾ only for non-rebated and reversed swing doors

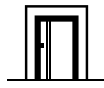

INLAYS

DECORATIVE INSERT FLUSH WITH THE FACING SURFACE



ALTAMURA 1, BLACK ST CPL facing layer; inlay LUX 421, handle CUBE PREMIUM

LUX INLAY **BLACK**

NEW



inlay LUX 217



inlay LUX 218



inlay LUX 219



inlay LUX 220



inlay LUX 221



inlay LUX 203



inlay LUX 204



inlay LUX 212



inlay LUX 213



inlay LUX 207



inlay LUX 214



inlay LUX 216

door frame: BLACK ST CPL Door leaf: OAK CLASSIC CPL

INLAYS are located on both sides of the leaf and are flush with its surface.

The inlay width is 8 mm or 50 mm.

Available colours of the LUX INLAY:
brushed steel, black, brushed gold, oak (compatible with OAK CLASSIC CPL 0.2 & 0.7), brushed copper.

You can order the presented INLAYS as options for an extra charge on the following models available to PL and PL2112 standards (if available):

- UNO PREMIUM facing
- ALTAMURA 1
- FORTECA RC2 & RC3
- HERSE SET EKO 30 dB
- HERSE SET 32 dB
- HERSE SET AKUSTIC 39 dB
- LEDA EI30, EI60
- HYPERION EI30 RC2

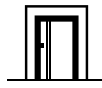

INLAYS

DECORATIVE INSERT FLUSH WITH THE FACING SURFACE

NEW

LUX INLAY **OAK**



inlay LUX 317



inlay LUX 318



inlay LUX 319



inlay LUX 320



inlay LUX 321



inlay LUX 303



inlay LUX 304



inlay LUX 312



inlay LUX 313



inlay LUX 307



inlay LUX 314



inlay LUX 316

door frame: OAK CLASSIC CPL 0.2 Door leaf: WHITE ST CPL

INLAYS are located on both sides of the leaf and are flush with its surface.

The inlay width is 8 mm or 50 mm.

Available colours of the LUX INLAY:
brushed steel, black, brushed gold, oak (compatible with OAK CLASSIC CPL 0.2 & 0.7), brushed copper.

You can order the presented INLAYS as options for an extra charge on the following models available to PL and PL2112 standards (if available):

- UNO PREMIUM FACING LAYER
- ALTAMURA 1
- FORTECA RC2 & RC3
- HERSE SET EKO 30 dB
- HERSE SET 32 dB
- HERSE SET AKUSTIK 39 dB
- LEDA EI30, EI60
- HYPERION EI30 RC2

LUX INLAY **BRUSHED GOLD**

NEW

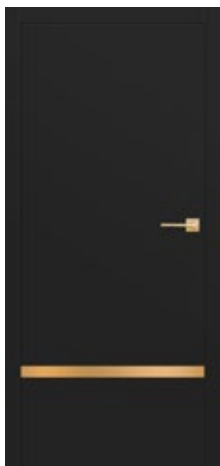

inlay LUX 417

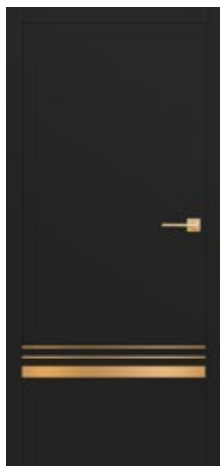

inlay LUX 418

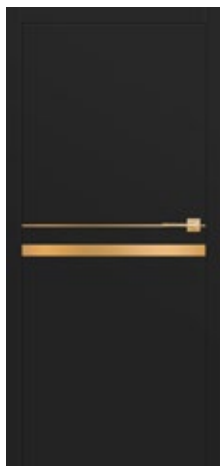

inlay LUX 419



inlay LUX 420

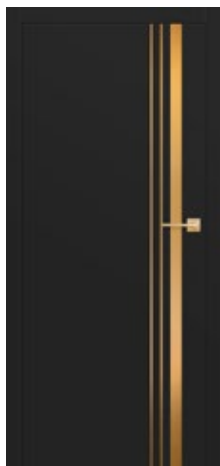

inlay LUX 421

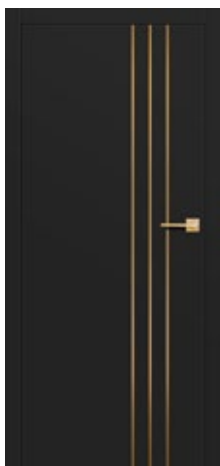

inlay LUX 403



inlay LUX 404

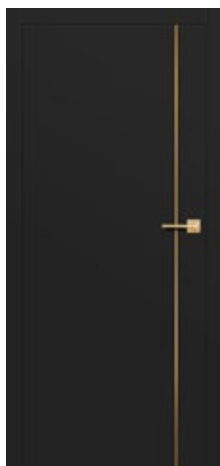

inlay LUX 412

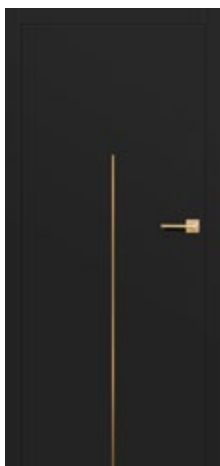

inlay LUX 413

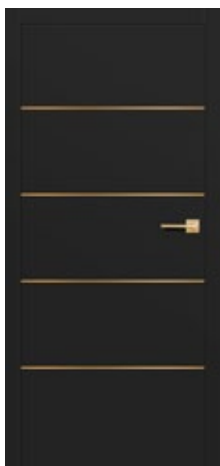

inlay LUX 407



inlay LUX 414

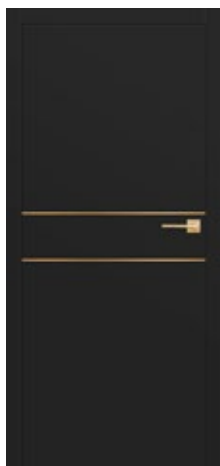

inlay LUX 416

Door frame and leaf BLACK ST CPL

INLAYS are located on both sides of the leaf and are flush with its surface.

The inlay width is 8 mm or 50 mm.

Available colours of the LUX INLAY:
brushed steel, black, brushed gold, oak (compatible with OAK CLASSIC CPL 0.2 & 0.7), brushed copper.

You can order the presented INLAYS as options for an extra charge on the following models available to PL and PL2112 standards (if available):

- UNO PREMIUM FACING LAYER
- ALTAMURA 1
- FORTECA RC2 & RC3
- HERSE SET EKO 30 dB
- HERSE SET 32 dB
- HERSE SET AKUSTIC 39 dB
- LEDA EI30, EI60
- HYPERION EI30 RC2

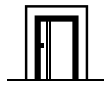

INLAYS

DECORATIVE INSERT FLUSH WITH THE FACING SURFACE

NEW

LUX INLAY **BRUSHED STEEL**



inlay LUX 117



inlay LUX 118



inlay LUX 119



inlay LUX 120



inlay LUX 121



inlay LUX 103



inlay LUX 104



inlay LUX 112



inlay LUX 113



inlay LUX 107



inlay LUX 114



inlay LUX 116

door frame and leaf: LIGHT GREY/ST CPL

INLAYS are located on both sides of the leaf and are flush with its surface.

The inlay width is 8 mm or 50 mm.

Available colours of the LUX INLAY:
brushed steel, black, brushed gold, oak (compatible with OAK CLASSIC CPL 0.2 & 0.7), brushed copper.

You can order the presented INLAYS as options for an extra charge on the following models available to PL and PL2112 standards (if available):

- UNO PREMIUM facing
- ALTAMURA 1
- FORTECA RC2 & RC3
- HERSE SET EKO 30 dB
- HERSE SET 32 dB
- HERSE SET AKUSTIC 39 dB
- LEDA EI30, EI60
- HYPERION EI30 RC2

INLAY LUX **BRUSHED COPPER**

NEW



inlay LUX 517



inlay LUX 518



inlay LUX 519



inlay LUX 520



inlay LUX 521



inlay LUX 503



inlay LUX 504

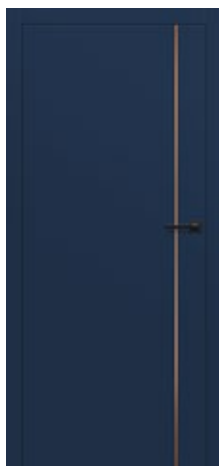

inlay LUX 512



inlay LUX 513

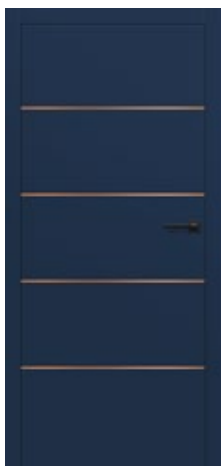

inlay LUX 507

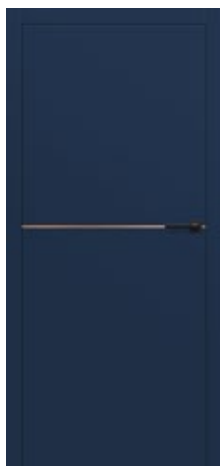

inlay LUX 514



inlay LUX 516

Door frame and leaf ROYAL.BLUE.ST.CPL

INLAYS are located on both sides of the leaf and are flush with its surface.

The inlay width is 8 mm or 50 mm.

Available colours of the LUX INLAY:
brushed steel, black, brushed gold, oak (compatible with OAK CLASSIC CPL 0.2 & 0.7), brushed copper.

You can order the presented INLAYS as options for an extra charge on the following models available to PL and PL2112 standards (if available):

- UNO PREMIUM facing
- ALTAMURA 1
- FORTECA RC2 & RC3
- HERSE SET EKO 30 dB
- HERSE SET 32 dB
- HERSE SET AKUSTIC 39 dB
- LEDA EI30, EI60
- HYPERION EI30 RC2



BALDUR

REBATED, NON-REBATED AND REVERSE INTERIOR DOORS



BALDUR 1, HORIZONTAL NATUR OAK PREMIUM facing layer, door frame facing layer: BLACK ST CPL, handle: QUBIK, black matt

BALDUR 1 in OAK RETRO CPL facing layer, door frame: BLACK ST CPL with CUBE PREMIUM handle, black matt

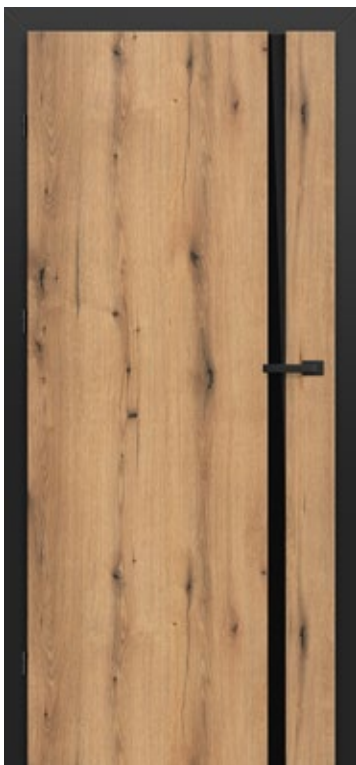

BALDUR 1

BALDUR 3 in OAK RETRO CPL facing layer, door frame: BLACK ST CPL with CUBE PREMIUM handle, black matt



BALDUR 3

BALDUR 1 in OAK CLASSIC CPL facing layer, door frame: BLACK ST CPL with CUBE PREMIUM handle, black matt



BALDUR 1

CONSTRUCTION

- rebated, non-rebated or reverse door leaf
- internal timber stiles and top rail, MDF bottom rail, covered with two HDF boards
- rigid honeycomb infill or solid core infill for additional charge
- optional door frame extension panels and a crosshead with pilasters are available for an additional charge, p. 147-149

FINISHING

- HDF board in PREMIUM or CPL facing
- leaf edge made in the standard rebated or non-rebated technology with CPL 0.2 laminates, faced with the ABS edging, and in the same colour as the leaf only or, for an additional charge, with a standard black edge
- reverse door leaf only in with the STANDARD edge and with the PREMIUM and ST CPL facings
- the door edge faced with edging in the same colour as the door leaf plane or optionally in black plain edging (black edging with horizontal grain for the HORIZONTAL NATUR OAK PREMIUM facing). Door edge faced with black layers around a part of the circumference (two vertical edges and the top one) and next to the glass.
- rebated and non-rebated door leaf BALDUR 1 only for the WHITE ST CPL facing made optionally in the Soft technology (invisible longitudinal edge joints of the facing), requiring the use of a solid core at an extra charge. The Soft technology is not included in the PL2112 standard.
- the BALDUR 1 sliding systems have a visible 17 mm high aluminium or black coloured profile in the lower part of the glass pane

HARDWARE

- three pin mortise hinges in a rebated door leaf
- three concealed hinges in the non-adjacent leaf and two hinges in the reverse leaf in silver (black against an extra charge); hinges are supplied and priced with the door frame
- a lever tumbler lock in the rebated door leaf and a key-locked magnetic lock (lever tumbler lock as an option) in the non-rebated and reverse door leaves, thumb turn cylinder, economy or silver with a blockade or, optionally, for an additional charge, a black or golden magnetic lock

GLAZING

- BALDUR 1, 3: 8 mm tempered frosted glass or VSG/ESG 441 safety glass, frosted or black, plain on both sides

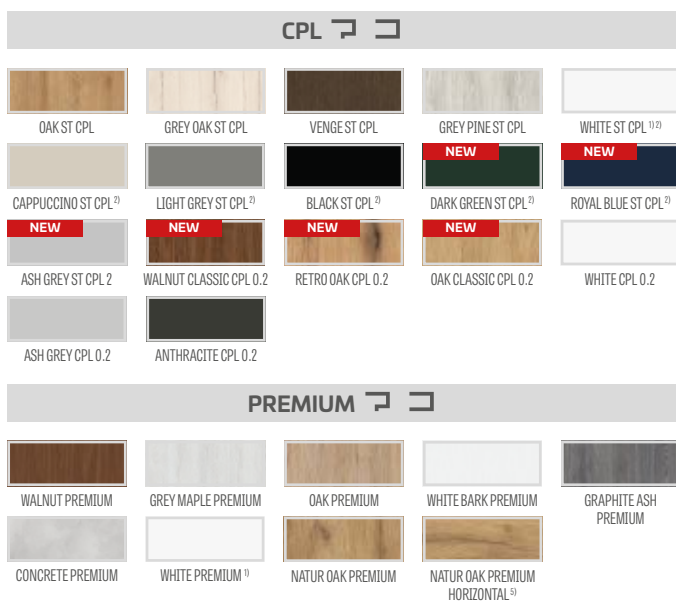

EXTRA CHARGES

reverse door leaf

(unavailable for CPL 0.2 and for BALDUR 1 with SOFT edge)

solid core filling

door undercut (p. 145) or air gap undercut

"100" rebated and non-rebated door leaf

frosted or black VSG/ESG 441 glazing

metal hinge casings in the rebated door leaf (brushed nickel, patina, polished chrome, polished brass, white and black)

black door leaf edge finish

can be replaced with a black or golden magnetic lock for non-rebated and reverse leaves

magnetic stop (buffer)

(available in six colours p. 145)

PL2112 standard

+ 15% on the door price before surcharges

AVAILABLE DOOR LEAF WIDTHS

60 70 80N⁶⁾ 80 90 100

AVAILABLE SOLUTIONS³⁾ (p. 150-161)



EDGE FINISH TYPES

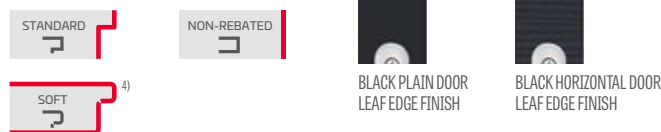

AIR GAP UNDERCUT



¹⁾ plain white facing imitating a painted surface

²⁾ special AntiFinger coating to reduce dirt and fingerprints

³⁾ the BALDUR 3 model not available in sliding systems or double doors

⁴⁾ only soft version for BALDUR 1 rebated and non-rebated with WHITE ST CPL facing layer and only available at an extra charge with solid core (the Soft option not included in the PL2112 standard)

⁵⁾ comes complete with the NATUR OAK PREMIUM door frame

⁶⁾ only for non-rebated and reversed swing doors



BALDUR

REBATED, NON-REBATED AND REVERSE INTERIOR DOORS



BALDUR 3, CAPPUCCINO ST CPL facing layer, handle: CUBE, black matt

BALDUR 1 in ASH GREY ST CPL facing layer, door frame: BLACK ST CPL with QUANTA FIT handle, black matt

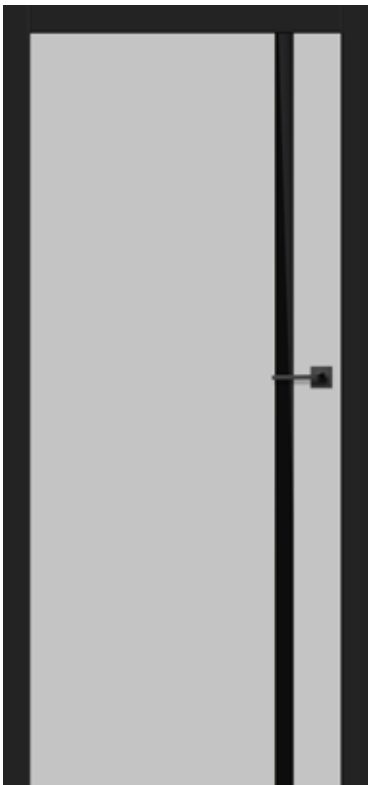

BALDUR 3 in WALNUT CLASSIC CPL facing layer, door frame: BLACK ST CPL with QUANTA FIT handle, black matt



BALDUR 1 in GREY PINE ST CPL facing layer, door frame: BLACK ST CPL with QUANTA FIT handle, black matt





BALDUR 1, LIGHT GREY ST CPL facing layer, TOPAZ INOX handle

BALDUR 1 in BLACK ST CPL facing layer, door frame: OAK NATUR PREMIUM with BELLA SLIM handle, glossy brass

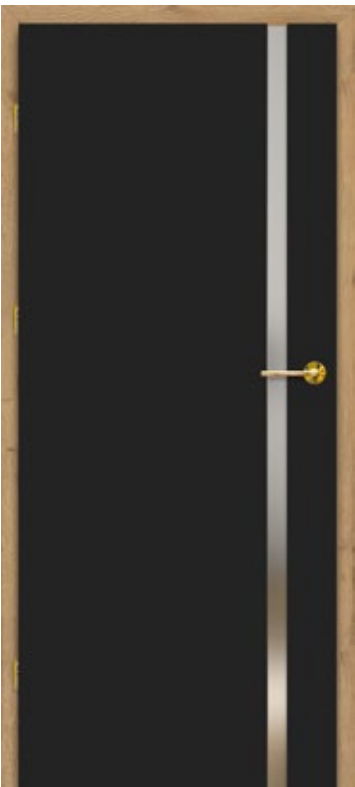

BALDUR 3 in ROYAL BLUE ST CPL facing layer with CUBE handle, black matt



BALDUR 1 in DARK GREEN ST CPL facing layer with CUBE handle, black matt





UNO PREMIUM

REBATED, NON-REBATED AND REVERSE INTERIOR DOORS



UNO PREMIUM, HORIZONTAL NATUR OAK PREMIUM facing layer, door frame: BLACK ST CPL, handle: CUBE, black matt

UNO PREMIUM in HORIZONTAL NATUR OAK PREMIUM with CUBE handle, black matt



UNO PREMIUM in GRAPHITE ASH PREMIUM facing layer with CUBE handle, black matt



UNO PREMIUM with WALNUT PREMIUM facing layer with CUBE handle, black matt



UNO PREMIUM with WHITE PREMIUM facing layer with BELLA SLIM handle, black matt



CONSTRUCTION

- rebated, non-rebated or reverse door leaf
- internal timber stiles and top rail, MDF bottom rail, covered with two HDF boards
- rigid honeycomb infill
- solid core filling for additional charge
- optional door frame extension panels and a crosshead with pilasters are available for an additional charge, p. 147-149
- the door can be trimmed by a customer, go to p. 145 for details

FINISHING

- HDF board with PREMIUM facing
- door leaf edge made in standard rebated or non-rebated technology
- the door edge faced with edging in the same colour as the door leaf plane or optionally in black plain edging (black edging with horizontal grain for the HORIZONTAL NATUR OAK PREMIUM facing)
- insert (inlay) colour: brushed steel, black, brushed gold and OAK CLASSIC CPL with a width of 8 mm or 50 mm flush with the door leaf, made on both sides of the leaf, p. 86-91

HARDWARE

- three pin mortise hinges in a rebated door leaf
- three concealed hinges in the non-adjacent leaf and two hinges in the reverse leaf in silver (black against an extra charge); hinges are supplied and priced with the door frame
- lever tumbler lock on the rebated doors and a magnetic lock on the non-rebated doors (lever tumbler lock as an option) and reversed swing doors: with a key, thumb turn cylinder; economy or with silver, with a blockade; optionally, against an extra charge, a black or golden magnetic lock

AVAILABLE SOLUTIONS (p. 150-161)

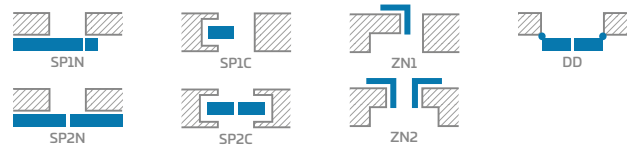

EXTRA CHARGES

- reverse door leaf
- solid core filling
- door closer reinforcement
- arm door closer (silver; black, white, brown)
- additional bottom rail (can be trimmed by a customer up to max 8 cm)
- round and square metal sleeves (4 pcs); brushed nickel or patina finish, white and black
- plastic woodgrain sleeves (4 pcs)
- door undercut (p. 145), air gap undercut or ventilation grille
- "100" rebated and non-rebated door leaf
- "110" rebated and non-rebated door leaf
- drop down seal²⁾
- metal hinge casings in the rebated door leaf (brushed nickel, patina, polished chrome, polished brass, white and black)
- stainless steel porthole: "chrome" polished or "satin" brushed; frosted decormat glass, non-tinted glass; porthole ID 235 mm external 350 mm)
- black door leaf edge finish
- can be replaced with a black or golden magnetic lock for non-rebated and reverse leaves
- magnetic stop (buffer)²⁾ (available in six colours p. 145)
- LUX inlay; available versions p. 86-91
- PL2112 standard + 15% on the door price before surcharges

PREMIUM

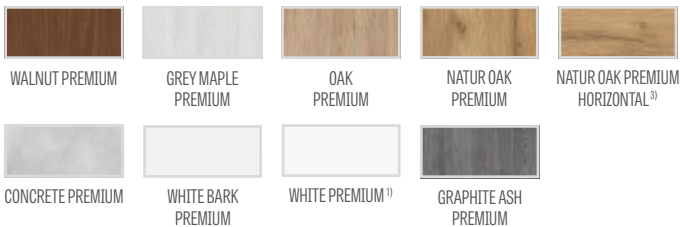

AVAILABLE DOOR LEAF WIDTHS

60 70 80N⁴⁾ 80 90 100 110

EDGE FINISH TYPES

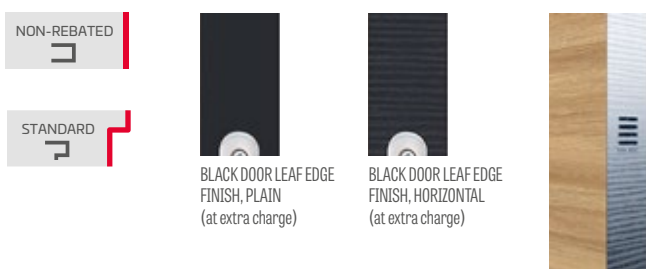

¹⁾ plain white facing imitating a painted surface

²⁾ a stop will not allow a drop down seal and an door undercut to be used, and vice versa

³⁾ comes complete with the NATUR OAK PREMIUM door frame

⁴⁾ only for non-rebated and reversed swing doors



ALTAMURA

REBATED, NON-REBATED AND REVERSE INTERIOR DOORS

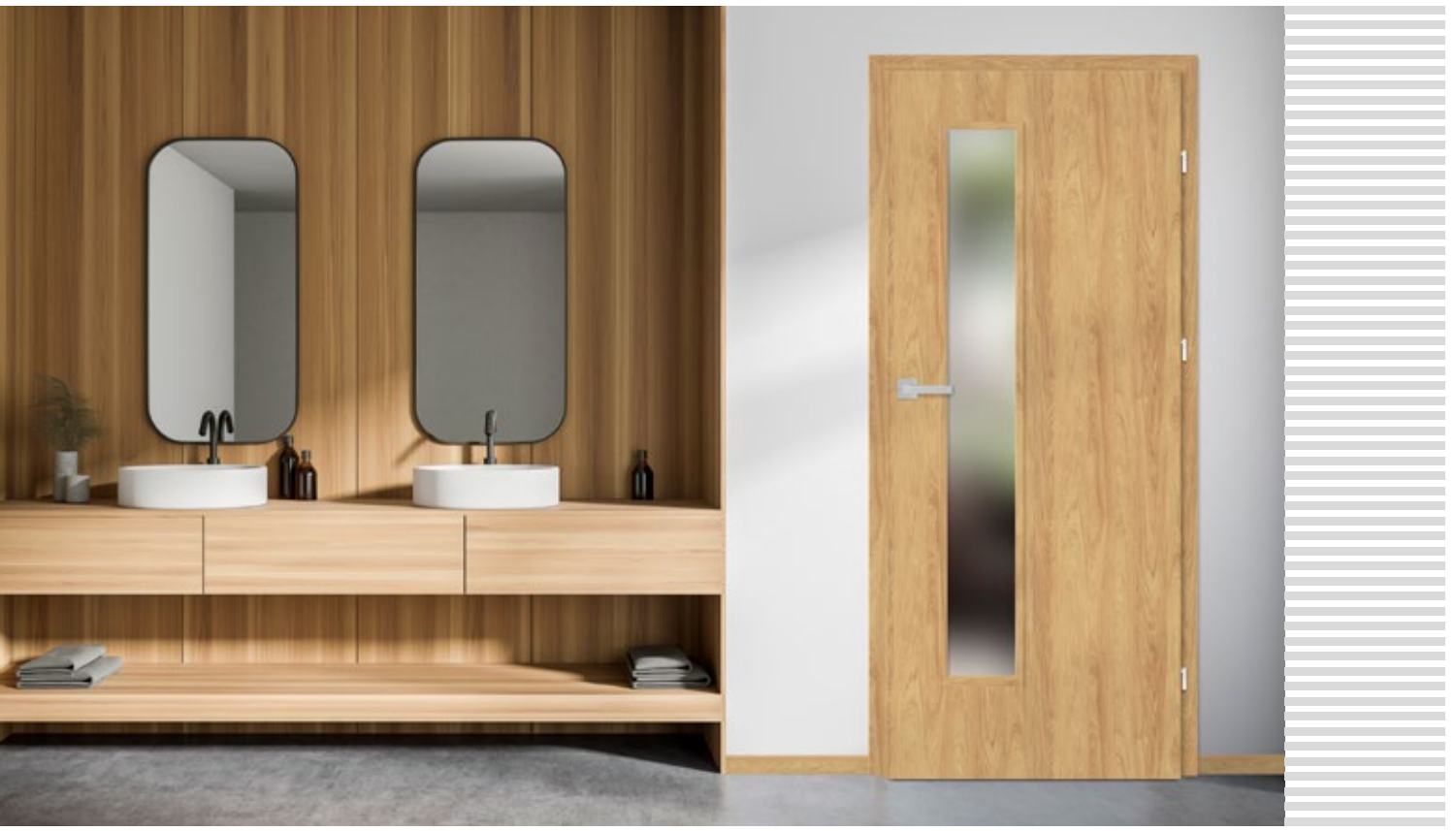

ALTAMURA 5, OAK CLASSIC CPL facing layer, handle: TOPAZ, stainless steel



ALTAMURA 1



ALTAMURA 2



ALTAMURA 3



ALTAMURA 4



Middle panel



ALTAMURA 5

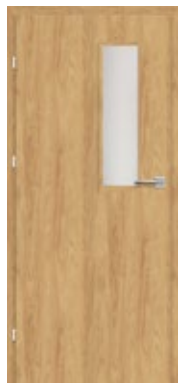

ALTAMURA 6



ALTAMURA 7



ALTAMURA 8

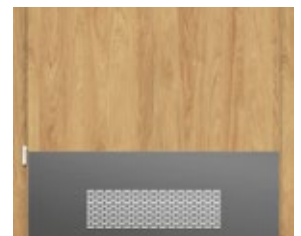

grille panel

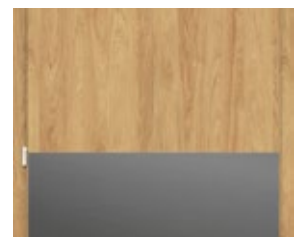

Bottom panel

CONSTRUCTION

- rebated, non-rebated or reverse door leaf
- MDF stiles and rails covered with two HDF boards in GREKO decors
- internal timber stiles and top rail, MDF bottom rail, covered with two HDF boards in CPL and PREMIUM facing layer
- rigid honeycomb infill or solid core infill for additional charge
- optional door frame extension panels and a crosshead with pilasters are available for an additional charge, p. 147-149
- the door can be trimmed by a customer, go to p. 145 for details

FINISHING

- HDF board with a facing layer
- door leaf edge made in the STANDARD technology
- CPL 0.2 & 0.7 laminates available only with the STANDARD edge with the ABS edging in the same colour as the door leaf only or, for an additional charge, with a standard black edge
- edge (in standard or non-rebated finish) faced with an edging in the same colour as the surface or, optionally, in plain black (black edging with transverse NATUR OAK PREMIUM, a black edge with a transverse structure)
- for ALTAMURA 1, inlays are available for an additional charge, as shown on p. 86-91

HARDWARE

- three pin mortise hinges in a rebated door leaf
- three concealed hinges in the non-adjacent leaf and two hinges in the reverse leaf in silver (black or golden against an extra charge); hinges are supplied and priced with the door frame
- a lever tumbler lock in the rebated door leaf and a key-locked magnetic lock (lever tumbler lock as an option) in the non-rebated and reverse door leaves, thumb turn cylinder, economy or silver with a blockade or, optionally, for an additional charge, a black or golden magnetic lock

GLAZING

- **tempered frosted Decormat glass as standard**, clear or, charged extra, frosted VSG 221 safety glass, plain on both sides
- possibility to change the glazing side to REVERSE (standard glazing for OBVERSE)

EXTRA CHARGES

reverse door leaf (unavailable for CPL 0.2 and 0.7)

solid core filling

door closer reinforcement

arm door closer (silver; black, white, brown)

additional bottom rail (can be trimmed by a customer up to max 8 cm)

door undercut (p. 145), air gap undercut or ventilation grille

metal round or square ventilation sleeves (4 pcs);

brushed nickel or patina finish in white or black

plastic sleeves

rebated and non-rebated leaf "100" rebated and non-rebated leaf "110"

frosted VSG 221 laminated glass

drop down seal ²⁾

metal hinge casings in the rebated door leaf (brushed nickel, patina, polished chrome, polished brass, white and black)

ALTAMURA 1: stainless steel porthole: polished "chrome" or brushed "satin" and black matt; frosted decormat glass, non-tinted glass; porthole diameter: internal: 235 mm; external 350 mm)

stainless steel panel (fitted on both sides in the rebated STANDARD door leaves only), height 300mm

black door leaf edge finish

can be replaced with a black or golden magnetic lock for non-rebated and reverse leaves

magnetic stop (buffer) ²⁾

(available in six colours p. 145)

ALTAMURA 1 model: LUX inlay; available versions p. 86-91

PL2112 standard

+ 15% on the door price before surcharges

GREKO

WALNUT GREKO	SANREMO GREKO	SONOMA GREKO	MEDIUM OAK GREKO	ELM GREKO
GOLDEN OAK GREKO	GREY OAK GREKO	LIGHT ACACIA GREKO	WHITE GREKO ¹⁾	SNOW-WHITE GREKO ¹⁾
OAK GREKO				

CPL

OAK ST CPL	GREY OAK ST CPL	VENGE ST CPL	GREY PINE ST CPL	WHITE ST CPL ^{1) 3)}
CAPPUCCINO ST CPL ³⁾	LIGHT GREY ST CPL ³⁾	BLACK ST CPL ³⁾	DARK GREEN ST CPL ³⁾	ROYAL BLUE ST CPL ³⁾
ASH GREY ST CPL 3	WHITE CPL 0.2 & 0.7	ASH GREY CPL 0.2 & 0.7	ANTHRACITE CPL 0.2 & 0.7	
WALNUT CLASSIC CPL 0.2 & 0.7	OAK RETRO CPL 0.2 & 0.7	OAK CLASSIC CPL 0.2 & 0.7		

PREMIUM

WALNUT PREMIUM	GREY MAPLE PREMIUM	OAK PREMIUM	WHITE BARK PREMIUM	GRAPHITE ASH PREMIUM
CONCRETE PREMIUM	WHITE PREMIUM ¹⁾	NATUR OAK PREMIUM	NATUR OAK PREMIUM HORIZONTAL ⁴⁾	

AVAILABLE DOOR LEAF WIDTHS

60 70 80N⁵⁾ 80 90 100 110

GLASS FRAME



AVAILABLE SOLUTIONS (p. 150-161)

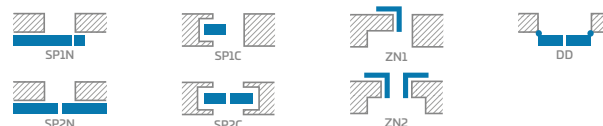

EDGE FINISH TYPES

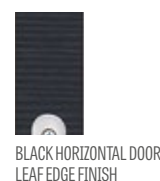
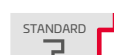

¹⁾ plain white facing imitating a painted surface

²⁾ a stop will not allow a drop down seal and an door undercut to be used, and vice versa

³⁾ special AntiFinger coating to reduce dirt and fingerprints

⁴⁾ comes complete with the NATUR OAK PREMIUM door frame

⁵⁾ only for non-rebated and reversed swing doors



ANSEDONIA

REBATED, NON-REBATED AND REVERSE INTERIOR DOORS



ANSEDONIA 4, GREY OAK ST CPL facing layer, TOPAZ INOX handle



ANSEDONIA 1



ANSEDONIA 2



ANSEDONIA 3



ANSEDONIA 4



ANSEDONIA 5



ANSEDONIA 6



ANSEDONIA 7



ANSEDONIA 8



ANSEDONIA 9



ANSEDONIA 10



ANSEDONIA 11



ANSEDONIA 12

CONSTRUCTION

- rebated, non-rebated or reverse door leaf
- MDF stiles and rails covered with two HDF boards in GREKO decors
- internal timber stiles and top rail, MDF bottom rail, covered with two HDF boards in CPL and PREMIUM facing layer
- rigid honeycomb infill or solid core infill for additional charge
- optional door frame extension panels and a crosshead with pilasters are available for an additional charge, p. 147-149
- the door can be trimmed by a customer, go to p. 145 for details

FINISHING

- HDF board with a facing layer
- door leaf edge made in the STANDARD technology.
- CPL 0.2 & 0.7 laminates available only with the STANDARD edge with the ABS edging in the same colour as the door leaf only or, for an additional charge, with a standard black edge edge (in standard or non-rebated finish) faced with an edging in the same colour as the surface or, optionally, in plain black (black edging with transverse NATUR OAK PREMIUM, a black edge with a transverse structure)

HARDWARE

- three pin mortise hinges in a rebated door leaf
- three concealed hinges in the non-adjacent leaf and two hinges in the reverse leaf in silver (black or golden against an extra charge); hinges are supplied and priced with the door frame
- a lever tumbler lock in the rebated door leaf and a key-locked magnetic lock (lever tumbler lock as an option) in the non-rebated and reverse door leaves, thumb turn cylinder, economy or silver with a blockade or, optionally, for an additional charge, a black or golden magnetic lock

GLAZING

- **tempered frosted Decormat glass as standard**, clear or, charged extra, frosted VSG 221 safety glass, plain on both sides
- possibility to change the glazing side to REVERSE (standard glazing for OBTVERSE)

EXTRA CHARGES

reverse door leaf

(not available in CPL 0.2 & 0.7)

solid core filling

door closer reinforcement

arm door closer (silver, black, white, brown)

additional bottom rail (can be trimmed by a customer up to max 8 cm)

door undercut (p. 145), air gap undercut or ventilation grille

plastic sleeves

metal round or square ventilation sleeves (4 pcs);

brushed nickel or patina finish in white or black

"100" rebated and non-rebated door leaf

frosted VSG 221 laminated glass, plain on both sides

drop down seal²⁾

metal hinge casings in the rebated door leaf (brushed nickel, patina, polished chrome, polished brass, white and black)

black door leaf edge finish

can be replaced with a black or golden magnetic lock for non-rebated and reverse leaves

magnetic stop (buffer)²⁾

(available in six colours p. 145)

PL2112 standard

+ 15% on the door price before surcharges

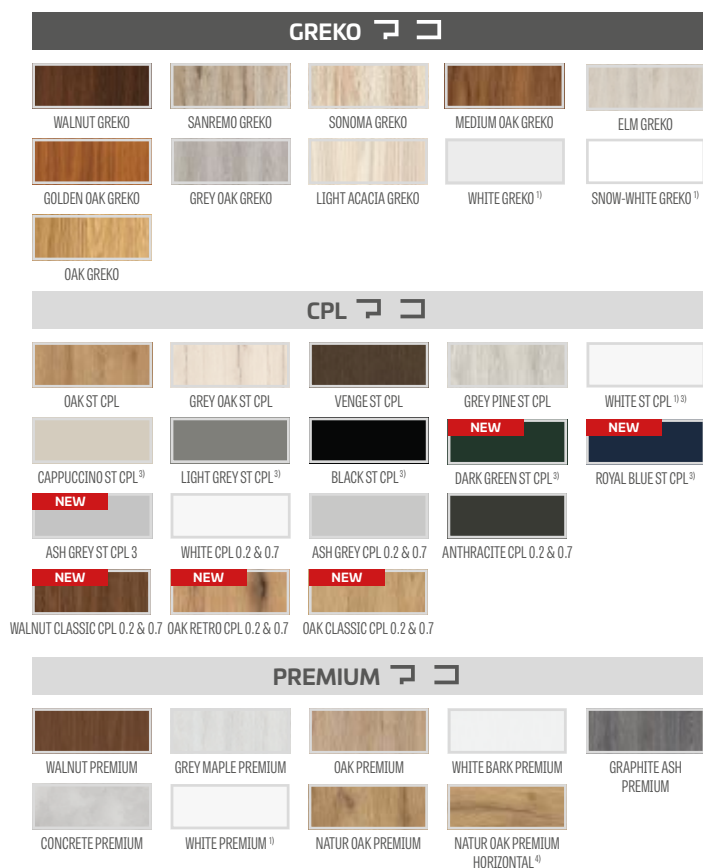

AVAILABLE DOOR LEAF WIDTHS

60 70 80N⁵⁾ 80 90 100

GLASS FRAME



AVAILABLE SOLUTIONS (p. 150-161)

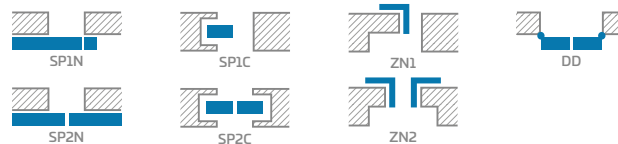

EDGE FINISH TYPES

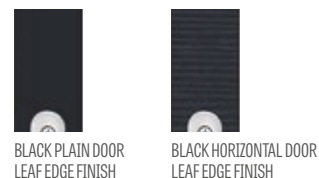

¹⁾ plain white facing imitating a painted surface

²⁾ a stop will not allow a drop down seal and an door undercut to be used, and vice versa

³⁾ special AntiFinger coating to reduce dirt and fingerprints

⁴⁾ comes complete with the NATUR OAK PREMIUM door frame

⁵⁾ only for non-rebated and reversed swing doors



LORIENT

REBATED, NON-REBATED AND REVERSE INTERIOR DOORS



LORIENT 1, GREY MAPLE PREMIUM facing layer, TOPAZ INOX handle



LORIENT 1



LORIENT 2



LORIENT 3



LORIENT 4



LORIENT 5



LORIENT 6



LORIENT 7



LORIENT 8



LORIENT 9



LORIENT 10



LORIENT 11



LORIENT 12

CONSTRUCTION

- rebated, non-rebated or reverse door leaf
- MDF stiles and rails covered with two HDF boards in GREKO decors
- internal timber stiles and top rail, MDF bottom rail, covered with two HDF boards in CPL and PREMIUM facing layer
- rigid honeycomb infill or solid core infill for additional charge
- optional door frame extension panels and a crosshead with pilasters are available for an additional charge, p. 147-149
- the door can be trimmed by a customer, go to p. 145 for details

FINISHING

- HDF board with a facing layer
- door leaf edge made in the STANDARD technology.
- edge (in standard or non-rebated finish) faced with an edging in the same colour as the surface or, optionally, in plain black (black edging with transverse NATUR OAK PREMIUM, a black edge with a transverse structure)

HARDWARE

- three pin mortise hinges in a rebated door leaf
- three concealed hinges in the non-adjacent leaf and two hinges in the reverse leaf in silver (black or golden against an extra charge); hinges are supplied and priced with the door frame
- a lever tumbler lock in the rebated door leaf and a key-locked magnetic lock (lever tumbler lock as an option) in the non-rebated and reverse door leaves, thumb turn cylinder, economy or silver with a blockade or, optionally, for an additional charge, a black or golden magnetic lock

GLAZING

- **tempered frosted Decormat glass as standard**, clear or, charged extra, frosted VSG 221 safety glass, plain on both sides
- possibility to change the glazing side to REVERSE (standard glazing for OBVERSE)

EXTRA CHARGES

reverse door leaf	
solid core filling	
door closer reinforcement	
arm door closer (silver, black, white, brown)	
additional bottom rail (can be trimmed by a customer up to max 8 cm)	
door undercut (p. 145), air gap undercut or ventilation grille	
plastic sleeves	
metal round or square ventilation sleeves (4 pcs); brushed nickel or patina finish in white or black	
"100" rebated and non-rebated door leaf	
frosted VSG 221 laminated glass, plain on both sides	
drop down seal ²⁾	
metal hinge casings in the rebated door leaf (brushed nickel, patina, polished chrome, polished brass, white and black)	
black door leaf edge finish	
can be replaced with a black or golden magnetic lock for non-rebated and reverse leaves	
magnetic stop (buffer) ²⁾ (available in six colours p. 145)	
PL2112 standard	+ 15% on the door price before surcharges

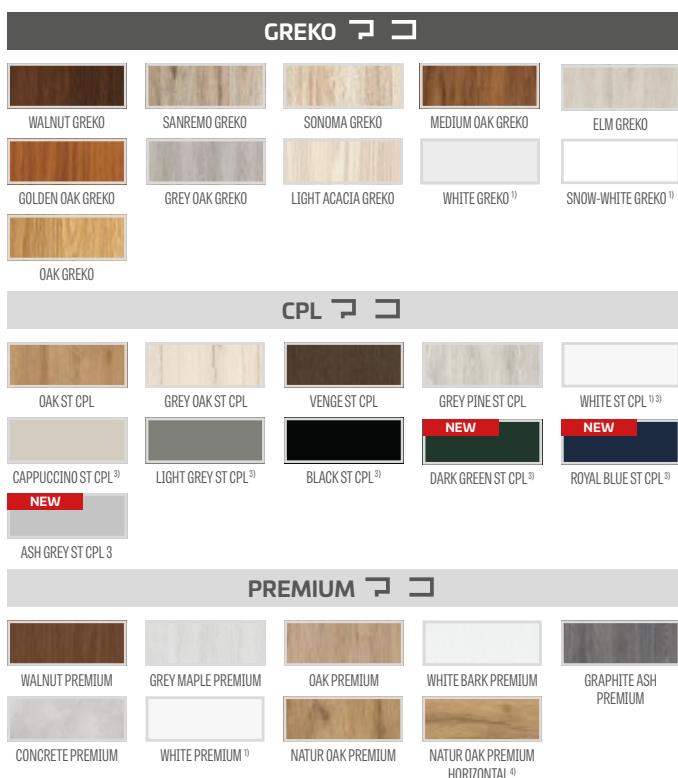

AVAILABLE DOOR LEAF WIDTHS

60 70 80N⁵⁾ 80 90 100

GLASS FRAME



AVAILABLE SOLUTIONS (p. 150-161)

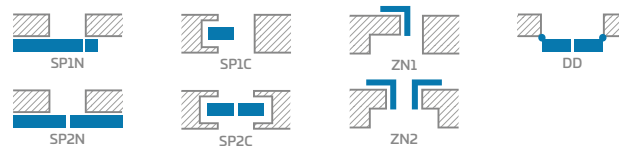

EDGE FINISH TYPES

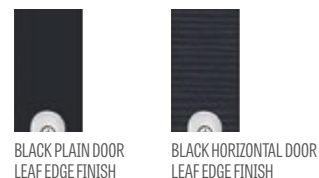

- ¹⁾ plain white facing imitating a painted surface
- ²⁾ a stop will not allow a drop down seal and an door undercut to be used, and vice versa
- ³⁾ special AntiFinger coating to reduce dirt and fingerprints
- ⁴⁾ comes complete with the NATUR OAK PREMIUM door frame
- ⁵⁾ only for non-rebated and reversed swing doors



MENTON

REBATED, NON-REBATED AND REVERSE INTERIOR DOORS

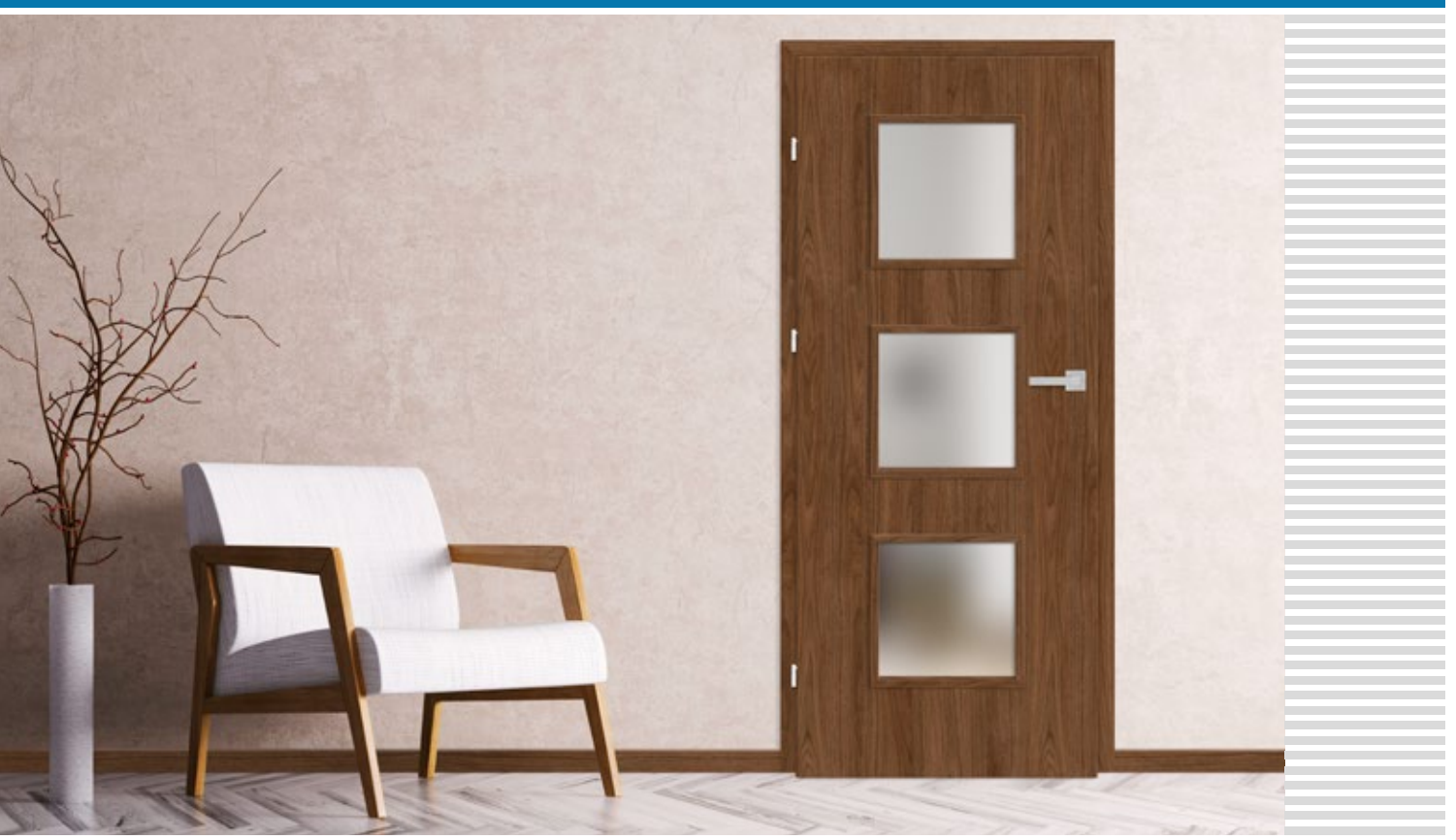

MENTON 1, WALNUT CLASSIC CPL facing layer, TOPAZ, stainless steel



MENTON 1



MENTON 2



MENTON 3



MENTON 4



MENTON 5



MENTON 6



MENTON 7



MENTON 8



MENTON 9



MENTON 10



MENTON 11



MENTON 12

CONSTRUCTION

- rebated, non-rebated or reverse door leaf
- MDF stiles and rails covered with two HDF boards in GREKO decors
- internal timber stiles and top rail, MDF bottom rail, covered with two HDF boards in CPL and PREMIUM facing layer
- rigid honeycomb infill or solid core infill for additional charge
- optional door frame extension panels and a crosshead with pilasters are available for an additional charge, p. 147-149
- the door can be trimmed by a customer, go to p. 145 for details

FINISHING

- door leaf edge made in the STANDARD technology.
- CPL 0.2 & 0.7 laminates available only with the STANDARD edge with the ABS edging in the same colour as the door leaf only or, for an additional charge, with a standard black edge
- edge (in standard or non-rebated finish) faced with an edging in the same colour as the surface or, optionally, in plain black (black edging with transverse NATUR OAK PREMIUM, a black edge with a transverse structure)

HARDWARE

- three pin mortise hinges in a rebated door leaf
- three concealed hinges in the non-adjacent leaf and two hinges in the reverse leaf in silver (black or golden against an extra charge); hinges are supplied and priced with the door frame
- a lever tumbler lock in the rebated door leaf and a key-locked magnetic lock (lever tumbler lock as an option) in the non-rebated and reverse door leaves, thumb turn cylinder, economy or silver with a blockade or, optionally, for an additional charge, a black or golden magnetic lock

GLAZING

- **tempered frosted Decormat glass as standard**, clear or, charged extra, frosted VSG 221 safety glass, plain on both sides
- possibility to change the glazing side to REVERSE (standard glazing for OBVERSE)

EXTRA CHARGES

reverse door leaf

(not available in CPL 0.2 & 0.7)

solid core filling

door closer reinforcement

arm door closer (silver, black, white, brown)

additional bottom rail (can be trimmed by a customer up to max 8 cm)

door undercut (p. 145), air gap undercut or ventilation grille

metal round or square ventilation sleeves (4 pcs);

brushed nickel or patina finish in white or black

plastic sleeves

"100" rebated and non-rebated door leaf

frosted VSG 221 laminated glass

drop down seal²⁾

metal hinge casings in the rebated door leaf (brushed nickel, patina, polished chrome, polished brass, white and black)

black door leaf edge finish

can be replaced with a black or golden magnetic lock for non-rebated and reverse leaves

magnetic stop (buffer)²⁾

(available in six colours p. 145)

PL2112 standard

+ 15% on the door price before surcharges

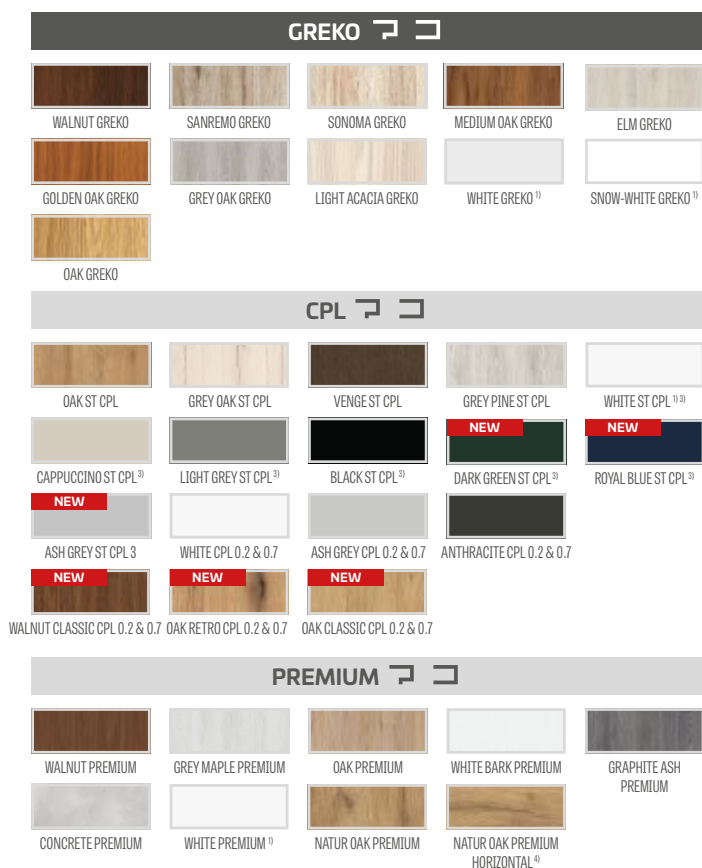

AVAILABLE DOOR LEAF WIDTHS

60 70 80N⁵⁾ 80 90 100

GLASS FRAME



AVAILABLE SOLUTIONS (p. 150-161)

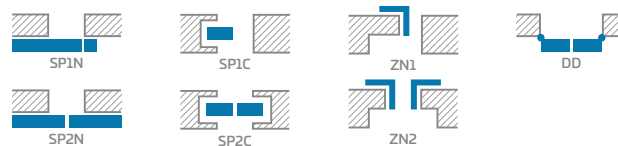

EDGE FINISH TYPES



BLACK PLAIN DOOR LEAF EDGE FINISH



BLACK HORIZONTAL DOOR LEAF EDGE FINISH

¹⁾ plain white facing imitating a painted surface

²⁾ a stop will not allow a drop down seal and a door undercut to be used, and vice versa

³⁾ special AntiFinger coating to reduce dirt and fingerprints

⁴⁾ comes complete with the NATUR OAK PREMIUM door frame

⁵⁾ only for non-rebated and reversed swing doors



SORANO

REBATED, NON-REBATED AND REVERSE INTERIOR DOORS



SORANO 1, WENGE ST CPL facing layer, handle: TOPAZ, stainless steel



SORANO 1



SORANO 2



SORANO 3



SORANO 4



SORANO 5



SORANO 6



SORANO 7



SORANO 8



SORANO 9



SORANO 10



SORANO 11



SORANO 12

CONSTRUCTION

- rebated, non-rebated or reverse door leaf
- MDF stiles and rails covered with two HDF boards in GREKO decors
- internal timber stiles and top rail, MDF bottom rail, covered with two HDF boards in CPL and PREMIUM facing layer
- rigid honeycomb infill or solid core infill for additional charge
- optional door frame extension panels and a crosshead with pilasters are available for an additional charge, p. 147-149
- the door can be trimmed by a customer, go to p. 145 for details

FINISHING

- door leaf edge made in the STANDARD technology.
- CPL 0.2 & 0.7 laminates available only with the STANDARD edge with the ABS edging in the same colour as the door leaf only or, for an additional charge, with a standard black edge
- edge (in standard or non-rebated finish) faced with an edging in the same colour as the surface or, optionally, in plain black (black edging with transverse NATUR OAK PREMIUM, a black edge with a transverse structure)

HARDWARE

- three pin mortise hinges in a rebated door leaf
- three concealed hinges in the non-adjacent leaf and two hinges in the reverse leaf in silver (black or golden against an extra charge); hinges are supplied and priced with the door frame
- a lever tumbler lock in the rebated door leaf and a key-locked magnetic lock (lever tumbler lock as an option) in the non-rebated and reverse door leaves, thumb turn cylinder, economy or silver with a blockade or, optionally, for an additional charge, a black or golden magnetic lock

GLAZING

- **tempered frosted Decormat glass as standard**, clear or, charged extra, frosted VSG 221 safety glass, plain on both sides
- possibility to change the glazing side to REVERSE (standard glazing for OBVERSE)

EXTRA CHARGES

reverse door leaf

(not available in CPL 0.2 & 0.7)

solid core filling

door closer reinforcement

arm door closer (silver, black, white, brown)

additional bottom rail (can be trimmed by a customer up to max 8 cm)

door undercut (p. 145), air gap undercut or ventilation grille

metal round or square ventilation sleeves (4 pcs);

brushed nickel or patina finish in white or black

plastic sleeves

"100" rebated and non-rebated door leaf

frosted VSG 221 laminated glass

drop down seal²⁾

metal hinge casings in the rebated door leaf (brushed nickel, patina, polished chrome, polished brass, white and black)

black door leaf edge finish

can be replaced with a black or golden magnetic lock for non-rebated and reverse leaves

magnetic stop (buffer)²⁾

(available in six colours p. 145)

PL2112 standard

+ 15% on the door price before surcharges

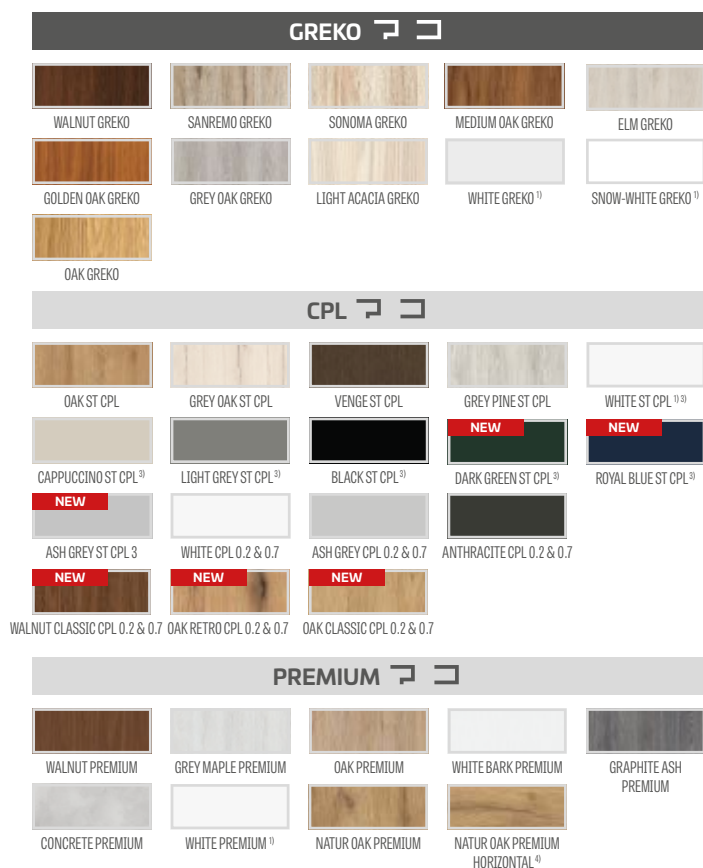

AVAILABLE DOOR LEAF WIDTHS

60 70 80N⁵⁾ 80 90 100

GLASS FRAME



AVAILABLE SOLUTIONS (p. 150-161)

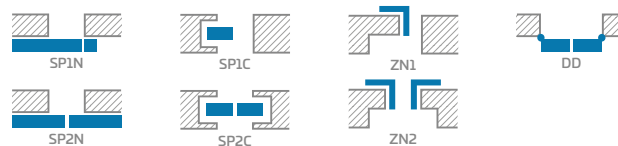

EDGE FINISH TYPES

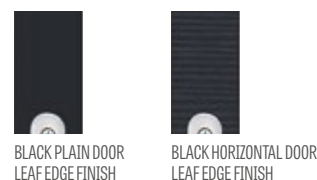

¹⁾ plain white facing imitating a painted surface

²⁾ a stop will not allow a drop down seal and a door undercut to be used, and vice versa

³⁾ special AntiFinger coating to reduce dirt and fingerprints

⁴⁾ comes complete with the NATUR OAK PREMIUM door frame

⁵⁾ only for non-rebated and reversed swing doors



FORTECA RC2 & RC3

OPENING INWARDS/OUTWARDS RC2 & RC3 BURGLARPROOF REBATED DOORS



FORTECA RC 3, facing layer: GRAPHITE ASH PREMIUM



2 HOOK BOLTS



UPPER AND LOWER SECURITY LOCKS



FOUR ADJUSTABLE STRIKE PLATES

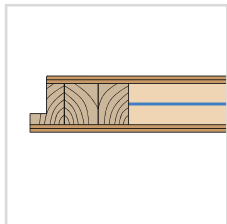

DOOR LEAF 46 mm reinforced with steel sheet



MULTIPOINT LOCK



SOUND INSULATION
38dB



FOUR 2-PIN HINGES; Ø16, 3D ADJUSTABLE



4 HINGE BOLTS



FIXED TIMBER in RC2 or reinforced frame in RC3



HARDWOOD THRESHOLD (lacquer)



FORTECA RC2



FORTECA RC3



MAGNETIC STOP, silver



DOOR VIEWER



STAINLESS STEEL THRESHOLD

FORTECA DOOR LEAF CROSS-SECTION

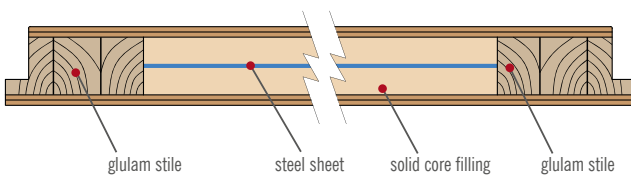

HARDWOOD THRESHOLD

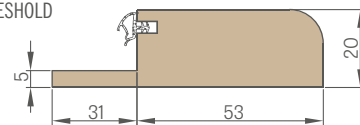

STAINLESS STEEL SHEET THRESHOLD

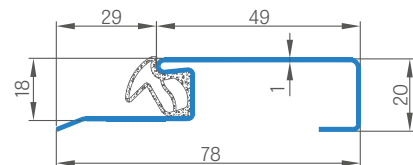



FORTECA RC2 & RC3

OPENING INWARDS/OUTWARDS RC2 & RC3 BURGLARPROOF REBATED DOORS



FORTECA RC2 & RC3 with OAK ST CPL facing



FORTECA RC2, NATUR OAK PREMIUM facing layer; anti-burglar RC2 handle, black matt

FORTECA RC 2		
GOLD PACKAGE	SILVER PACKAGE	DOOR LEAF

RC2 - Important:
For compliance with RC2 burglary resistance class as per the PN-EN 1627:2012, the hardware should meet the following requirements:

- Min Class 2 as per PN-EN 1906:2012 – for handles and door escutcheons
- Min Class 4 and 1 as per PN-EN 1303:2015 – for lock cylinders

FORTECA RC 3		
GOLD PACKAGE	SILVER PACKAGE	DOOR LEAF

RC3 - Important:
For compliance with RC3 burglary resistance class as per PN-EN 1627:2012, the hardware should meet the following requirements:

- Min Class 3 as per PN-EN 1906:2012 – for handles and door escutcheons
- Min Class 4 and 1 as per PN-EN 1303:2015 – for lock cylinders

GENERAL INFORMATION

- the FORTECA inwards/outwards opening burglar-proof doors are rated for sound insulation at $R_w=38$ dB, have a burglary resistance class of RC2 OR RC3 as per PN EN 1627:2012 and class 5 for mechanical durability
- available in the GOLD and SILVER packages with optional installation kit and steel door frame
- designed to be used as an internal front door.

CONSTRUCTION

- timber stile covered with glulam HDF boards
- specially designed solid core filling
- whole door leaf reinforced with a steel panel
- door leaf thickness of 46 mm

FINISHING

- leaf edge made in the STANDARD technology (with CPL 0.2 & 0.7 laminates, with the ABS edging in the same colour as the leaf only or with a standard black edge for an additional charge)
- insert (inlay) colour: brushed steel, black, brushed gold and OAK CLASSIC CPL with a width of 8 mm or 50 mm flush with the door leaf plane, made on both sides of the leaf, p. 86-91
- the edge faced with an edging in the same colour as the door leaf or, optionally plain black (transverse NATUR OAK PREMIUM, black edge with a transverse structure)
- HDF board faced with the GREKO, PREMIUM, CPL
- side and top panels glued to the wall (only for the door frame mounted on masonry and 8 cm clip-on square) – p. 148, and panels integrated with door frame – p. 149

HARDWARE

- four silver 2-pin hinges; $\varnothing 16$; 3D adjustable (2D with steel frame)
- four-point security hook bolt lock as standard for two lock cores
- four-hinge bolts on the hinge side
- possibility to apply an arm door closer
- lower lock PZ centre is 92 mm

FIXED REBATED DOOR FRAME

- fixed timber door frame covered with MDF boards; internally reinforced with a steel square on the door strike plates side for FORTECA RC3
- installation in the range of 90-450 mm every 40 mm
- adjustable main grip in the door frame and two adjustable grips for the bolt hook and additional lock

GOLD PACKAGE / GOLD black

- The GOLD PACKAGE FORTECA doors are complete with a steel or timber threshold, with a multipoint lock, and pre-drilled holes for a security handle and upper escutcheon. They come with a door viewer (opening by customer) and approved burglar-proof handles and cylinders in silver or, at an extra charge, black in the GOLD package with black finishing.

SILVER PACKAGE

- The SILVER PACKAGE FORTECA doors are complete with a steel or timber threshold, and a multipoint lock. We recommend ordering a door viewer and certified hardware from the ERKADO range or ordering the same from an external supplier keeping in mind the important note on compliance with the anti-burglary requirements (p. 110).

AVAILABLE DOOR LEAF WIDTHS

80N 80 90E 100

- GOLD PACKAGE / GOLD black door leaf with a fixed timber frame, stainless steel threshold and silver hardware or black hardware in GOLD package with black finish for extra charge**
- SILVER PACKAGE door leaf with fixed timber door frame, stainless steel threshold, w/o hardware**

EXTRA CHARGE

surcharge for GOLD package in black finish

- RC 2

- RC 3

"100" door

black door leaf edge finish

handle PZ centre of 92 mm with the upper escutcheon for RC 2 doors, silver F9 or black (Class 2 as per the PN-EN 1906:2012 standard)

handle with lock core protection and upper escutcheon for the RC3 door; F9 silver (Class 3 as per PN-EN 1906:2012)

two lock cores set (one with a thumbturn) in a master key system for RC2 and RC3 doors (Class 4 & 1 as per PN-EN 1303:2015)

door viewer

- nickel

- black

metal hinge casings: brushed nickel, patina, polished chrome, polished brass, white and black

cutting the door with the wooden frame by up to 8 cm and with steel frame by up to 6 cm in 1 cm increments

LUX inlay; available versions p. 86-91

arm door closer (silver; black, white, brown)

magnetic stop (buffer)

(available in six colours p. 145)

GREKO



PREMIUM

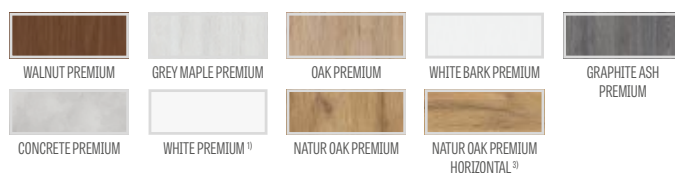

CPL

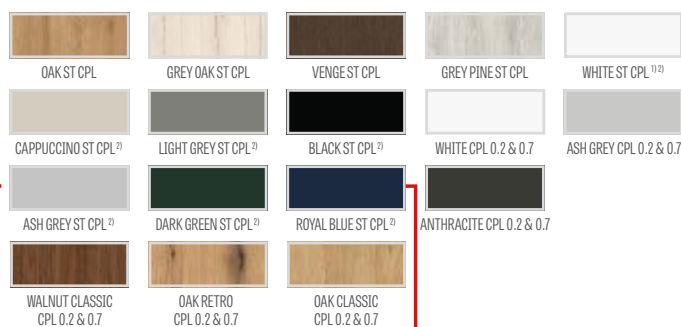

NEW

¹⁾ plain white facing imitating a painted surface

²⁾ special AntiFinger coating to reduce dirt and fingerprints

³⁾ comes complete with the NATUR OAK PREMIUM door frame



FIXED DOOR FRAME

FORTECA

FORTECA RC3 FIXED DOOR FRAME

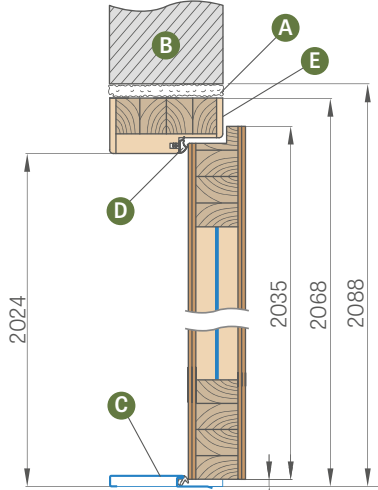

WALL CLADDING every 40 mm
(does not include a square with clips, which is charged extra)

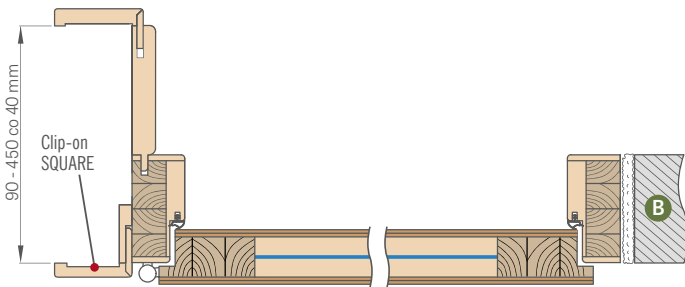

Range (mm)
90-130
130-170
170-210
210-250
250-290
290-330
330-370
370-410
410-450

The wall cladding is available with a 6 cm or 8 cm internal angle and with a choice of 6 cm or 8 cm external angle against an extra charge.

EXTRA CHARGES

frame joints at 90 degrees

clip-on square with 60 mm or 80 mm clips (the clip-on square with three clips extends the adjustment range by 20 mm)

cutting the door with the wooden frame to 8 cm in 1 cm increments

side and top panels available as glued to the wall and panels integrated with the frame (only for frames with cladding and 8 cm square)

headband and quarter round

- A - installation foam
- B - wall
- C - stainless steel or wooden threshold
- D - rubber gasket
- E - additional internal reinforcement in the frame with a steel square on the door strike plates side (only for the FORTECA RC3 door frame)

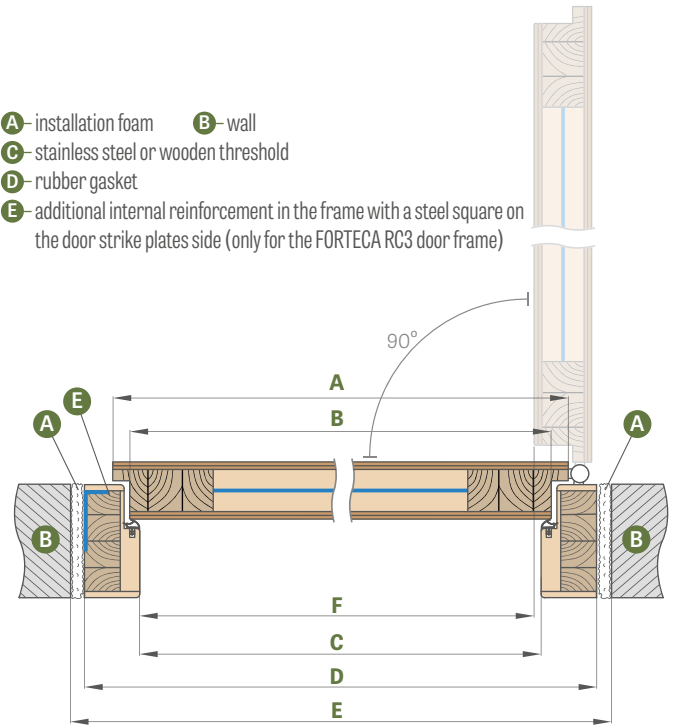

Door width	A	B	C	D	E	F
"80N"	804	778	764	852	892	759
"80"	848	822	808	896	936	803
"90E"	948	922	908	996	1036	903
"100"	1048	1022	1008	1096	1136	1003

"90E" - installation width

FIXED DOOR FRAME

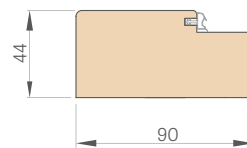

COVER PROFILE

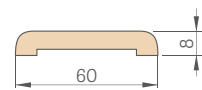

SQUARE 6 cm and 8 cm with clips

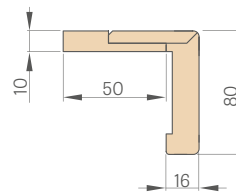

QUARTER ROUND

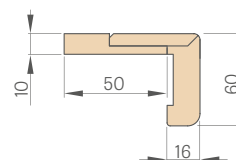
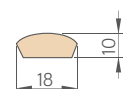



STEEL DOOR FRAMES

FORTECA

ADJUSTABLE STEEL DOOR FRAME (OVERLAPPING)

Welded and painted in RAL STANDARD and RAL ERKADO

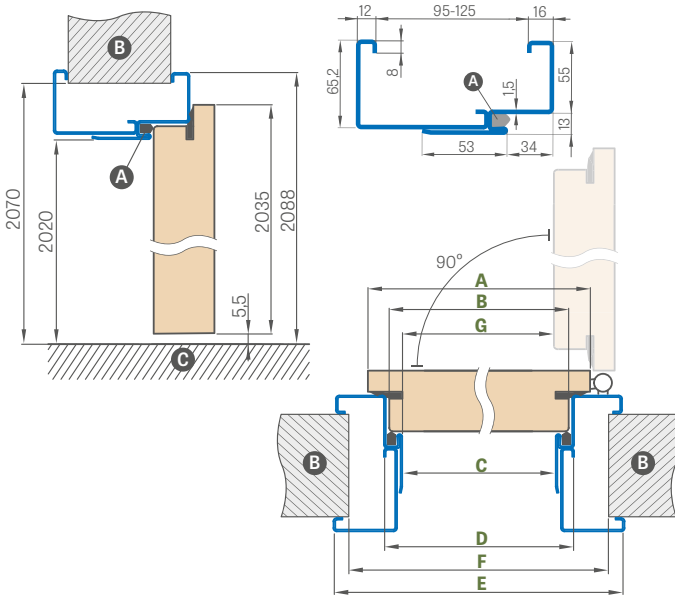

Door width	A	B	C	D	E	F	G
"80N"	804	778	761	787	897	865	754.5
"80"	848	822	805	831	941	910	798.5
"90ES"	960	934	917	943	1053	1022	910
"100" ¹⁾	1048	1022	1005	1031	1141	1110	998.5

¹⁾90ES" – installation width for a steel door frame

FORTECA RC2 ADJUSTABLE STEEL DOOR FRAME	
Adjustment range min-max (mm)	
95-125	
125-155	
155-185	
185-215	
215-245	
245-275	
275-305	
305-335	
335-365	

FORTECA RC3 ADJUSTABLE STEEL DOOR FRAME	
Adjustment range min-max (mm)	
95-125	
125-155	
155-185	
185-215	
215-245	
245-275	
275-305	
305-335	
335-365	

LARGE SQUARE STEEL FRAME

Welded and painted in RAL STANDARD and RAL ERKADO

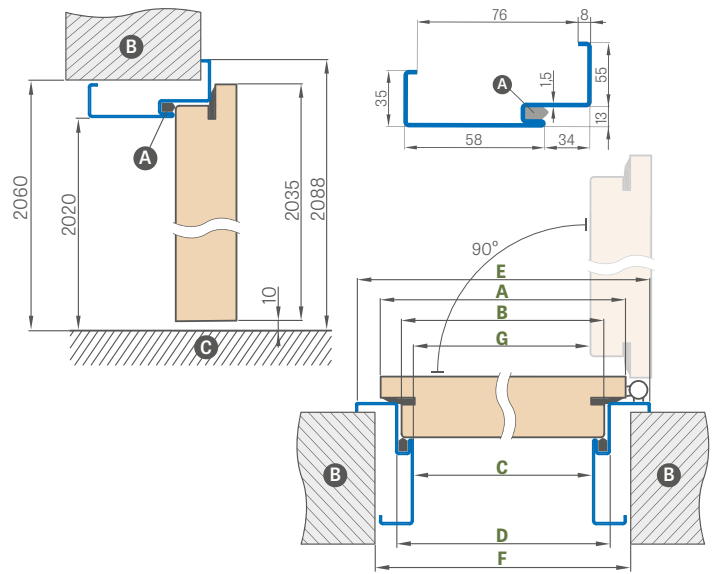

Door width	A	B	C	D	E	F	G
"80N"	804	778	761	787	897	840	754.5
"80"	848	822	805	831	941	885	798.5
"90ES"	960	934	917	943	1053	997	910
"100" ¹⁾	1048	1022	1005	1031	1141	1085	998.5

FITTING THE SQUARE FRAME

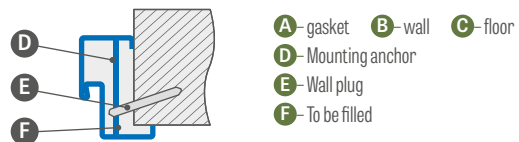

EXTRA CHARGES

"100" Square frame, large version

door closer reinforcement

stainless steel threshold

cutting the door with the steel frame to 6 cm in 1 cm increments

galvanised sheet steel

non-typical RAL (intensive, pearly and metallic colours not included)

RAL STANDARD



RAL ERKADO



NEW



HERSE SET EKO 30dB

HERSE SET AKUSTIC 39 dB HERSE SET 32 dB

FRONT DOORS WITH BURGLAR-PROOF LOCKS OR STRIP LOCKS



HERSE SET LUX 104 with integrated panel wall cladding in WALNUT CLASSIC CPL facing layer with ESSEN handle



UPPER SECURITY LOCK



LOWER SECURITY LOCK



ADJUSTABLE MAIN KEEPER IN FRAME



ESSEN HANDLE



HERSE SET AKUSTIC 39 dB DOOR, thickness 46 mm, reinforced with channel section and sheet steel



HERSE SET 32 dB DOOR, thickness 46 mm, reinforced with steel channel section



HERSE SET EKO 30 dB DOOR, thickness 46 mm, reinforced with steel channel section

HARDWOOD THRESHOLD

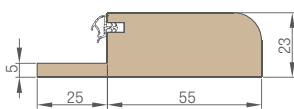

30_{dB} / 32_{dB} / 39_{dB}



THREE 2-PIN HINGES; Ø16, 3D ADJUSTABLE

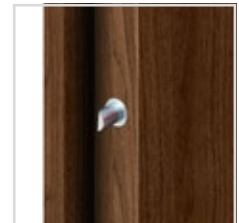

3 HINGE BOLTS



FIXED DOOR FRAME, wooden, for Rw=32dB and Rw=39 dB or MDF for Rw=30 dB



HARDWOOD THRESHOLD (lacquer)

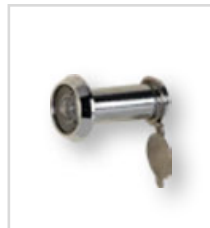

DOOR VIEWER



MAGNETIC STOP, silver



DROP DOWN SEAL with pressure adjustment



STAINLESS STEEL THRESHOLD

HERSE SET 32dB CROSS SECTION

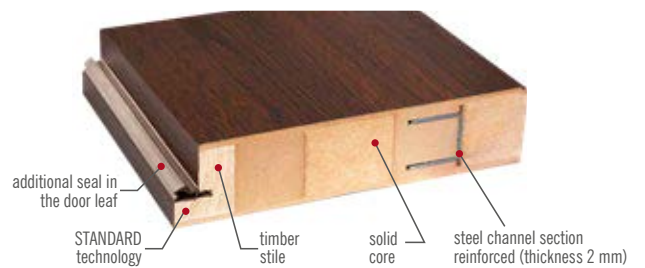

STAINLESS STEEL SHEET THRESHOLD

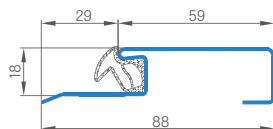



HERSE SET EKO 30dB

HERSE SET 32 dB HERSE SET AKUSTIC 39 dB

FRONT DOORS WITH BURGLAR-PROOF LOCKS OR STRIP LOCKS

HERSE SET with WALNUT CLASSIC CPL facing layer with ESSEN handle



GENERAL INFORMATION

- HERSE SET Doors are designed for housing and public utility building as an entrance internal door (excluding the "80N" width).
- The HERSE SET door leaf with fixed and adjustable door frame with each of thresholds available is rated for sound insulation at $R_w = 30\text{dB}$ or, for an additional charge, $R_w = 32\text{dB}$ and $R_w = 39\text{dB}$.
- HERSE SET Doors in GOLD and SILVER Packages are fully preassembled with a threshold fitted, and pre-drilled holes for handle and upper escutcheon installation for the GOLD version.

CONSTRUCTION

- timber frame for $R_w = 32\text{dB}$ and $R_w = 39\text{dB}$ or MDF for $R_w = 30\text{dB}$ covered with two HDF boards
- specially designed solid core filling
- robust steel channel section reinforcement $R_w = 30\text{dB}$ and $R_w = 32\text{dB}$ and additionally steel plate reinforcement for $R_w = 39\text{dB}$
- door leaf thickness of 46 mm
- additional seal in the door leaf only for $R_w = 32\text{dB}$ and $R_w = 39\text{dB}$

FINISHING

- door leaf edge made in the STANDARD technology
- CPL 0.2 & 0.7 laminates available only with the STANDARD edge with the ABS edging in the same colour as the door leaf only or, for an additional charge, with a standard black edge
- insert (inlay) colour: brushed steel, black, brushed gold, brushed copper and OAK CLASSIC CPL with a width of 8 mm or 50 mm flush with the door leaf plane, made on both sides of the leaf, p. 86-91
- STANDARD edge faced with an the same colour as the door leaf or, optionally, plain black edging (transverse NATUR OAK PREMIUM, black edge with a transverse structure)
- factory cut by up to 8 cm for an additional charge
- custom order with the lower lock only as an option
- side and top panels glued to the wall (only for the adjustable door frame with an 8 cm square) – p. 148, and panels integrated with door frame – p. 149

HARDWARE

- three silver 2-pin hinges; $\varnothing 16$; 3D adjustable (2D with a steel frame)
- two 3-pin Class 2 rated security locks with a thumb turn (optionally only lower)
- three hinge bolts on the hinge side
- possibility to apply an arm door closer
- lower lock PZ centre is 72 mm
- optionally, a bolt strip lock with two cores, against an extra charge

REBATED FIXED AND ADJUSTABLE DOOR FRAMES

- fixed door frame, wooden, for $R_w = 32\text{dB}$ and $R_w = 39\text{dB}$ or MDF for $R_w = 30\text{dB}$
- optionally, an electric door strike can be used in the door frame for the lower lock with no upper lock in the door leaf.
- adjustable main keeper in frames
- the 80N width is available for the fixed door frame only
- in GOLD and SILVER packages for PREMIUM and CPL decors the colour of the frame can be changed to BLACK ST CPL

HERSE SET EKO 30 dB

GOLD PACKAGE	SILVER PACKAGE	DOOR LEAF
--------------	----------------	-----------

AVAILABLE DOOR LEAF WIDTHS

80N	80	90E	100
-----	----	-----	-----

EDGE FINISH TYPES



GOLD PACKAGE Door leaf with fixed door frame, stainless steel threshold and hardware ¹⁾
SILVER PACKAGE Door leaf with fixed door frame, stainless steel threshold, w/o hardware ¹⁾

¹⁾ Hardware components: ESSEN handle in nickel satin, upper escutcheon, master key system lock cores (top with a thumbturn), door viewer (no pre-drilled hole) in silver or, at an extra charge, black

EXTRA CHARGES

GOLD package in black finish

door viewer, silver
door viewer, black

hardwood threshold (lacquer) for adjustable frames 55 mm or stainless steel threshold with gasket

hardwood threshold (lacquer) for adjustable frames

arm door closer (silver, black, white, brown)

door closer reinforcement

drop down seal ²⁾

cutting the door leaf with a wooden frame by up to 8 cm and with a steel frame by up to 6 cm in 1 cm increments in the CZ standard

black door leaf edge finish

"100" Door leaf or package

30/45 lock core

- silver

- black

30G/45 or 30/45G cylinder-holder, silver

30G/45 or 30/45G cylinder-holder, black

30/45 lock core and 30G/45 or 30/45G cylinder-holder in the master key system

- silver

- black

metal hinge casings: brushed nickel, patina, polished chrome, polished brass, white and black

ESSEN handle (nickel, satin, patina, black)

ESSEN upper escutcheon (nickel, satin, patina, black)

LUX inlay; available versions p. 86-91

additional charge for HERSE SET AKUSTIC 39 dB door

(added to the GOLD and SILVER packages or leaves)

additional charge for HERSE SET 32 dB door

(added to the GOLD and SILVER packages or leaves)

clip-on square, 3 pcs (extends the adjustment range by 20 mm)

magnetic stop (buffer) ²⁾

(available in six colours p. 145)

multi-point bolt strip lock with two locks

GREKO

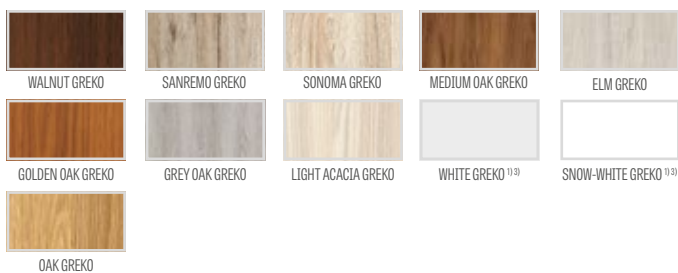

PREMIUM

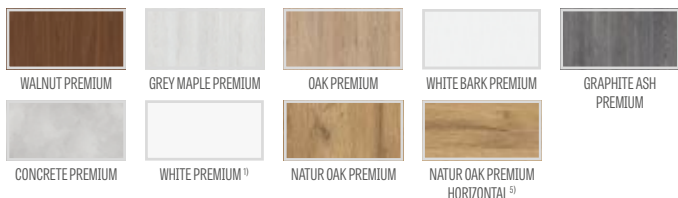

CPL

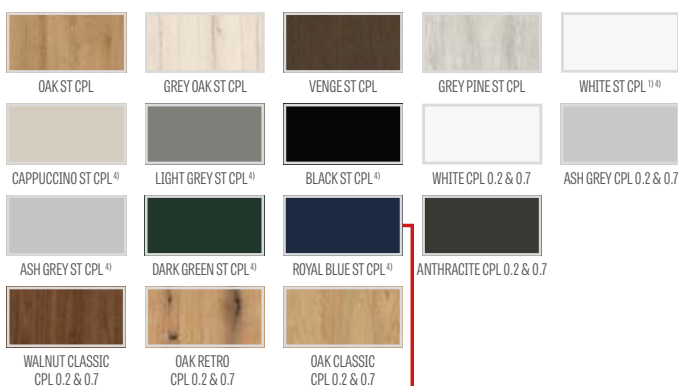

NEW

¹⁾ plain white facing imitating a painted surface

²⁾ a stop will not allow a drop down seal and an door undercut to be used, and vice versa

³⁾ available only in STANDARD

⁴⁾ special AntiFinger coating to reduce dirt and fingerprints

⁵⁾ comes complete with the NATUR OAK PREMIUM door frame

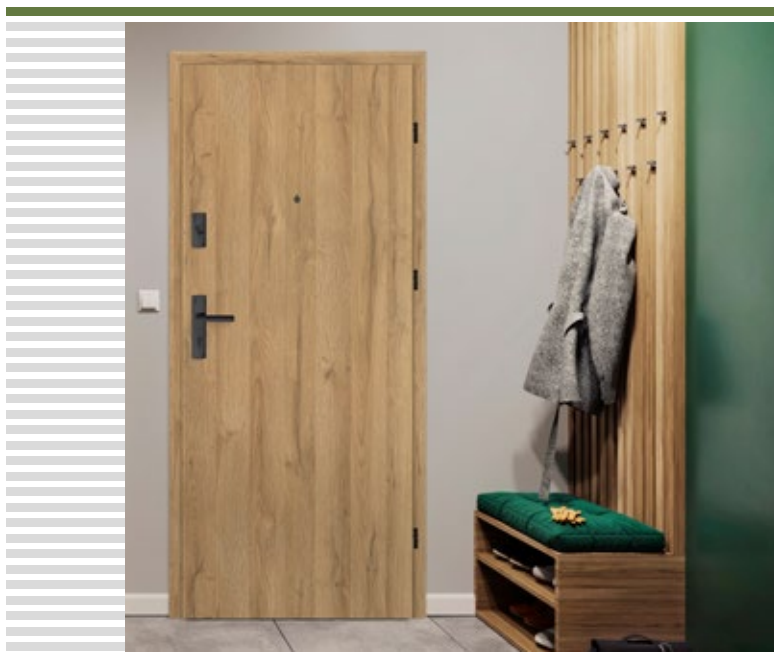

HERSE SET, the NATUR OAK PREMIUM facing, ESSEN handle. black



HERSE MAX SET EKO 30dB

HERSE MAX SET 32 dB HERSE MAX SET AKUSTIC 39 dB

FRONT DOORS WITH BURGLAR-PROOF LOCKS OR STRIP LOCKS

HERSE MAX SET 23 with OAK PREMIUM facing layer with ESSEN handle



GENERAL INFORMATION

- HERSE MAX SET Doors are designed for housing and public utility building as an entrance internal door (excluding the "80N" width).
- The HERSE MAX SET door leaf with fixed and adjustable door frame with each of thresholds available is rated for sound insulation at $R_w = 30\text{dB}$ or, for an additional charge, $R_w = 32\text{dB}$ and $R_w = 39\text{dB}$.
- HERSE MAX SET Doors in GOLD and SILVER Packages are complete with a threshold, and have pre-drilled holes for handle and upper escutcheon installation for the GOLD version.

CONSTRUCTION

- timber frame for $R_w = 32\text{dB}$ and $R_w = 39\text{dB}$ or MDF for $R_w = 30\text{dB}$ and covered with two HDF boards
- specially designed solid core filling
- robust steel channel section reinforcement $R_w = 30\text{dB}$ and $R_w = 32\text{dB}$ and additionally steel plate reinforcement for $R_w = 39\text{dB}$
- door leaf thickness of 46 mm
- additional seal in the door leaf only for $R_w = 32\text{dB}$ and $R_w = 39\text{dB}$

FINISHING

- STANDARD edge faced with an edging in the same colour as the door leaf or
- optionally, plain black edging (transverse NATUR OAK PREMIUM, black edge with a transverse structure)
- moulded HDF board covered with PREMIUM facing
- factory cut by up to 8 cm for an additional charge
- side and top panels glued to the wall (only for the adjustable door frame with an 8 cm square) – p. 148, and panels integrated with door frame – p. 149

HARDWARE

- three silver 2-pin hinges; $\varnothing 16$; 3D adjustable
- two 3-pin Class 2 rated security locks with a thumb turn (optionally only lower)
- three hinge bolts on the hinge side
- possibility to apply an arm door closer
- lower lock PZ centre is 72 mm
- optionally, a bolt strip lock with two cores, against an extra charge

REBATED FIXED AND ADJUSTABLE DOOR FRAMES

- fixed door frame, wooden, for $R_w = 32\text{dB}$ and $R_w = 39\text{dB}$ or MDF for $R_w = 30\text{dB}$
- optionally, an electric door strike can be used in the door frame for the lower lock with no upper lock in the door leaf.
- adjustable main keeper in frames
- the 80N width is available on the fixed door frame only
- in GOLD and SILVER packages for PREMIUM and CPL decors the colour of the frame can be changed to BLACK ST CPL

HERSE MAX SET EKO 30dB		
GOLD PACKAGE	SILVER PACKAGE	DOOR LEAF

PREMIUM

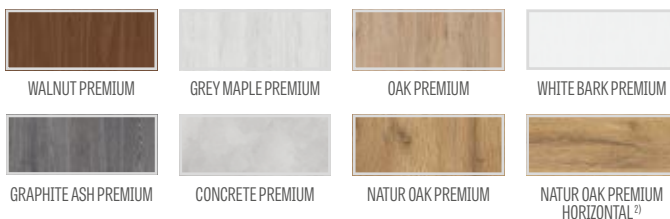

AVAILABLE DOOR LEAF WIDTHS

80N 80 90E 100

EDGE FINISH TYPES

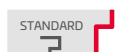

MOULDING

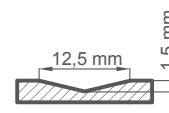

GOLD PACKAGE Door leaf with fixed door frame, stainless steel threshold and hardware¹⁾
SILVER PACKAGE Door leaf with fixed door frame, stainless steel threshold, w/o hardware¹⁾

¹⁾ hardware components: ESSEN handle in nickel satin, upper escutcheon, master key system lock cores (top with a thumbturn), door viewer (no pre-drilled hole) in silver or, at an extra charge, black

²⁾ comes complete with the NATUR OAK PREMIUM door frame

EXTRA CHARGES

GOLD package in black finish

door viewer, silver
door viewer, black

black door leaf edge finish

hardwood threshold (lacquer) for adjustable frames 55 mm or stainless steel threshold with gasket

hardwood threshold (lacquer) for adjustable frames

arm door closer (silver, black, white, brown)

door closer reinforcement

drop down seal ¹⁾

cutting the door leaf with a wooden frame by up to 8 cm and with a steel frame by up to 6 cm in 1 cm increments in the CZ standard

"100" door leaf or package

30/45 lock core

- silver
- black

30G/45 or 30/45G cylinder-holder, silver

30G/45 or 30/45G cylinder-holder, black

30/45 lock core and 30G/45 or 30/45G cylinder-holder in the master key system

- silver
- black

metal hinge casings: brushed nickel, patina, polished chrome, polished brass, white and black

ESSEN handle (nickel, satin, patina, black)

ESSEN upper escutcheon (nickel, satin, patina, black)

additional charge for HERSE MAX SET AKUSTIC39 dB (added to GOLD and SILVER packages or wing)

additional charge for HERSE MAX SET 32 dB door (added to the GOLD and SILVER packages or leaves)

clip-on square, 3 pcs (extends the adjustment range by 20 mm)

magnetic stop (buffer) ¹⁾
(available in six colours p. 145)

multi-point bolt strip lock with two locks



HERSE MAX SET 24



HERSE MAX SET 25



HERSE MAX SET 26



HERSE MAX SET 27



HERSE MAX SET 28



HERSE MAX SET 29



HERSE MAX SET 30



HERSE MAX SET 31

¹⁾ the stop prevents application of a drop down seal and vice versa



FIXED AND ADJUSTABLE FRAMES

HERSE SET, HERSE MAX SET

HERSE SET FIXED DOOR FRAME

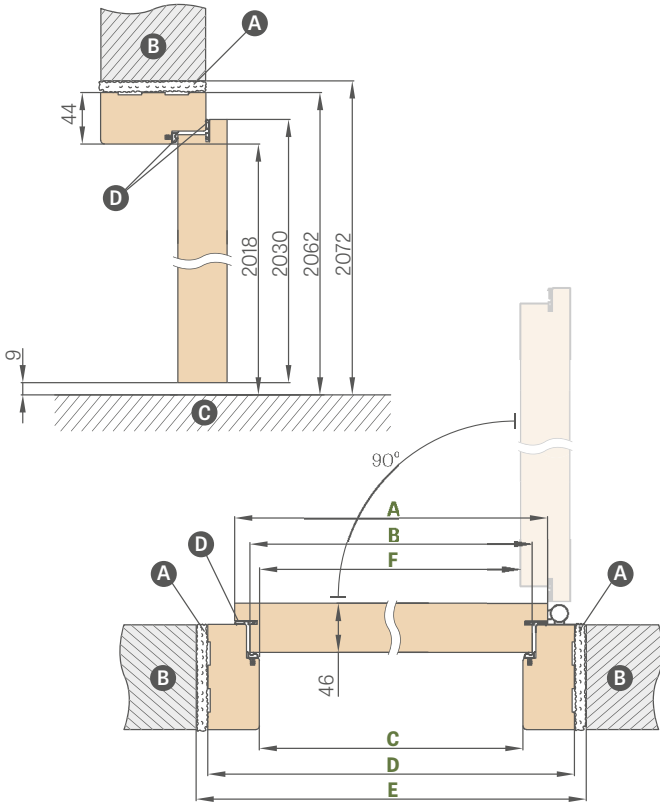

Door width	A	B	C	D	E	F
"80N"	804	777	764	852	872	756
"80"	844	817	804	892	912	796
"90E"	948	921	908	996	1016	900
"100"	1044	1017	1004	1092	1112	996

"90E" - installation width

HERSE SET ADJUSTABLE DOOR FRAME

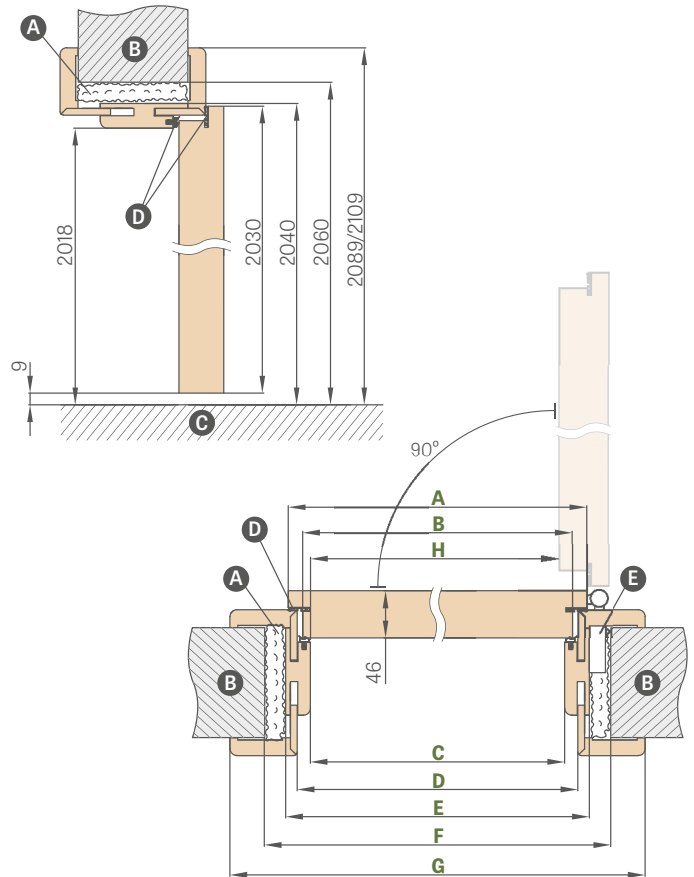

Door width	A	B	C	D	E	F	G	H
"80"	844	817	804	826	848	888	946*/986**	796
"90E"	948	921	908	930	952	992	1050*/1090**	900
"100"	1044	1017	1004	1026	1048	1088	1146*/1186**	996

* architrave 6 cm / ** architrave 8 cm

- A** - installation foam
- B** - wall
- C** - floor
- E** - hitching socket
- D** - gasket (for $R_w = 30\text{dB}$ in door frame only, for $R_w = 32\text{dB}$ and $R_w = 39\text{dB}$ both in frame and door)

ADJUSTABLE DOOR FRAME RANGE

architrave 6 cm / architrave 8 cm

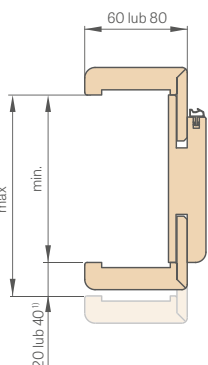

ADJUSTABLE TIMBER THRESHOLD

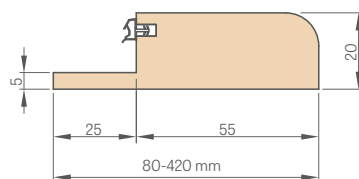

SQUARE:
6 cm and 8 cm.
Clip-on

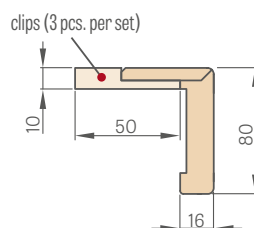

FIXED DOOR FRAME

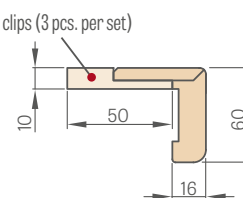
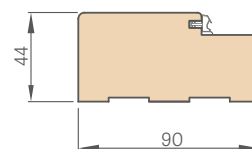

COVER PROFILE

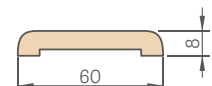

QUARTER ROUND

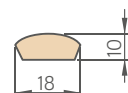

PRICES OF FIXED AND ADJUSTABLE DOOR FRAMES

HERSE SET, HERSE LUX SET & HERSE MAX SET Architraves 6 & 8 cm	
Adjustment Range min-max (mm)	
1 Component	80-100
	100-120
	120-140
	140-160
	160-180
	180-200
	200-220
	220-240
2 Components	240-260
	260-280
	280-320
	320-340
	340-360
	360-380
	380-400
	400-420

FIXED HARDWOOD THRESHOLD, COLOURLESS LACQUER 55 mm



- the fixed frame, architrave and clip-on square in CPL 0.2 are also used in the set for door leaves in CPL 0.7
- joints at 90 degrees of the adjustable frame possible with the 8 cm architraves only.
- additional charge for joining at 90 degrees
- electric door strike
- door closer reinforcement for adjustable door frame –
- square with three clips (square with clips extends the adjustment range by 20 mm)
- architrave and quarter round
- side and top panels glued to the wall available (only with an adjustable door frame and an 8 cm architrave)
- cutting the door (leaf and frame) by up to 8 cm every 1 cm or the product as per the CZ standard
- the hardwood door frame and threshold can be made up to the range of 500-520 mm – surcharge applies for every 2 cm, starting from the range of 400-420 mm



STEEL DOOR FRAMES

HERSE SET, HERSE MAX SET

HERSE SET ADJUSTABLE STEEL DOOR FRAME (OVERLAPPING)

Welded and painted in RAL STANDARD and RAL ERKADO

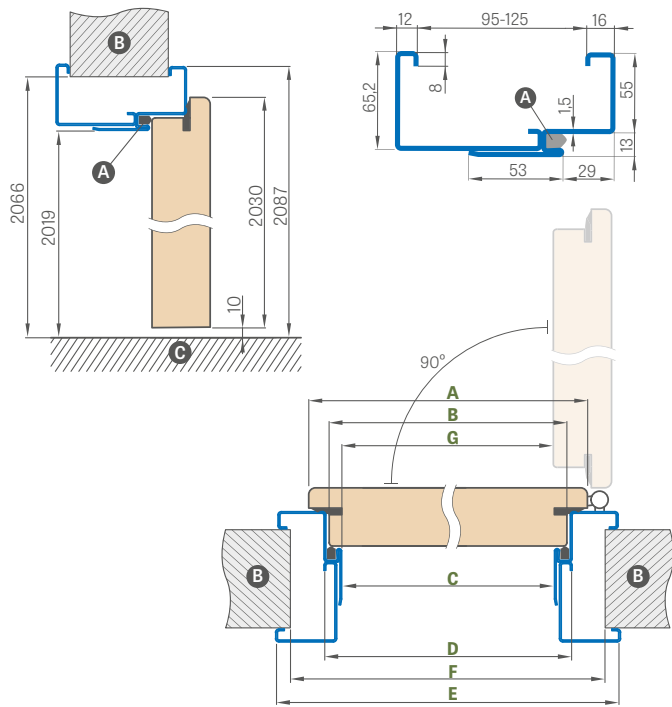

Door width	A	B	C	D	E	F	G
"80N"	804	777	761	787	897	855	756
"80"	844	817	801	827	937	895	796
"90ES"	948	921	905	931	1041	999	900
"100"	1044	1017	1001	1027	1137	1095	996

"90ES" - installation width for a steel door frame

Adjustment Range min-max (mm)
95-125
125-155
155-185
185-215
215-245
245-275
275-305

RAL STANDARD



RAL ERKADO



NEW

HERSE SET ADJUSTABLE SQUARE STEEL DOOR FRAME

Welded and painted in RAL STANDARD and RAL ERKADO

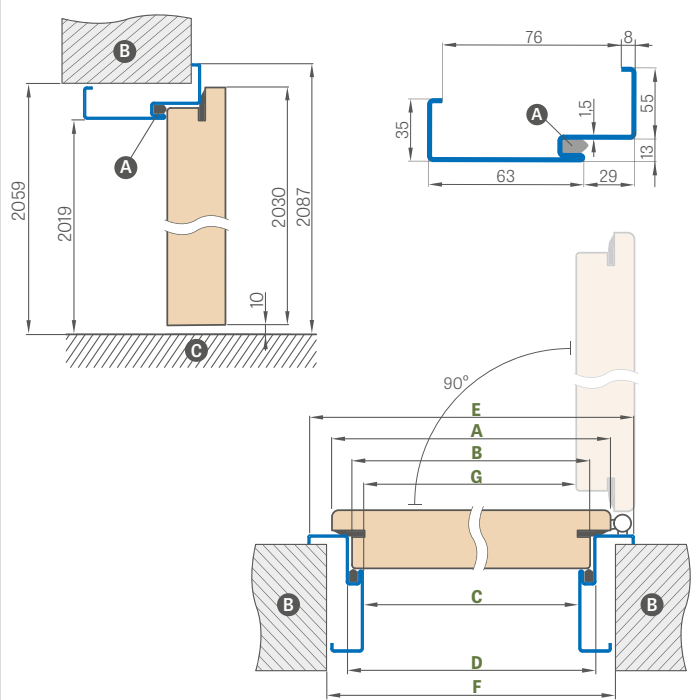

Door width	A	B	C	D	E	F	G
"80N"	804	777	761	787	897	841	756
"80"	844	817	801	827	937	881	796
"90ES"	948	921	905	931	1041	985	900
"100"	1044	1017	1001	1027	1137	1081	996

FITTING THE SQUARE FRAME

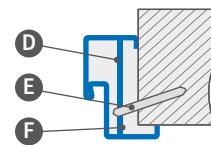

- A - gasket
- C - floor
- E - anchor bolt
- B - wall
- D - mounting anchor
- F - to be filled

EXTRA CHARGES

"100" Square frame, large version

electric door strike

door closer reinforcement

cutting the door with the steel frame by up to 6 cm in 1 cm increments

stainless steel threshold

galvanised sheet steel

non-typical RAL (intensive, pearly and metallic colours not included)



UNITED STEEL DOOR FRAME

HERSE SET, HERSE MAX SET

UNITED STEEL DOOR FRAME DIAGRAM

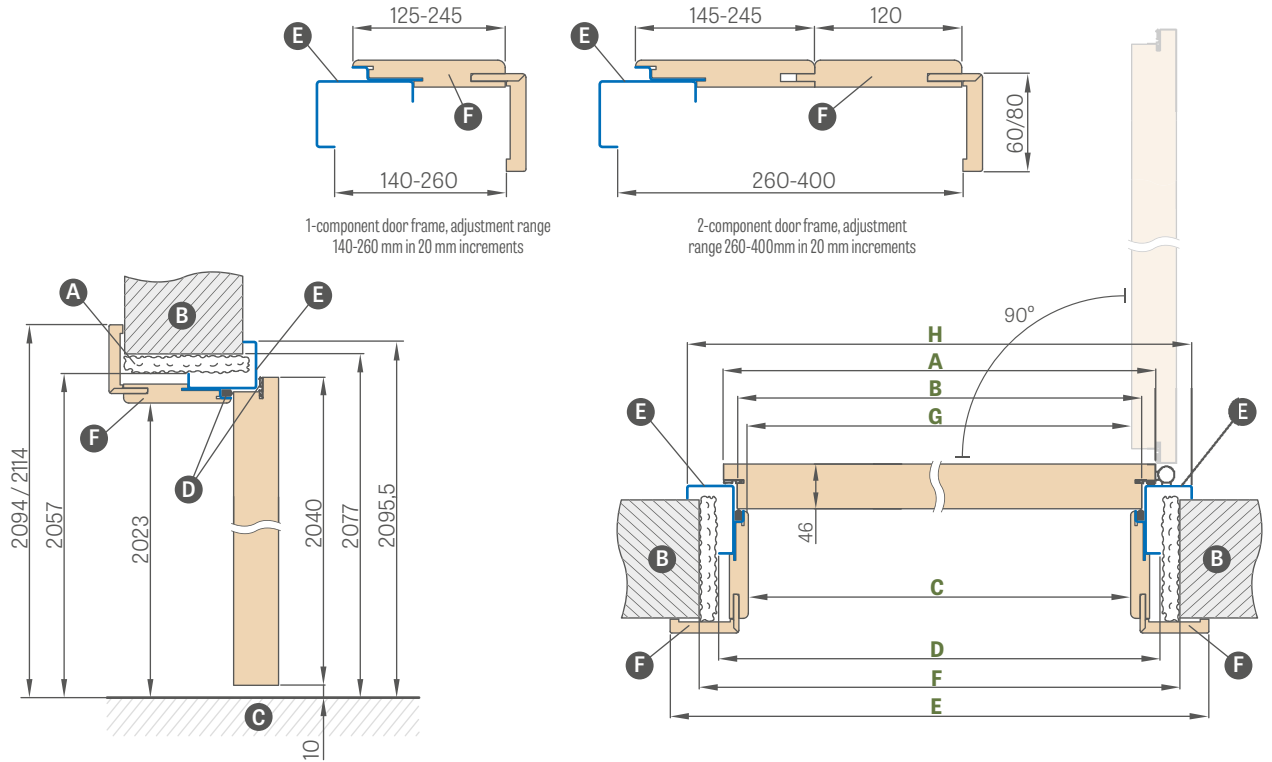

Door width	A	B	C	D	E	F	G	H
"80U"	844	817	791.5	859	933.5/973.5	899	790	935
"90EU"	960	933	907.5	975	1049.5/1089.5	1015	906	1051
"100U"	1044	1017	991.5	1059	1133.5/1173.5	1099	990	1135

*90EU" – installation width for the UNITED steel door frame

- A** – installation foam
- B** – wall
- C** – floor
- D** – rubber gasket
- E** – steel part painted in RAL colour
- F** – MDF part with laminate/foil

EXTRA CHARGES

- electric door strike
- door closer reinforcement
- cutting the door with a UNITED steel door frame by up to 6 cm in 1 cm increments
- stainless steel threshold, height: 20 mm
- galvanised sheet steel
- non-typical RAL (intensive, pearly and metallic colours not included)

Adjustment Range min-max (mm)	
1 component	140-160
	160-180
	180-200
	200-220
	220-240
	240-260
2 Components	260-280
	280-300
	300-320
	320-340
	340-360
	360-380
	380-400

RAL STANDARD

RAL 9003	RAL 9010	RAL 9016	RAL 8003	RAL 8017	RAL 7016	RAL 7022	RAL 9005	RAL 7047	RAL 1001

RAL ERKADO

CAPPUCCINO	LIGHT GREY	DARK GREEN	ROYAL BLUE	ASHY	ANTHRACITE	BLACK

NEW



LEDA EI30, EI60

FIRE INTERNAL FRONT DOORS MADE IN HALSPAN TECHNOLOGY



ADJUSTABLE STEEL DOOR FRAME (OVERLAPPING)

Adjustment Range min-max (mm)
95-125
125-155
155-185
185-215
215-245
245-275
275-305

GREKO

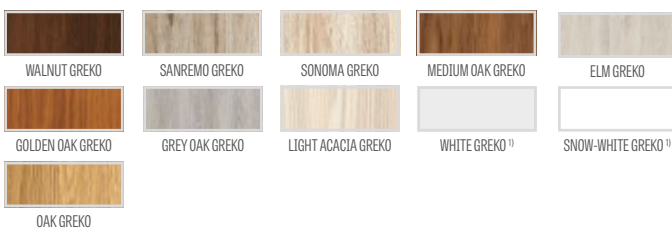

PREMIUM

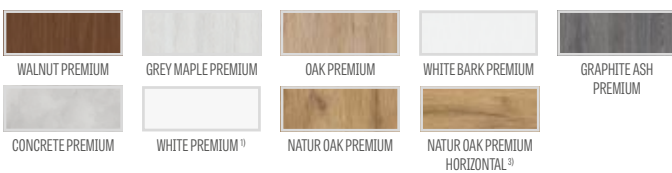

CPL

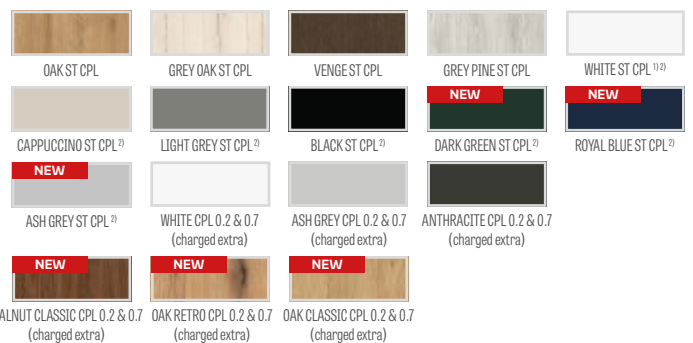

1) plain white facing imitating a painted surface
 2) special AntiFinger coating to reduce dirt and fingerprints
 3) comes complete with the NATUR OAK PREMIUM door frame

GENERAL INFORMATION

Fire protection, smoke control and sound insulation are ensured only when a complete doorset is installed, including a fire door leaf (with gaskets, lock, hinges and drop down seal pre-assembled), door frame, door closer, as well as a lock core and handle in compliance with the Polish Standard.

The sound insulation of the HALSPAN door system supplied with a drop down seal as per PN-B-02151-03:1999 is rated at $R_w=32$ dB

The door leaves are marketed complete with a timber or steel door frame only.

CONSTRUCTION

- filled with a special HALSPAN board with a thickness of 44 mm for Type EI30 and 54 mm for EI60
- overall door leaf thickness 50 mm in EI30 and 60 mm in EI60
- softwood door frame
- fire rated and smoke intumescent door gasket
- drop down seal
- transparent fire-resistant glass; the glass width is fixed (not dependent on) the door leaf width

FINISHING

- leaf edge made in the STANDARD technology (with CPL 0.2 & 0.7 laminates, with the ABS edging in the same colour as the leaf only or with a standard black edge for an additional charge)
- 8 mm or 50 mm wide brushed steel, brushed gold, black or OAK CLASSIC CPL inlays flush with the door leaf, on both leaf sides. Applies to LEDA full only. Inlay types shown on pages 86-91
- two-sided inlays only in full leaf and on only on the active leaf in double doors
- the edge faced with an edging in the same colour as the door leaf or, optionally plain black (transverse NATUR OAK PREMIUM, black edge with a transverse structure)
- Side and top panels glued to the wall (only when fitted with an 8 cm square) – page 148

HARDWARE

- four hinges; $\varnothing 16$; 3D adjustable (2D for the steel frame)
- thumb turn cylinder lock
- door closer for an additional charge

DOOR FRAMES

- fire rated fixed door frame
- fire rated gasket
- adjustable door strike plate
- adjustable steel, square large or welded frames in RAL 9010, 8003, 8017, 7035, 7016, 1005
- fixed frame made of black sheet metal, thickness 1.5 mm, RAL powder painted, welded in the corners, fitted with a fire rated gasket and door closer reinforcement as standard.

EXTRA CHARGES

fire rated arm door closer in colours: silver, black, white, brown

fire rated cam-action door closer (only for frames with or without housing with a clip-on square) in colours: silver, black, white, brown

fire rated ventilation grille

JOWISZ INOX handle, backplate, euro profile, see p. 140

30/40 lock core (EI30) or 30/50 (EI60)

fire-proof door viewer, satin, chrome

metallic hinge casings (matt chrome, black)

fire rated lever tumbler lock, top mounting

black door leaf edge finish

Housing for EI30 from 100 to 460 and
Housing for EI60 from 120 to 480 every 40 mm
Double door housing

fire rated electric door strike
(standard) 12/24V (not for the steel door frame)

steel door frame in RAL not in the range (intensive, pearl and metallic colours not included)

steel door frame made of galvanised sheet steel

LUX INLAY: available versions p. 86-91
(on both sides on a full door leaf, and on an active double only)

CPL 0.2 laminate (for doors w/o housing)

CPL 0.7 laminate (for doors w/o housing)

clip-on square ¹⁾
(The clip-on square extends the adjustment range by 20 mm)

additional charge for the "110" leaf

side and top panels glued to the wall available (only with a wall installed door frame and an 8 cm square)

¹⁾ In the version with housing, the clip-on square is included



LEDA EI30, EI60

SINGLE DOOR

FIXED WOODEN DOOR FRAME

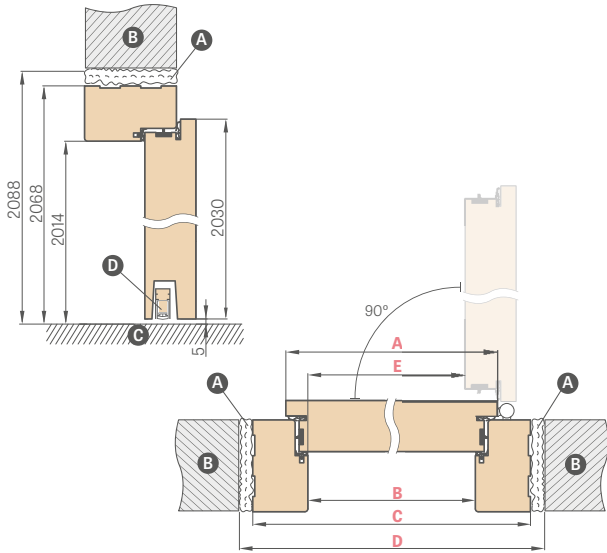

Door width	A	B	C	D	E
"80"	860	817	925	955	805
"90E"	960	917	1025	1055	905
"100"	1060	1017	1125	1155	1005
"110"	1160	1117	1225	1255	1105

- A** fire-resistant installation foam
- B** wall
- C** floor
- D** drop down seal

"90E" - installation width

FIRE RATED DOOR FRAME CROSS-SECTION IN MASONRY AND WITH CLIP-ON SQUARE

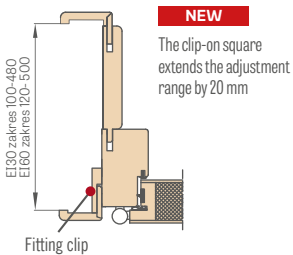

FIRE RATED DOOR FRAME CROSS-SECTION IN BASIC MASONRY

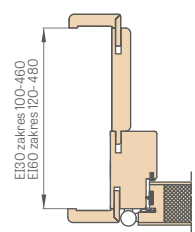

CLIP-ON SQUARE, 6 cm and 8 cm with clips

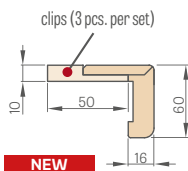
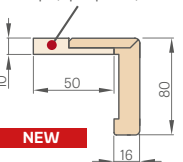

FIRE RATED FIXED DOOR FRAME CROSS-SECTION

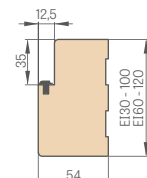

CAM-ACTION DOOR CLOSER 1)



ARM DOOR CLOSER



ADJUSTABLE STEEL FIRE DOOR FRAME (OVERLAPPING)

Welded and coated in RAL 9003, 9010, 9016, 8003, 8017, 7016, 7022, 7047, 1001

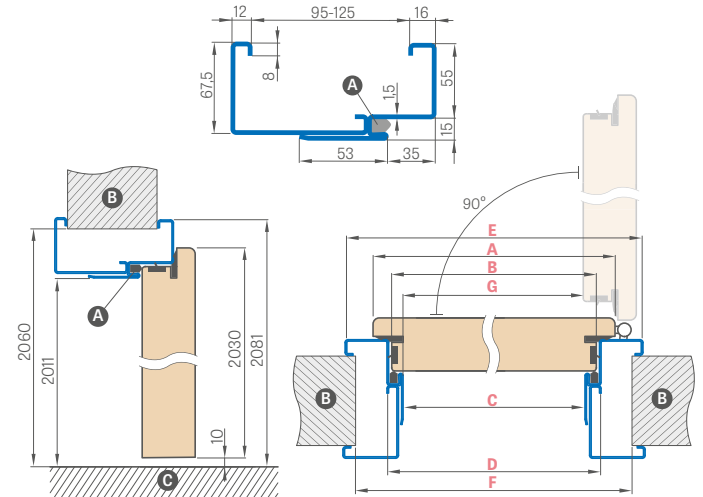

Door width	A	B	C	D	E	F	G
"80"	860	834	813	843	953	910	802
"90ES"	960	934	913	943	1053	1010	902
"100"	1060	1034	1013	1043	1153	1110	1002
"110"	1160	1134	1113	1143	1253	1210	1102

"90ES" - installation width for a steel door frame

LARGE STEEL FIRE SQUARE DOOR FRAME (OVERLAPPING)

Welded and coated in RAL 9003, 9010, 9016, 8003, 8017, 7016, 7022, 7047, 1001

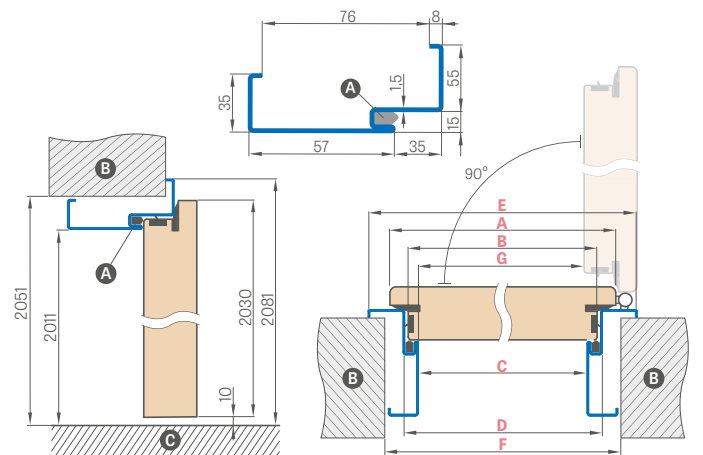

Door width	A	B	C	D	E	F	G
"80"	860	834	813	843	953	890	802
"90ES"	960	934	913	943	1053	990	902
"100"	1060	1034	1013	1043	1153	1090	1002
"110"	1160	1134	1113	1143	1253	1190	1102

RAL STANDARD



RAL 9003²⁾ RAL 9010 RAL 9016 RAL 8003 RAL 8017 RAL 7016 RAL 7022²⁾ RAL 7047 RAL 1001

¹⁾ use the cam-action door closer for a fixed door frame only or for frames with a clip-on square

²⁾ additional charge +10%



LEDA EI30, EI60

DOUBLE DOORS

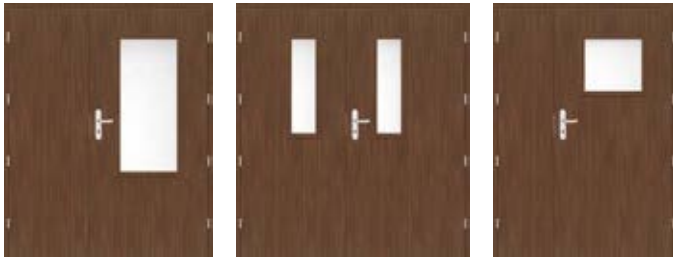

LEDA 3 "90E" + passive "60" door leaf

LEDA 6 "90E" + passive "80" door leaf

LEDA 4 "90E" + "40" side panel

AVAILABLE ACTIVE DOOR LEAF WIDTHS FOR DIFFERENT FIRE DOOR TYPES

LEDA EL30 EL60 80 90E 100	LEDA Type 3 glazing EL30 90E 100	LEDA Type 4 glazing EL30 EL60 90E 100	LEDA Type 5 glazing EL30 80 90E 100
LEDA Type 6 glazing EL30 EL60 80 90E 100	LEDA Type 7 glazing EL30 80 90E 100	LEDA Type 8 glazing EL30 EL60 80 90E 100	

AVAILABLE PASSIVE DOOR LEAF WIDTHS FOR DIFFERENT FIRE DOOR TYPES

LEDA EL30 EL60 60 70 80	LEDA Type 5 glazing EL30 70 80	LEDA Type 6 glazing EL30 EL60 70 80
LEDA Type 7 glazing EL30 70 80	LEDA Type 8 glazing EL30 EL60 70 80	

LEDA EI30 & EI60 DOUBLE DOORS

- the double doors are made within the LEDA EI30 and EI60 ranges with prices depending on the colour and finish (STANDARD);
- the passive leaf is made in two versions:
 - solid core for widths: "60", "70", "80"
 - glazed in types 5, 6, 7, 8 for EI30 and glazed in types 6 and 8 for EI 60
- side panel for the widths of "30", "40" and "50", all of which are solid core, plain doors;
- the passive leaf and side panel are supplied with shootbolt locks and bolt keepers; w/o lippings.

DOUBLE DOOR PRICE

- The price includes
- active part = price of full single door; plus possible extra charges as for single doors
 - passive part = price for the solid version (also side panel), plus possible extra charges as for single doors

AVAILABLE DOOR LEAF WIDTHS

active leaf **80 90E 100** + passive leaf **60 70 80**
 active leaf **80 90E 100** + solid core, plain side panel **30 40 50**

	DOUBLE FIRE DOOR TIMBER DOOR FRAME								
	"110"	"120"	"130"	"140"	"150"	"160"	"170"	"180"	
A Active door leaf width	860	860 960	860 960 1060	860 960 1060	860 960 1060	860 960 1060	960 1060	1060	
B Passive door leaf/Side panel widths	347	447 347	547 447 347	647 547 447	747 647 547	847 747 647	847 747	847	
C Frame opening width	1170	1270	1370	1470	1570	1670	1770	1870	
F Frame outer width	1278	1378	1478	1578	1678	1778	1878	1978	
E Opening width in the wall	1310	1410	1510	1610	1710	1810	1910	2010	

ADJUSTABLE STEEL FIRE DOOR FRAME (OVERLAPPING)

Welded and coated in RAL 9010, 9016, 8003, 8017, 7016, 7047, 1001

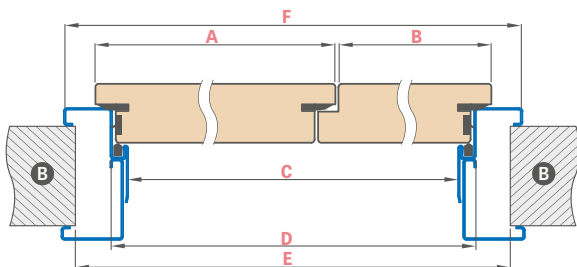

LARGE STEEL FIRE SQUARE DOOR FRAME (OVERLAPPING)

Welded and coated in RAL 9010, 9016, 8003, 8017, 7016, 7047, 1001

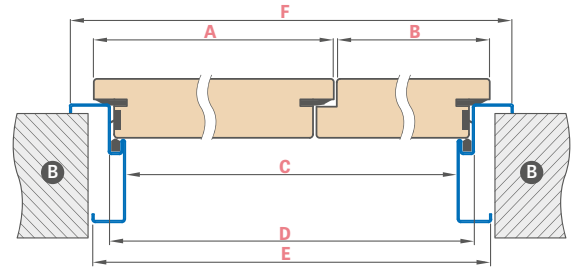

Door width	A	B	C	D	E	F
"110"	860	347	1166	1196	1270	1306
"120"	860 960	447 347	1266	1296	1370	1406
"130"	860 960 1060	547 447 347	1366	1396	1470	1506
"140"	860 960 1060	647 547 447	1466	1496	1570	1606
"150"	860 960 1060	747 647 547	1566	1596	1670	1706
"160"	860 960 1060	847 747 647	1666	1696	1770	1806
"170"	960 1060	847 747	1766	1796	1870	1906
"180"	1060	847	1866	1896	1970	2006

Door Width	A	B	C	D	E	F
"110"	860	347	1166	1196	1236	1306
"120"	860 960	447 347	1266	1296	1336	1406
"130"	860 960 1060	547 447 347	1366	1396	1436	1506
"140"	860 960 1060	647 547 447	1466	1496	1536	1606
"150"	860 960 1060	747 647 547	1566	1596	1636	1706
"160"	860 960 1060	847 747 647	1666	1696	1736	1806
"170"	960 1060	847 747	1766	1796	1836	1906
"180"	1060	847	1866	1896	1936	2006



HYPERION E130 RC2 39dB

INTERNAL FRONT FIRE AND BURGLAR-PROOF DOORS MADE IN THE ERKADO TECHNOLOGY



HYPERION in OAK CLASSIC CPL facing layer with BONN handle, black matt, inlay, LUX 213

AVAILABLE DOOR LEAF WIDTHS

80 90E 100

RC2 - Important:

For compliance with RC2 burglary resistance class as per the PN-EN 1627:2012, the hardware should meet the following requirements:

- min Class 2 as per PN-EN 1906:2012 – for handles and door escutcheons
- min Class 4 and 1 as per PN-EN 1303:2015 – for lock cylinders

GREKO

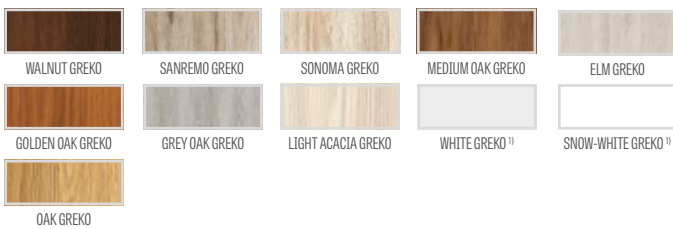

PREMIUM

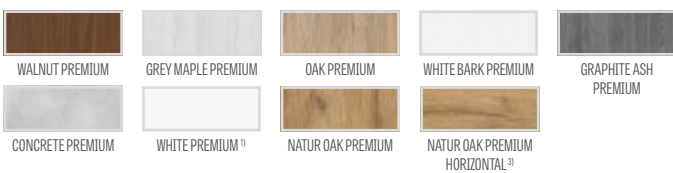

CPL

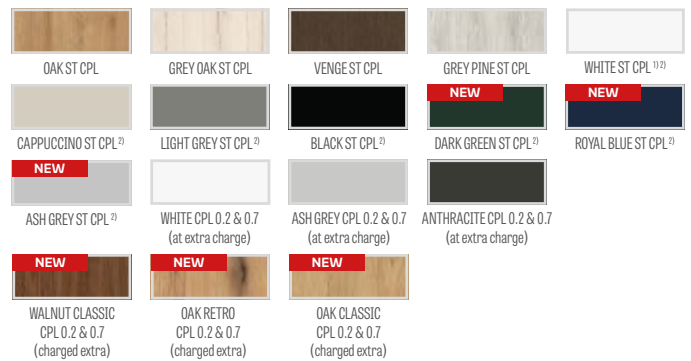

¹⁾ plain white facing imitating a painted surface

²⁾ special **AntiFinger** **NEW** coating to reduce dirt and fingerprints

³⁾ comes complete with the NATUR OAK PREMIUM door frame

GENERAL INFORMATION

Fire protection, smoke control and sound insulation are ensured only when a complete doorset is installed, including a fire door leaf (with gaskets, lock, hinges and drop down seal pre-assembled), door frame, door closer, as well as a lock core and handle in compliance with the Polish Standard.

The sound insulation of the door with a drop down seal as per N-B-02151-03:1999 is rated at $R_w=39$ dB

The door leaves are sold complete with a wooden door frame only.

The doors have an anti-burglary RC2 certificate for inward opening doors.

CONSTRUCTION

- special 44 mm thick filling
- total door leaf thickness of 50 mm
- softwood door frame
- fire rated and smoke intumescent door gasket
- drop down seal

FINISHING

- leaf edge made in the STANDARD technology (with CPL 0.2 & 0.7 laminates, with the ABS edging in the same colour as the leaf only or with a standard black edge for an additional charge)
- insert (inlay) colour: brushed steel, black, brushed gold and OAK CLASSIC CPL with a width of 8 mm or 50 mm flush with the door leaf plane, made on both sides of the leaf, p. 86-91
- the edge faced with an edging in the same colour as the door leaf or, optionally plain black (transverse NATUR OAK PREMIUM, black edge with a transverse structure)
- Side and top panels glued to the wall (only when fitted with an 8 cm square) – page 148

HARDWARE

- four hinges; $\varnothing 16$; 3D adjustable
- multi-point bolt strip lock with two locks
- door closer for an additional charge

DOOR FRAMES

- fixed wooden fire protection door frame optionally with cladding
- fire rated gasket
- adjustable door strike plate

FIRE RATED DOOR FRAME CROSS-SECTION IN MASONRY AND WITH CLIP-ON SQUARE

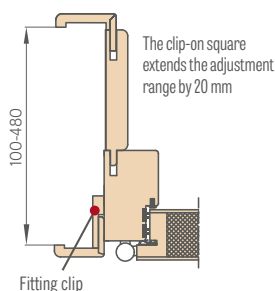

FIRE RATED DOOR FRAME CROSS-SECTION IN BASIC MASONRY

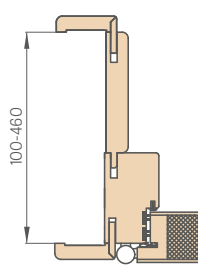

CAM-ACTION DOOR CLOSER ²⁾
(silver, black, white, brown)



ARM DOOR CLOSER
(silver, black, white, brown)



¹⁾ in the version with housing, the clip-on square is included

²⁾ use the cam-action door closer for a fixed door frame only or for frames with a clip-on square

EXTRA CHARGES

fire rated arm door closer in colours: silver, black, white, brown

fire rated cam-action door closer (only for frames with or without housing with a clip-on square) in colours: silver, black, white, brown

BONN handle, long escutcheon, lock core, see p. 140

BONN escutcheon (page 140)

metallic hinge casings (matt chrome, black)

two silver lock cores set (one with a thumbturn) in a master key system for RC2 doors (class 4 & 1 as per PN-EN 1303:2015)

– silver

– black

fire-proof door viewer, satin, chrome

black door leaf edge finish

cladding for EI30 from 100 to 480 mm

LUX inlay; available versions p. 86-91

CPL 0.2 laminate (for doors w/o housing)

CPL 0.7 laminate (for doors w/o housing)

clip-on square ¹⁾ (the clip-on square extends the adjustment range by 20 mm)

side and top panels glued to the wall available (only with a wall installed door frame and an 8 cm square)

FIXED WOODEN DOOR FRAME

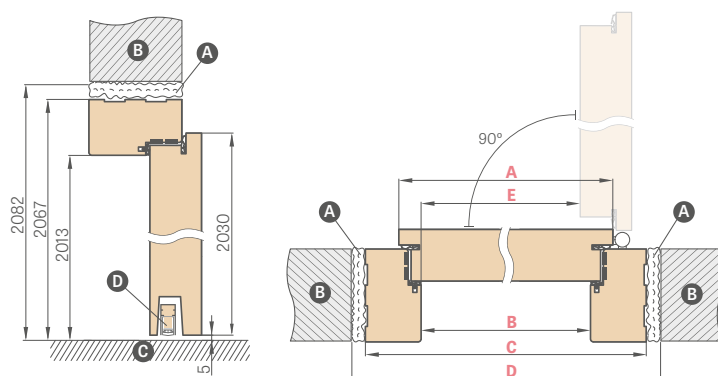

Door width	A	B	C	D	E
"80"	860	817	925	955	805
"90E"	960	917	1025	1055	905
"100"	1060	1017	1125	1155	1005

"90E" – installation width

A fireproofing foam **B** masonry **C** floor **D** drop gasket

CLIP-ON SQUARE, 6 cm and 8 cm with clips

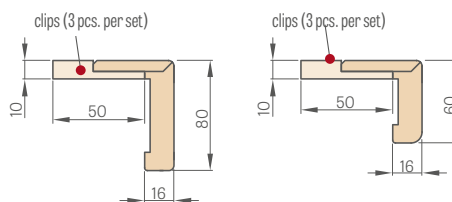

FIRE RATED FIXED DOOR FRAME CROSS-SECTION

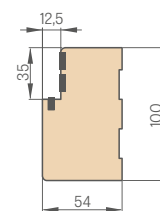



HARDWARE

HANDLES FOR FLUSH AND PANELLED DOORS

The handle cannot be used for flush doors with casing frames, see p. 174



NEW

CORONA TIME SLIM R handle

brass matt, gunmetal, black matt



brass matt



gunmetal



black matt



HANDLE CLASS
PREMIUM

NEW

CORONA IMPERA RT handle

glossy chrome, brushed matt chrome, glossy copper, brushed matt nickel, black matt, white matt



glossy chrome



brushed matt chrome



shiny copper



brushed matt nickel



black matt



white matt



HANDLE CLASS
PREMIUM

HANDLES FOR FLUSH AND PANELLED DOORS
 The handle cannot be used for flush doors with casing frames, see p. 174



NEW

CORONA ARROW R handle

glossy chrome, brushed matt chrome, white matt, black matt



glossy chrome



brushed matt chrome



black matt



white matt

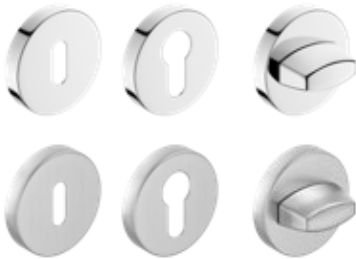

NEW

CORONA ARROW Q handle

glossy chrome, brushed matt chrome, white matt, black matt



glossy chrome



brushed matt chrome



black matt



white matt



NEW

CORONA MOON R SLIM handle

glossy chrome, black matt, glossy brass, brass matt



glossy chrome



black matt



glossy brass



brass matt



HANDLES FOR FLUSH AND PANELLED DOORS

The handle cannot be used for flush doors with casing frames, see p. 174

NEW

METAL-BUD QUANTA FIT handle (prestige 6 mm thick escutcheon)

glossy chrome, brushed nickel, brushed brass, black matt

Metal-Bud

PRODUCENT KLAMEK



glossy chrome



brushed nickel



brushed brass



black matt

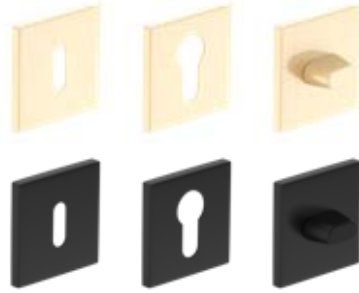

METAL-BUD BELLA SLIM SQUARE handle (prestige 6 mm thick escutcheon)

glossy chrome, brushed matt chrome, glossy brass, black matt

Metal-Bud

PRODUCENT KLAMEK



glossy chrome



brushed matt chrome



glossy brass



brass satin



black matt

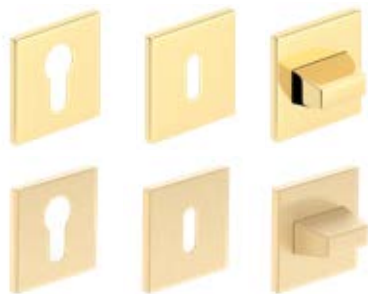
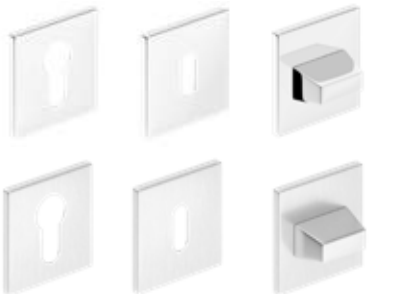

HANDLE CLASS
PREMIUM

METAL-BUD BELLA SLIM ROUND handle (prestige 6 mm thick escutcheon)

glossy chrome, brushed matt chrome, glossy brass, black matt

Metal-Bud

PRODUCENT KLAMEK



glossy chrome



brushed matt chrome



glossy brass



brass satin



black matt

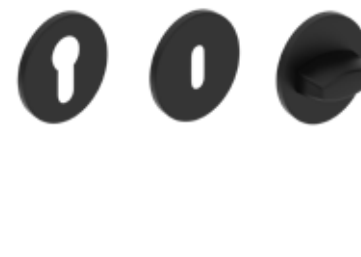
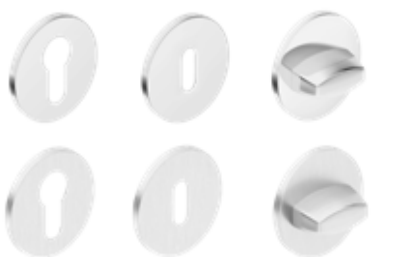

HANDLE CLASS
PREMIUM

HANDLES FOR FLUSH AND PANELLED DOORS

The handle cannot be used for flush doors with casing frames, see p. 174

METAL-BUD CUBE SLIM handle (prestige 6 mm thick escutcheon)

glossy chrome, brushed matt chrome, glossy brass, black matt

Metal-Bud

PRODUCENT KLAMEK



glossy chrome

brushed matt chrome

glossy brass

brass satin

black matt



HANDLE CLASS
PREMIUM

METAL-BUD CUBE handle

glossy chrome, brushed matt chrome, brushed matt nickel, black matt

Metal-Bud

PRODUCENT KLAMEK



glossy chrome

brushed matt chrome

brushed matt nickel

black matt

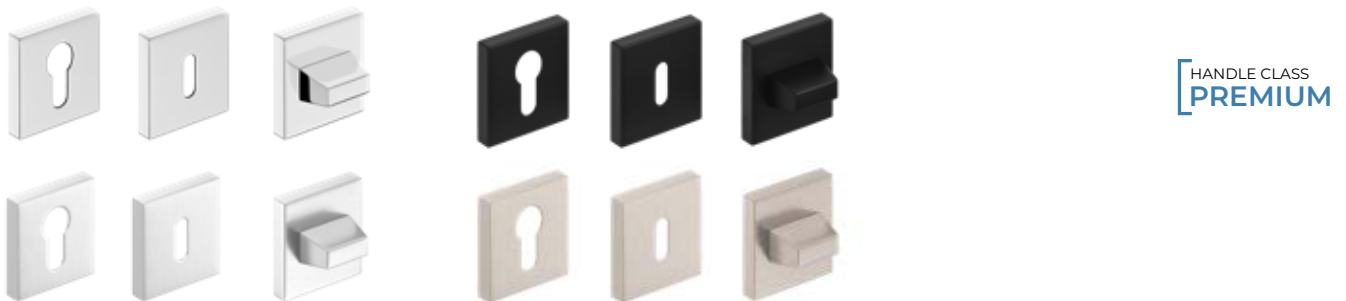

HANDLE CLASS
PREMIUM

METAL-BUD CUBE PREMIUM handle

glossy chrome, brushed matt chrome, brushed matt nickel, black matt

Metal-Bud

PRODUCENT KLAMEK



glossy chrome

brushed matt chrome

brushed matt nickel

black matt

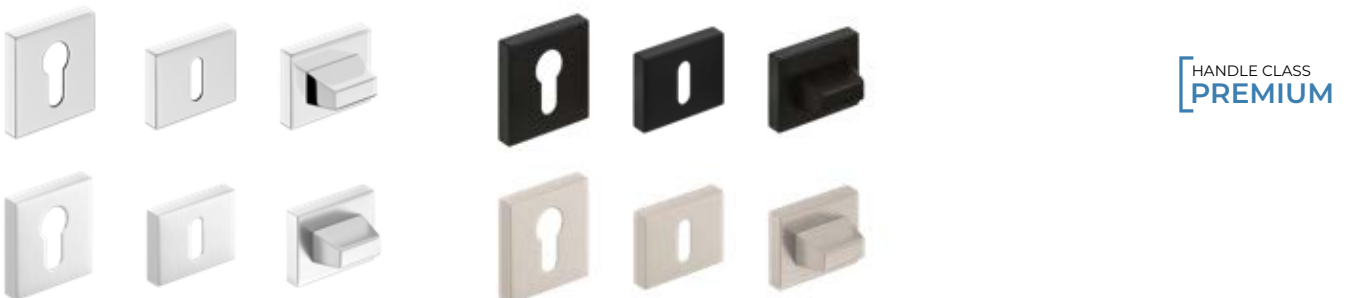

HANDLE CLASS
PREMIUM

HANDLES FOR FLUSH AND PANELLED DOORS

The handle cannot be used for flush doors with casing frames, see p. 174

NEW

METAL-BUD OLIVIA R handle, classic escutcheon

glossy chrome, black matt, glossy brass

Metal-Bud

PRODUCENT KLAMEK



glossy chrome



black matt



glossy brass

NEW

METAL-BUD LAURA R handle, classic escutcheon

glossy chrome, black matt, glossy brass

Metal-Bud

PRODUCENT KLAMEK



glossy chrome



black matt



glossy brass

ESCUTCHEON glossy chrome, black matt, glossy brass for models OLIVIA R, LAURA R, classic escutcheon



NEW

METAL-BUD JULIA R handle

glossy chrome, black matt, glossy brass

Metal-Bud

PRODUCENT KLAMEK



glossy chrome



black matt



glossy brass

ESCUTCHEON glossy chrome, black matt, glossy brass for JULIA R



RUMBA handle with antibacterial coating with active silver ions

black matt



black matt



HANDLES FOR FLUSH AND PANELLED DOORS

The handle cannot be used for flush doors with casing frames, see p. 174

CAMILA and ARTEMIDA handles

satin chrome, patina, matt black



NEW

CAMILA handle chrome, satin



NEW

CAMILA handle, black matt



ARTEMIDA handle patina



ARTEMIDA handle, black matt



METAL-BUD LUNA PREMIUM Handle, SQUARE

glossy chrome, brushed matt chrome, glossy brass, black matt

Metal-Bud

PRODUCENT KLAMEK



glossy chrome



brushed matt chrome



glossy brass



black matt

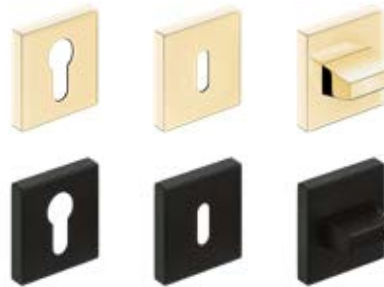
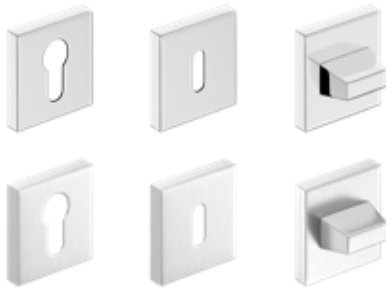

HANDLE CLASS
PREMIUM

NEW

METAL-BUD LUNA SLIM PREMIUM handle, ROUND

glossy chrome, brushed matt chrome, glossy brass, black matt

Metal-Bud

PRODUCENT KLAMEK



glossy chrome



brushed matt chrome



glossy brass



black matt

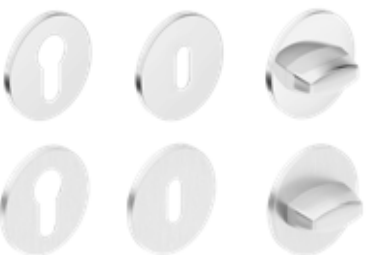

HANDLE CLASS
PREMIUM

HANDLES FOR FLUSH AND PANELLED DOORS

The handle cannot be used for flush doors with casing frames, see p. 174

METAL-BUD DECO texture handle

Metal-Bud

PRODUCENT KLAMEK

glossy chrome, nickel satin



facing layer: MEDIUM OAK GREKO



facing layer: BLACK



facing layer: WHITE GREKO



facing layer: SONOMA GREKO



facing layer: WALNUT GREKO



facing layer: OAK GREKO



facing layer: SANREMO GREKO

METAL-BUD IBIZA Handle

glossy chrome, nickel satin, graphite/chrome, white matt, black matt



glossy chrome



graphite/chrome



nickel satin



white matt



black matt

METAL-BUD LINEA handle

glossy chrome, graphite/chrome, nickel, satin



glossy chrome



graphite/chrome



nickel satin

METAL-BUD TREND Handle

nickel satin, graphite/chrome, glossy chrome



nickel satin



graphite/chrome



glossy chrome

ESCUTCHEON glossy chrome, nickel satin, graphite/chrome, white matte, black matte for **DECO, DECO, IBIZA, LINEA, TREND**



HANDLES FOR FLUSH AND PANELLED DOORS

The handle cannot be used for flush doors with casing frames, see p. 174

METAL-BUD QUBIK handle

nickel velvet, glossy chrome, white matt, black matt

Metal-Bud

PRODUCENT KLAMEK



QUBIK handle, nickel, velvet



QUBIK handle, glossy chrome

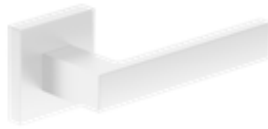

QUBIK handle, white matt



QUBIK handle, black matt



QUBIK handle, glossy brass

METAL-BUD BARCELONA handle

velvet nickel, glossy chrome, matt black, brushed nickel

Metal-Bud

PRODUCENT KLAMEK



BARCELONA handle, nickel, velvet



BARCELONA handle, glossy chrome



BARCELONA handle, black matt



BARCELONA handle brushed nickel

ESCUTCHEON nickel, velvet, glossy chrome, white matt, black matt, glossy brass, brushed nickel, for the **QUBIK, BARCELONA** models

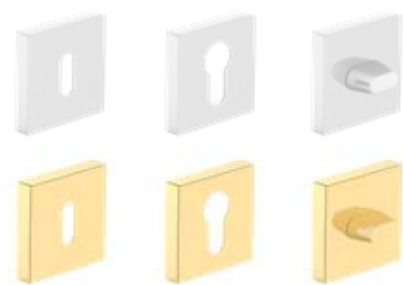
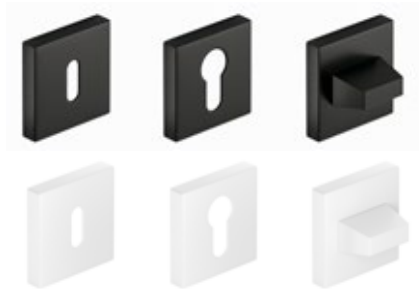

GAMET handles

brushed chrome, glossy chrome, brushed nickel, antique brass



MISTICO handle
glossy chrome



MISTICO handle
brushed nickel



ERBA handle
brushed nickel



ERBA handle
antique brass



CASCADA handle
brushed nickel



CASCADA handle
antique brass



HANDLES FOR FLUSH AND PANELLED DOORS

The handle cannot be used for flush doors with casing frames, see p. 174

NEW

METAL-BUD MONDO handle

Metal-Bud

PRODUCENT KLAMEK

nickel satin



MONDO handle, nickel satin



escutcheon - euro profile



escutcheon - keyhole profile



escutcheon - bathroom

METAL-BUD ERKADO handle

Metal-Bud

PRODUCENT KLAMEK

black matt



TOPAZ handle, black matt



escutcheon - euro profile



escutcheon - keyhole profile



escutcheon - bathroom

METAL-BUD ERKADO handles

inox



SUPRA inox square handle



SUPRA inox round handle



PROXIMA inox round handle



SAPPHIRE inox handle



METRO inox handle



PROXIMA inox square handle



TOPAZ inox handle



ONYX inox handle



NOVA inox square handle



NOVA inox round handle



JOWISZ inox handle



ROMA inox handle



escutcheon - euro profile, inox



escutcheon - keyhole profile, inox



escutcheon - bathroom, inox



escutcheon - euro profile, inox



escutcheon - keyhole profile, inox



escutcheon - bathroom, inox

HANDLES FOR FLUSH AND PANELLED DOORS ON BACKPLATE

The handle cannot be used for flush doors with casing frames, see p. 174

(DOES NOT APPLY TO SYDNEY and QUBIK handles on backplate). The handles on backplate are not used for non-rebated doors (see p. 145)

NEW

JULIA & LUNA handles, on backplate

glossy brass

Metal-Bud

PRODUCENT KLAMEK



JULIA handle, glossy brass
backplate - lock profile, euro profile, latch



JULIA handle, glossy brass
backplate - bathroom

LUNA handle, glossy brass
backplate - lock profile, euro profile, latch

LUNA handle, glossy brass
backplate - bathroom

BLANKA, CAMILA & ARTEMIDA handles on backplate

satin chrome, patina, matt black



BLANKA handle chrome, satin
backplate - lock profile, euro profile, latch

BLANKA handle chrome, satin
backplate - bathroom



CAMILA handle chrome, satin
backplate - lock profile, euro profile, latch

CAMILA handle chrome, satin
backplate - bathroom



ARTEMIDA handle patina
backplate - lock profile, euro profile, latch

ARTEMIDA handle patina
backplate - bathroom



ARTEMIDA handle, black matt
backplate - lock profile, euro profile, latch

ARTEMIDA handle, black matt
backplate - bathroom

METAL-BUD ASTRA, SYDNEY and QUBIK handles on backplate, spacing 72 mm

- the SYDNEY and QUBIK handles not to be used for flush doors with casing frames, see p. 174

nickel, patina, matt black

Metal-Bud

PRODUCENT KLAMEK



ASTRA handle
nickel, patina
backplate - lock profile



ASTRA handle, nickel, satin
backplate - euro profile



ASTRA handle, nickel, satin
backplate - latch



QUBIK handle, black matt
backplate - euro profile, lock profile

QUBIK handle on backplate
black matt
backplate - lock profile

QUBIK handle, black matt
backplate - bathroom



ASTRA and SYDNEY handles, nickel, patina
backplate - bathroom



HANDLES FOR FLUSH AND PANELED DOORS ON BACKPLATE

The handle cannot be used for flush doors with casing frames, see p. 174
(DOES NOT APPLY TO SYDNEY and QUBIK handles on backplate). The handles on backplate are not used for non-rebated doors (see p. 145)

METAL-BUD JOWISZ INOX handles on backplate (10 mm thick), spacing 72 mm

CERTIFIED FOR USE IN LEDA EI30 AND EI 60 FIRE AND FRONT DOORS

Metal-Bud

PRODUCENT KLAMEK

Stainless steel, investment



JOWISZ INOX handle
backplate - lock profile



JOWISZ INOX handle
backplate - bathroom



JOWISZ INOX handle
backplate - euro profile



JOWISZ INOX handle
backplate - latch

METAL-BUD TOPAZ INOX handle on backplate (10 mm thick), spacing 72 mm

stainless steel

Metal-Bud

PRODUCENT KLAMEK



TOPAZ INOX handle
backplate - lock profile



TOPAZ INOX handle
backplate - bathroom



TOPAZ INOX handle
backplate - euro profile



TOPAZ INOX handle
backplate - latch

HANDLES FOR HERSE SET, HERSE LUX SET, HERSE MAX SET

METAL-BUD ERKADO BONN & ESSEN handles ¹⁾ (backplate thickness ESSEN - 10 mm, BONN - 8 mm), spacing 72 mm



stainless steel plus

BONN handle
BONN escutcheon



patina

BONN handle, black matt
BONN escutcheon, black matt



black matt



nickel satin

ESSEN handle ¹⁾
ESSEN escutcheon ¹⁾



patina



black matt

LOCK CORES



Lock core, nickel satin



Lock core with thumbturn,
nickel satin

Lock cores in the master key system 30/45 + 30G/45
Outswing doors - silver, black

Lock cores in the master key system 30/45 + 30/45G
Inswing doors - silver, black

LOCK CORE	LOCK CORE WITH THUMBTURN
Size	Size
26/36	G30/40
30/30	G40/30
30/40	G30/50
30/45	G50/30
30/50	30/45G
	30G/45

¹⁾ ESSEN handles and escutcheons cannot be used with a multipoint lock



TECHNICAL INFORMATION

DOOR OPENING DIRECTIONS

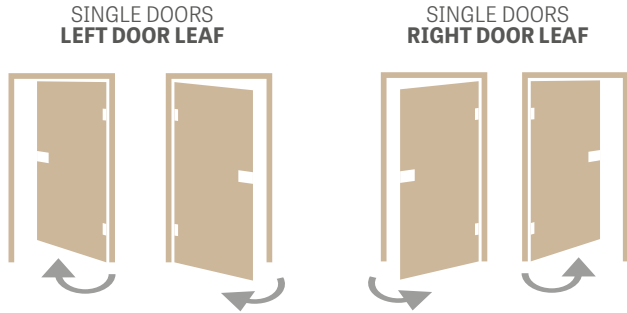

REBATED, NON-REBATED, REVERSE DOORS

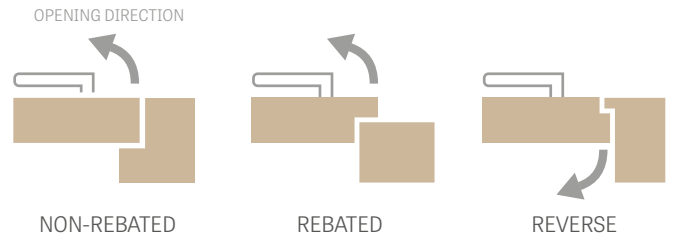

DOUBLE DOORS



DOOR FRAME JOINTS



HOW TO SELECT A LOCK CORE

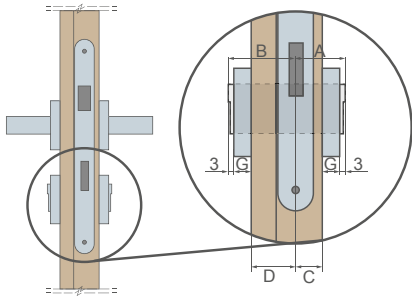

Example of calculating the lock core size for the flush and panelled doors (40mm) with the escutcheon thickness of G = 7 mm

$$A/B = (C+G+3) / (D+G+3)$$

$$A/B = (15+7+3) / (25+7+3)$$

$$A/B = 25/35$$

HOW TO CALCULATE DOOR PRICE

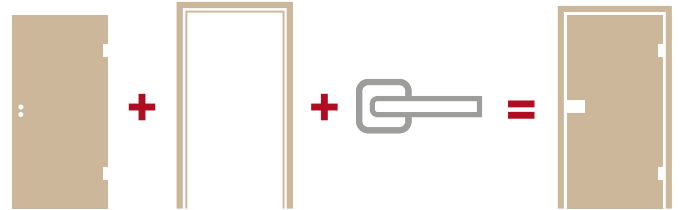

AVAILABLE SOLUTIONS (p. 150-161)

- wall-mounted sliding door systems, single door

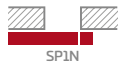

- wall-mounted sliding door systems, double door



- pocket sliding door systems, single door



- pocket sliding door systems, double door

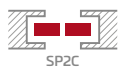

- supplementary system ZN1



- supplementary system ZN2



- double doors



Door type	Door leaf thickness	Proportion of lock setting in door (C/D)	Recommended lock core size (A/B)*
Flush, panelled (rebated)	40 mm	15/25	26/36
Flush, stile (non-rebated)	40 mm	20/20	30/30
reverse	40 mm	15/25	26/36
HERSE	46 mm	15/31	30/45
LEDA EI 30	50 mm	19/31	30/40
LEDA EI 60	60 mm	19/41	30/50
FORTECA RC2 & RC3	46 mm	20/26	30/40
HYPERION EI30 RC2	50 mm	19/31	30/40

* Recommended lock core size for the escutcheon thickness of 7 mm and play of 2 mm to 4 mm

DOOR FACE FINISH TYPES

GREKO

The GREKO laminate is also pre-impregnated, which means printing and then coating with paint with required properties. Using the performance finishing coats adds to the surface's resistance and flexibility of the product. The paint's silicon content ensures the film resistance is enhanced.

The GREKO laminate is manufactured on a high density Japanese base layer which is not resin coated. This makes the film ecological, healthy and safe for people and environment both in the production process and during use, as well as for disposal. No formaldehyde or other harmful ingredients is used.

Its distinctive patterns are what distinguishes the GREKO film. The decors bear striking resemblance to wood, as the high quality surface comes with a 3D natural wood effect. The facings look just like wood.

PREMIUM

The PREMIUM facing is a product based on Polypropylene (PP), a material of very high resistance to abrasion and scratching, plus top quality appearance. It adds a refined looks and individual character to the doors, as it imitates natural wood perfectly.

Not only does the PREMIUM facing attracts with its appearance but with its functionality, as it resists scratching better than average products and is fire-retardant and abrasion resistant. These properties ensure the extended longevity and maintenance-free use of the PREMIUM range products even in most adverse conditions.

ST CPL, CPL 0.2 and CPL 0.7

The CPL facing is composed of a decorative layer impregnated in resins, and a base layer ensuring flexibility. Following the lamination process, the top resin layer is hardened for high resistance to scratching and abrasion. It is characterised by high resistance to impact, abrasion, scratching, heat and UV radiation

Thanks to using this type of material, the door can be installed in so-called "difficult" interiors [exposed to heat, moisture or extraordinary use]. Approx. laminate thickness: ST CPL - 0.15 mm, CPL 0.2 - 0.2 mm and CPL 0.7 - 0.7 mm. The CPL 0.7 laminate is used to cover only one leaf plane thanks to its unique hardness. The CPL 0.2 and CPL 0.7 laminated door leaves come with the leaf edge made of the so-called ABS, a highly durable PVC.

ST CPL facing in white, light grey, cappuccino, black has been refined in the AntiFinger coating limiting dirt and fingerprints. **NEW**

UV VARNISH

The door surface has several coats of the WHITE TITANIUM UV modern UV hardened varnish. The flat surfaces are covered with a specialist base membrane in the first phase, and then coated twice with a top quality paint and hardened with UV.

The moulded surfaces cannot be covered with the membrane for technological reasons, so they are coated with three paint layers and hardened with UV.

The fully automatic coating process follows scanning to ensure ideal quality of the surface. Hardening the paint with the cutting-edge method involving UV light source ensures very high mechanical resistance.

EDGE FINISH TYPES

EDGE SOFT



The SOFT door leaf comes with a chamfered edges, which lends an aesthetic and modern look to it. The leaf is finished with a facing layer of an improved resistance to scratching, which dramatically enhances its resistance during use.



STANDARD EDGE



It involves covering the flat plane with the 0.15 mm ST CPL, CPL 0.2, CPL 0.7 facings, polypropylene PREMIUM facing or GREKO laminate.

The door leaf made in STANDARD technology has unchamfered edges, which is where the face panel is joined with edges facing, as shown in the diagram. The facing layer in the CPL 0.2 and CPL 0.7 laminates is made of very durable PVC, the so-called ABS. The joining method of the facing is also identical for the non-rebated doors and non-rebated sliding systems.



¹⁾ applies only to BALDUR 1 in WHITE ST CPL facing with solid core filling

STILE DOOR

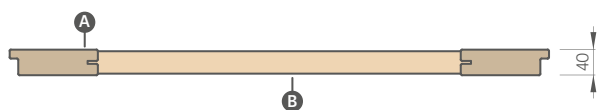
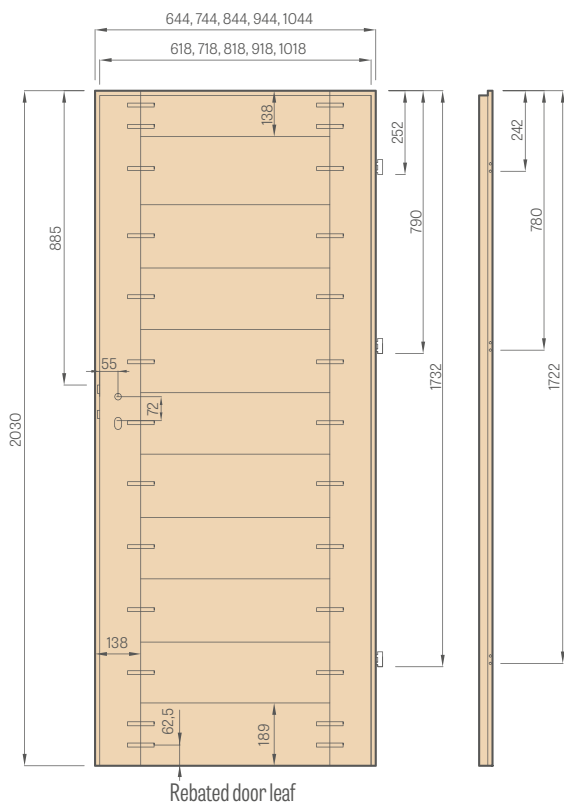

- A** MDF stiles
- B** MDF rails



Solid 35 mm or 22 mm thick rail



Aesthetic frameless tongue-and-groove glazing without bars



MDF stile for the GREKO, PREMIUM and CPL facings, also with the AntiFinger coating

NEW



Glulam stile covered with HDF and MDF boards available at a surcharge for the following decors: WHITE PREMIUM, OAK NATUR PREMIUM, GRAPHITE ASH PREMIUM, GREY MAPLE PREMIUM, OAK ST CPL

FLUSH DOOR

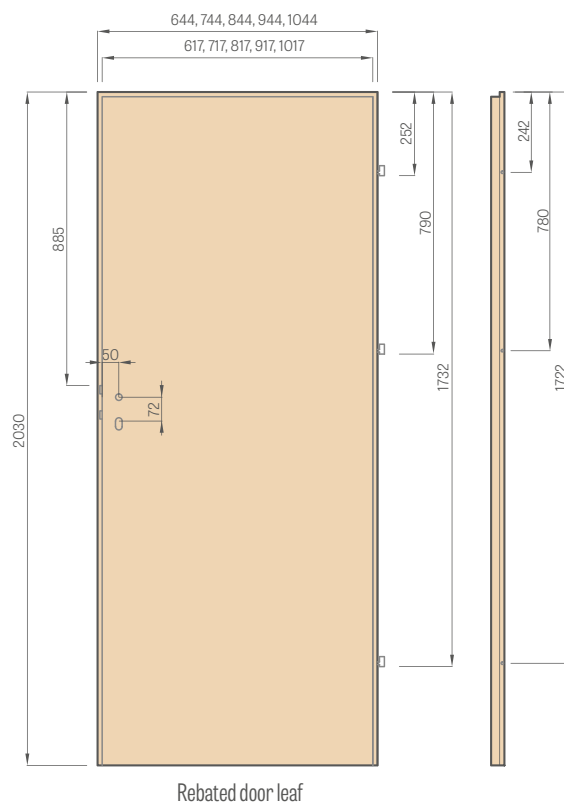

- A** MDF board; **B** gasket; **C** HDF board; **D** filling;
- E** MDF or timber stiles in Herse SET and UNO PREMIUM

FILLING TYPES

Honeycomb



Solid core filling



The honeycomb and the solid core filling in the flush doors ONLY. For the solid core doors we add a third hinge as standard.

GRAF GLASS PANEL

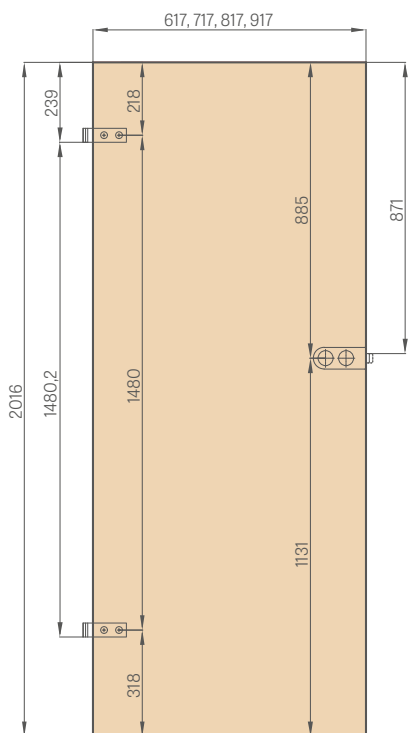

FIRE DOOR LEAF

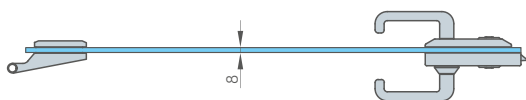
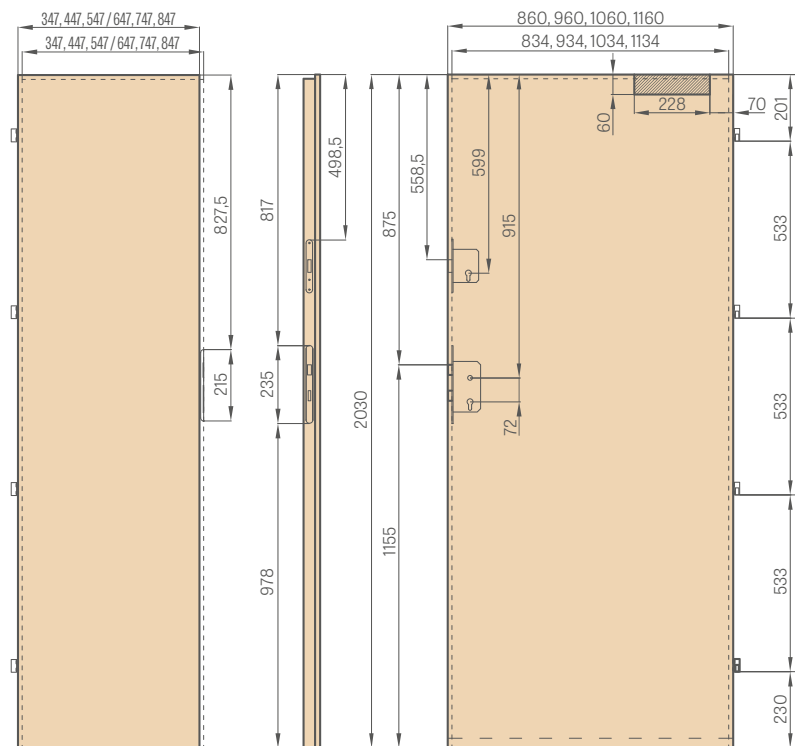

Side panel / inactive door leaf



Active door leaf

BATHROOM TURN & RELEASE

outside (Z)

inside (W)

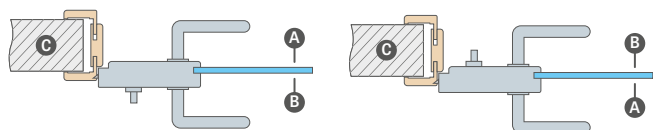

A Corridor; **B** Bathroom; **C** Wall

Bathroom lock – for turn and release locks, select:

- OUTSIDE lock – with the bathroom turn and release is fitted to the outside of the door (Z)
- or
- INSIDE lock – with the bathroom turn and release is fitted to the inside of the door (W)

NOTE: Directions for the turn and release locks apply (R/L)

STANDARD OBVERSE GLAZING



REVERSE GLAZING MADE TO ORDER:

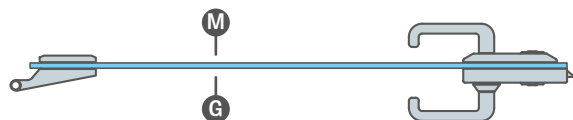

G Plain side; **M** ornamented matt side;



Specially designed HALSPAN board filling
44 mm [EI30] / 54 mm [EI60]



Fire rated and smoke intumescent door gasket in red or black



Drop down seal with pressure adjustment by Allen key



Fixed door frame

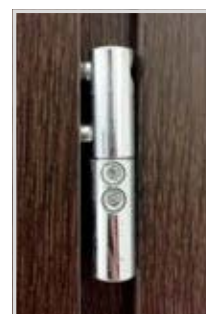

Useful four hinges $\varnothing 16$ with 3D adjustment

CONCEALED MAGNETIC STOPS NEW



glossy chrome, chrome satin, glossy brass, colourless, white semi-matt, black semi-matt



We assemble the magnetic door stop in a special place milled for this purpose on our own. Product delivered as a separate assortment.
Caution (important information in case of underfloor heating): the floor element should be placed in the $\varnothing 14$ mm hole, 45 mm deep.

METAL CAPS FOR HINGES



Brushed nickel, patina, glossy chrome, glossy brass, white matt and black matt

Available casings:

- for Herse/Forteca $\varnothing 16$, length 47 mm in colours: brushed nickel, patina, chrome gloss, brass gloss, white and black
- Hyperion, Leda $\varnothing 16$, length 64 mm in chrome matt and black colours
- for interior leaves $\varnothing 15$, length 47 mm in colours: brushed nickel, patina, chrome gloss, brass gloss, white and black

VENTILATION



Square and round metal sleeves

Plastic woodgrain sleeves for STILE panelled doors for GREKO, PREMIUM and CPL decors



Grilles

VENTILATION FOR AIR TIGHT HOMES

Door undercut - a door is cut at the bottom by 15 mm along its full width. According to standard, doors have to allow a gap of approx. 9 mm above a final floor covering, so a total air gap, including the door undercut, is approx. 24 mm.

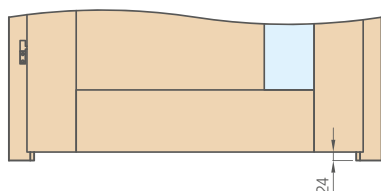

24

VENTILATION

Air gap undercut is not available in non-rebated doors for wall-mounted and pocket sliding doors.

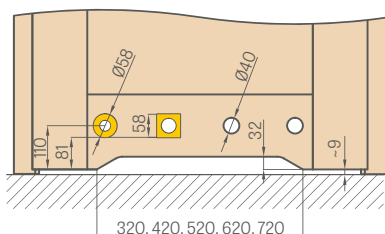

ELECTRIC DOOR STRIKE

(available for fixed and adjustable door frames for rebated and non-rebated doors, see p. 176, 178, 179, but unavailable for the door frames used with the GRAF glass panes and double doors)



Types of electric door strikes:

- basic 12 V
- basic 24 V
- switch operated 12 V
- switch operated 24 V
- reverse 12 V
- reverse 24 V

- BASIC** - normally closed, and opened when voltage is fed
- SWITCH OPERATED** - same operation as in the basic strike, but with an option to be switched off by moving the springbolt
- REVERSE** - closed when voltage is fed, opened when not

The reverse and switch operated electric door strikes unavailable for the fire doors

CUTTING THE DOOR LEAVES

Cutting the door leaves to size by customer acc. to Polish standard, up to 50 mm, or up to 80 mm for the HERSE SET door leaves (unless pre-cut), as well as in the flush doors, is possible if an additional lower rail has been fitted by the manufacturer.

(NOTE: cutting the door leaves to size by customer is not allowed for the FRAGI doors, double and fire doors, non-rebated leaves for sliding systems, glass GRAF doors, FORTECA RC2 and FORTECA RC3 burglar-proof doors, and panelled doors acc. to the CZ standard).

The door leaf height made acc. to the so-called CZ standard is lower than the PL standard by 47 mm.

Leaf type	Handle height as per PL standard (measured from the bottom edge of the door) [mm]
STILE rebated leaves	1107
STILE non-rebate door leaves	1110
rebated flush doors	1110
non-rebated flush doors	1110
reverse flush door	1110
Graf glass doors	1131
FORTECA RC2 & RC3 doors	1038
Herse, Herse Akustic doors	1107
Herse door with a strip lock	1033
Herse United door	1117
Leda EI30, EI60 door	1115
Hyperion EI30 RC2 door	1033

HARDWARE - LEVER TUMBLER LOCKS

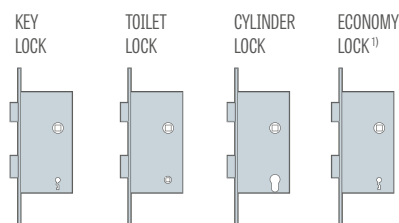

LOCK PZ CENTRES:

- The magnetic lock PZ centres:
 - for keys, toilet doors: 90 mm
 - for lock cores: 85 mm
 - (non-rebated door leaves with a magnetic lock and reversed swing doors)
- The lever tumbler lock PZ centres:
 - for keys, toilet doors, lock core: 72 mm
 - (rebate door leaves and non-rebated door leaves with optional lever tumbler locks)

The toilet locks have a square-shaped bolt hole:

- acc. to PL standard: 4 mm
- acc. to CZ standard: 6 mm

¹⁾ lock provided without a keyhole in the leave

STANDARD "OBSERVE" GLAZING

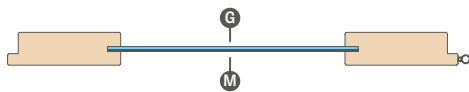

"REVERSE" GLAZING MADE TO ORDER

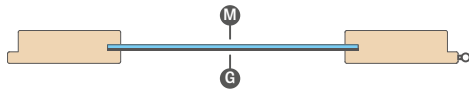

G plain side M matt side with decoration or colourless side with decoration

FROSTED and BLACK VSG 221, 331, 441 LAMINATED GLASS

for STILE panelled doors and flush doors

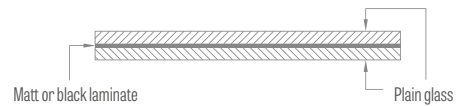

CLEARANCE UNDER DOOR LEAF AFTER INSTALLATION

Please check the lower clearance dimensions on all products prior to installation, as the allowable deviation due to frame dimensional tolerance is ± 3 mm

GLAZING TRANSLUCENCY ILLUSTRATION



GRAF 1 tempered, painted glass



GRAF 12 tempered, painted glass



GRAF 8 decormat



GRAF 9, clear



GRAF 26 dark grey



GRAF 29 laminated glass

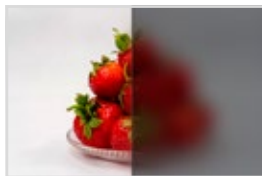

GRAF 11 decormat graphite

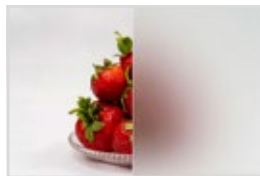

Tempered glass decormat frosted



VSG black or VSG/ESG



VSG frosted or VSG/ESG

FACTORY-DRILLED HANDLE OPENINGS



Factory-drilled handle opening in panelled doors for handles with separate escutcheons available from Erkado.

NON-REBATED & REVERSE HARDWARE



Concealed hinge



Magnetic catch



adjustable magnetic catch strike



Concealed hinge, black



Magnetic lock, black



adjustable magnetic catch strike, black

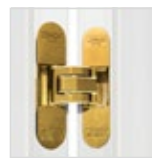

Concealed hinge, golden



Magnetic lock, golden



Adjustable magnetic catch strike, golden

INSTALLATION OF FRAME FOR NON-REBATED DOOR FRAMES

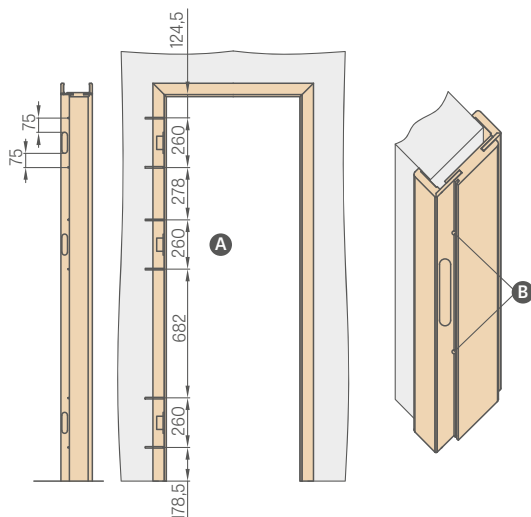

- A Drill holes for metal screws of min length 80 mm x $\varnothing 6$ mm
- B Apart from installation foam, mounting anchors are required when installing the door frame. Drill the holes for screws under the gasket so that it hides them.

CLEANING, REVITALISATION & REGENERATION KIT FOR OTTIMO DOORS





CROSSHEADS AND PILASTERS

PEONIA 1, ASH GREY ST CPL facing layer with CUBE PREMIUM handle, decorative crosshead

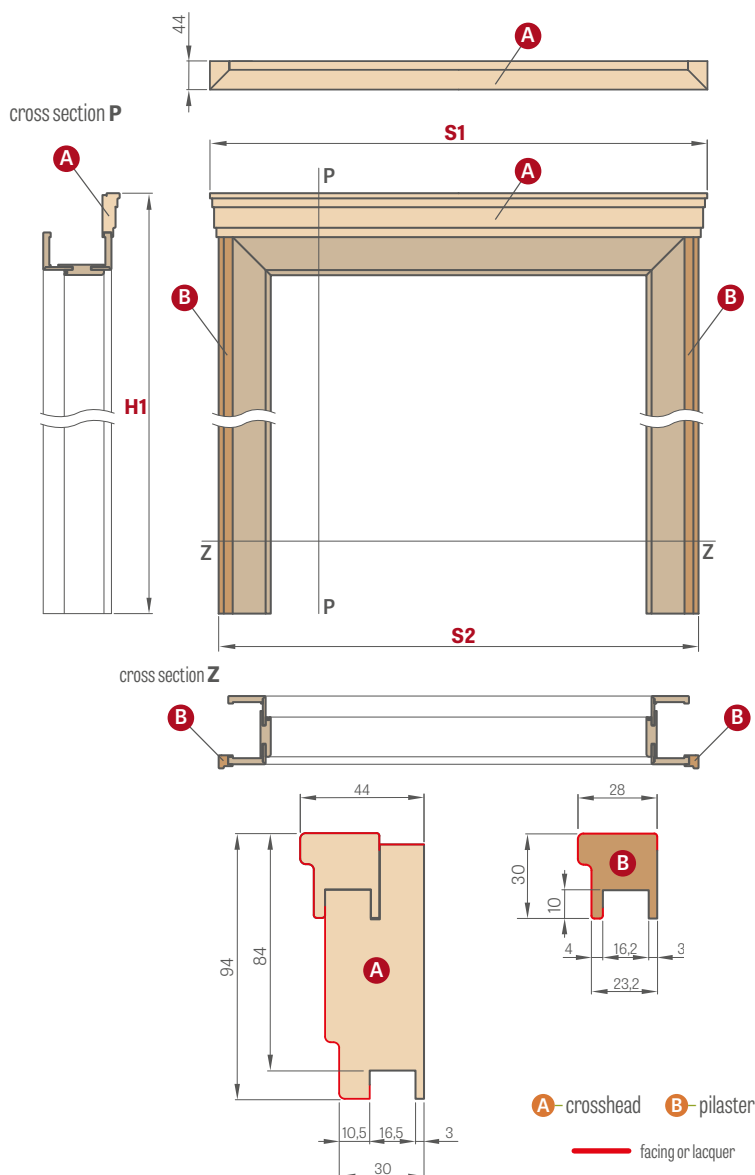

A - crosshead B - pilaster
 — facing or lacquer

Door width	DOOR FRAME and ADJUSTABLE REBATED TUNNEL		DOOR FRAME and ADJUSTABLE NON-REBATED TUNNEL		ADJUSTABLE REVERSE DOOR FRAME	
	S1	S2	S1	S2	S1	S2
"60"	838 ²⁾ /878 ³⁾	788 ²⁾ /828 ³⁾	863 ²⁾ /903 ³⁾	813 ²⁾ /853 ³⁾	883 ⁴⁾ /926 ⁵⁾	833 ⁴⁾ /876 ⁵⁾
"70"	938 ²⁾ /978 ³⁾	888 ²⁾ /928 ³⁾	963 ²⁾ /1003 ³⁾	913 ²⁾ /953 ³⁾	983 ⁴⁾ /1026 ⁵⁾	933 ⁴⁾ /976 ⁵⁾
"80N"	-	-	1039 ²⁾ /1079 ³⁾	989 ²⁾ /1029 ³⁾	1058 ⁴⁾ /1100 ⁵⁾	1008 ⁴⁾ /1050 ⁵⁾
"80"	1038 ²⁾ /1078 ³⁾	988 ²⁾ /1028 ³⁾	1063 ²⁾ /1103 ³⁾	1013 ²⁾ /1053 ³⁾	1083 ⁴⁾ /1126 ⁵⁾	1033 ⁴⁾ /1076 ⁵⁾
"90"	1138 ²⁾ /1178 ³⁾	1088 ²⁾ /1128 ³⁾	1163 ²⁾ /1203 ³⁾	1113 ²⁾ /1153 ³⁾	1183 ⁴⁾ /1226 ⁵⁾	1133 ⁴⁾ /1176 ⁵⁾
"100"	1238 ²⁾ /1278 ³⁾	1188 ²⁾ /1228 ³⁾	1263 ²⁾ /1303 ³⁾	1213 ²⁾ /1253 ³⁾	1283 ⁴⁾ /1326 ⁵⁾	1233 ⁴⁾ /1276 ⁵⁾
"110"	1338 ²⁾ /1378 ³⁾	1288 ²⁾ /1328 ³⁾	1363 ²⁾ /1403 ³⁾	1313 ²⁾ /1353 ³⁾	1383 ⁴⁾ /1426 ⁵⁾	1333 ⁴⁾ /1376 ⁵⁾

²⁾ square with architrave 6 cm, ³⁾ square with architrave 8 cm, ⁴⁾ reverse architrave, ⁵⁾ adjustable square RW

	H1					
	DOOR FRAME and ADJUSTABLE REBATED TUNNEL		DOOR FRAME and ADJUSTABLE NON-REBATED TUNNEL		ADJUSTABLE REVERSE DOOR FRAME	
	Square with architrave 6 cm	Square with architrave 8 cm	Square with architrave 6 cm	Square with architrave 6 cm	Reverse architrave	Adjustable square
PL STANDARD	2174	2194	2187	2207	2207	2229
NORMA EN 2112	2256	2276	2269	2289	-	-

NOTE: The working range of frame will be reduced by 3 mm (for single-sided use) or 6 mm (for double-sided use) when a set (crosshead + pilasters) for the rebated, non-rebated or reverse adjustable frame is selected. Example: assume a 140 mm thick wall with a single-sided kit to be 143 mm thick, while with a double-sided kit to be 146 mm thick, and look for a corresponding masonry coverage in the table for rebated frames (p. 179), non-rebated frames (p. 176) or reverse frames (p. 175).



DOOR FRAME EXTENSION PANELS

WALL-MOUNTED

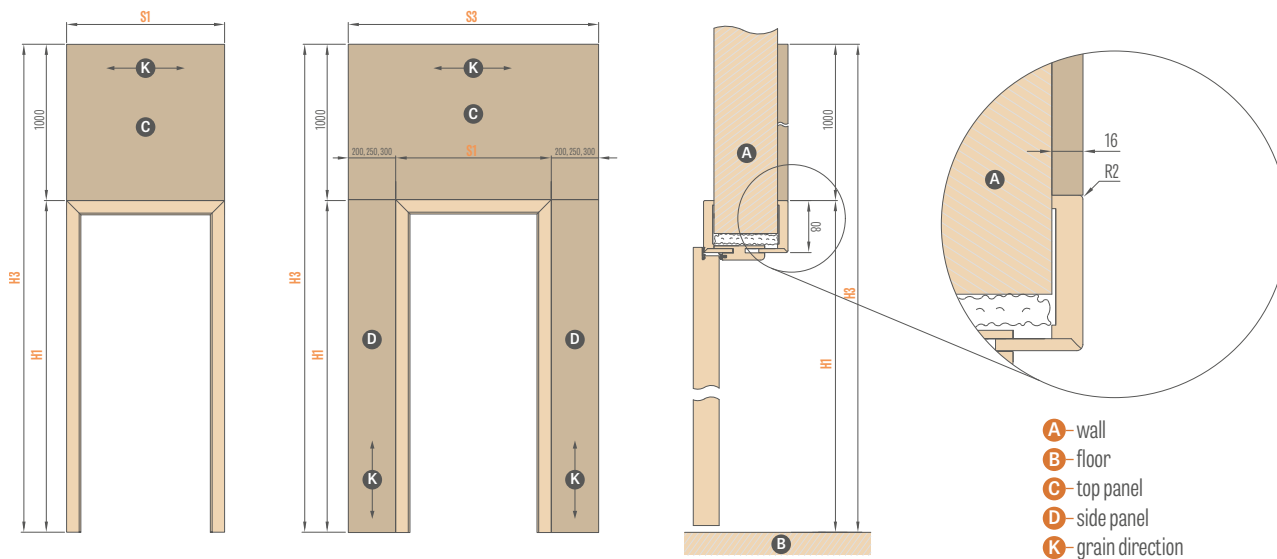

INTERNAL DOORS ¹⁾				
Frame type	H1	H3	Width	S1
Adjustable rebated door frame	2109	3109	"60"	786
			"70"	886
			"80"	986
			"90"	1086
			"100"	1186
Adjustable non-rebated door frame	2122	3122	"60"	811
			"70"	911
			"80"	987
			"90"	1011
			"100"	1111
Reverse door frame (flush with the leaf)	2122	3122	"60"	791
			"70"	891
			"80"	966
			"90"	991
			"100"	1091
REVERSE DOOR FRAME	2144	3144	"60"	834
			"70"	934
			"80"	1010
			"90"	1134
			"100"	1234
			"110"	1334

TOP PANEL (1000 x S1) ¹⁾

FRONT DOOR (panels on the staircase side door opening inwards)										
Frame type	H1	H3	Width	S1	S3					
Adjustable HERSE door frame	2109	3109	"80"	986	1186	1236	1286	1386	1486	1586
			"90E"	1090	1290	1340	1390	1490	1590	1690
			"100"	1186	1386	1436	1486	1586	1686	1786
			"80N"	1012	1212	1262	1312	1412	1512	1612
HERSE fixed door frame "clip-on"	2142	3142	"80"	1052	1252	1302	1352	1452	1552	1652
			"90E"	1156	1356	1406	1456	1556	1656	1756
			"100"	1252	1452	1502	1552	1652	1762	1852
FORTECA fixed "clip-on" door frame	2147	3147	"80N"	1012	1212	1262	1312	1412	1512	1612
			"80"	1056	1256	1306	1356	1456	1556	1656
			"90E"	1156	1356	1406	1456	1556	1656	1756
			"100"	1256	1456	1506	1556	1656	1756	1856
FORTECA fixed frame with adjustment (installation side)	2136	3136	"80N"	990	1190	1240	1290	1390	1490	1590
			"80"	1034	1234	1284	1334	1434	1534	1634
			"90E"	1134	1334	1384	1434	1534	1634	1734
LEDA, HYPERION fixed door frame "clip-on"	2147	3147	"80"	1085	1285	1335	1385	1485	1585	1685
			"90E"	1185	1385	1435	1485	1585	1685	1785
			"100"	1285	1485	1535	1585	1685	1785	1885
LEDA, HYPERION adjustable fixed frame (installation side)	2136	3136	"80"	1063	1263	1313	1363	1463	1563	1663
			"90E"	1163	1363	1413	1463	1563	1663	1763
			"100"	1263	1463	1513	1563	1663	1763	1863

PANEL 200	PANEL 250	PANEL 300	2 x PANEL 200	2 x PANEL 250	2 x PANEL 300
SINGLE-FACE SIDE PANEL			DOUBLE-FACE SIDE PANEL		

DOOR FRAME EXTENSION PANELS ²⁾ – price per m ²
GREKO
CPLO.2, ST CPL and PREMIUM
PAINTED

¹⁾ only top panels are available for interior door frames

²⁾ the panels shall be edged on all four edges in a colour similar to that of the panel surface the area is calculated from the tables above.



INTEGRATED ONE-SIDE EXTENSION PANELS

MOUNTED INSTEAD OF AN ADJUSTABLE SQUARE OR WITH A CLIP

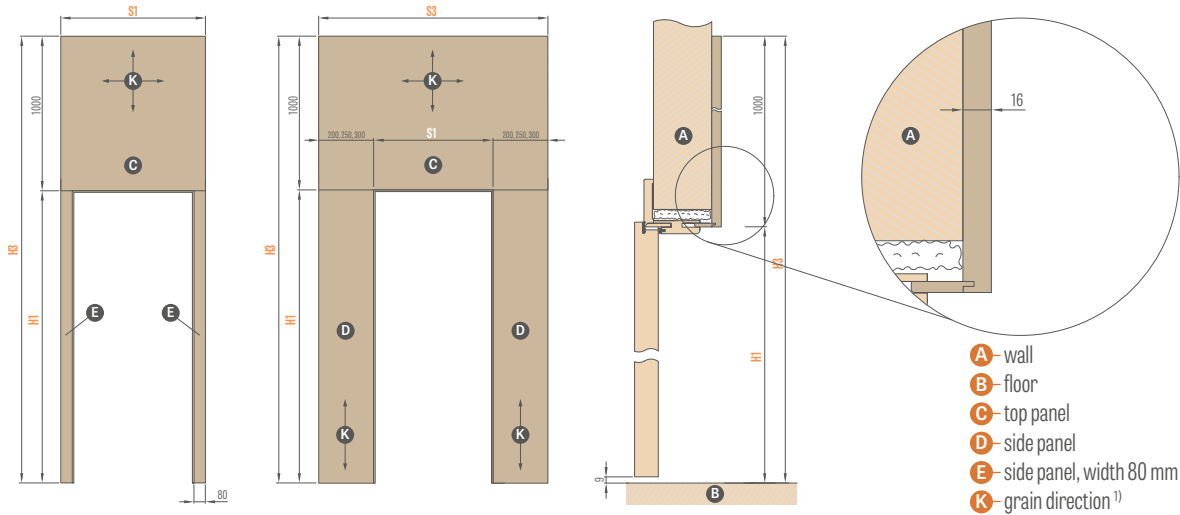

- A** - wall
- B** - floor
- C** - top panel
- D** - side panel
- E** - side panel, width 80 mm
- K** - grain direction ¹⁾

INTERNAL DOORS ²⁾				
Frame type	H1	H3	Width	S1
Adjustable rebated door frame (adjustable square section side)	2029	3029	"60"	786
			"70"	886
			"80"	986
			"90"	1086
			"100"	1186
Adjustable non-rebated door frame (adjustable square section side)	2042	3042	"60"	811
			"70"	911
			"80"	987
			"90"	1011
			"100"	1111
Reverse door frame (adjustable square side)	2064	3064	"60"	834
			"70"	934
			"80"	1010
			"90"	1134
			"100"	1234
TOP PANEL (1000 x S1) ¹⁾				

FRONT DOOR (panels on the staircase side door opening inwards)											
Frame type	H1	H3	Width	S1	S3						
HERSE adjustable door frame (adjustable square section side)	2029	3029	"80"	986	1106	1156	1206	1226	1326	1426	
			"90E"	1090	1210	1260	1310	1330	1430	1530	
			"100"	1186	1306	1356	1406	1426	1526	1626	
			"110"	1286							
HERSE fixed door frame "clip-on"	2062	3062	"80N"	1012	1132	1182	1232	1252	1352	1452	
			"80"	1052	1172	1222	1272	1292	1392	1492	
			"90E"	1156	1276	1326	1376	1396	1496	1596	
			"100"	1252	1372	1422	1472	1492	1592	1692	
FORTECA fixed "clip-on" door frame	2068	3068	"80N"	1012	1132	1182	1232	1252	1352	1452	
			"80"	1056	1176	1226	1276	1296	1396	1496	
			"90E"	1156	1276	1326	1376	1396	1496	1596	
			"100"	1256	1376	1426	1476	1496	1596	1696	
FORTECA fixed frame with adjustment (installation side)	2057	3057	"80N"	990	1110	1160	1210	1230	1330	1430	
			"80"	1034	1154	1204	1254	1274	1374	1474	
			"90E"	1134	1254	1304	1354	1374	1474	1574	
LEDA, HYPERION fixed door frame "clip-on"	2068	3068	"80"	1085	1205	1255	1305	1325	1425	1525	
			"90E"	1185	1305	1355	1405	1425	1525	1625	
			"100"	1285	1405	1455	1505	1525	1625	1725	
			"110" ⁴⁾	1385 ⁴⁾	1505 ⁴⁾	1555 ⁴⁾	1605 ⁴⁾	1625 ⁴⁾	1725 ⁴⁾	1825 ⁴⁾	
LEDA, HYPERION adjustable fixed frame (installation side)	2057	3057	"80"	1063	1183	1233	1283	1303	1403	1503	
			"90E"	1163	1283	1333	1383	1403	1503	1603	
			"100"	1263	1383	1433	1483	1503	1603	1703	
			"110" ⁴⁾	1363 ⁴⁾	1483 ⁴⁾	1533 ⁴⁾	1583 ⁴⁾	1603 ⁴⁾	1703 ⁴⁾	1803 ⁴⁾	

PANEL 200	PANEL 250	PANEL 300	2x PANEL 200	2x PANEL 250	2x PANEL 300
SINGLE-FACE SIDE PANEL			DOUBLE-FACE SIDE PANEL		

DOOR FRAME EXTENSION PANELS ³⁾ – price per m ²
GREKO
CPL 0.2, ST CPL and PREMIUM
PAINTED

¹⁾ the grain direction in the top panel up to a panel width of S1 ≤ 1050 mm can be chosen as horizontal or vertical, while above S1 > 1050 mm, as horizontal only

²⁾ only top panels are available for interior door frames

³⁾ the panels shall be edged on all four edges in a colour similar to that of the panel surface. The area is calculated from the tables above.

⁴⁾ valid for LEDA doors only



SLIDING SYSTEMS

WALL-MOUNTED

WALL-MOUNTED SLIDING DOOR SYSTEM:

SINGLE SP1Nz (with bolt keeper)	
SINGLE SP1Nb (w/o bolt keeper)	
DOUBLE SP2N	

Price includes:

Aluminium track with a cover profile and door stop in the colour of the door leaf and length:

- 210 cm for "100" leaves
- 200 cm for "90" leaves
- 180 cm for "80" leaves
- 150 cm for "70" "60" leaves

Available wall-mounted sliding system sets

- Track with a cover profile and door stop with gasket (only SP1Nz & SP1Nb)
- Track with a cover profile and tunnel door frame (only for SP2N)
- Track with a cover profile and door stop + tunnel door frame (only SP1Nz & SP1Nb)
- Track with a cover profile and door stop with gasket + tunnel door frame (only SP1Nz & SP1Nb)

The SP1N and SP2N wall-mounted sliding door system with selected door leaves is also available as per the PL2112 standard.

The non-rebated door leaf for wall-mounted sliding system cannot have an air gap undercut.

The cover profile is neither laminated nor paint coated on the inside.

EXTRA CHARGES

"tunnel" type adjustable door frame

included in the price of the adjustable frame

hook bolt lock with hardware

only for the single door system

oval, rectangular or round pull handle

glossy chrome, brushed chrome, glossy brass, black matt; two pcs. of pull handles per set

synchronisation

simultaneous opening and closing of the door leaves using only one leaf; only for SP2N

soft closing damper

automatic leaf damping during the final closing phase

Only for SP1Nz and SP1Nb

standard 2112

surcharge for door leaves under standard 2112 and as the "tunnel" version

ROUND, OVAL AND RECTANGULAR PULL HANDLES ¹⁾

glossy chrome, brushed chrome, glossy brass, black matt



¹⁾ in the BALDUR 8 model, the oval and square pull handles overlap the moulding

HOOK BOLT KEY LOCKS

glossy chrome,
brushed chrome,
shiny brass,
black matt

key only in silver



the hook bolt key lock comes with two pull handles to choose



WALL-MOUNTED SLIDING DOOR SYSTEM

WITH DOOR OPENING HOUSING

SP1Nz or SP1Nb (left, obverse version)

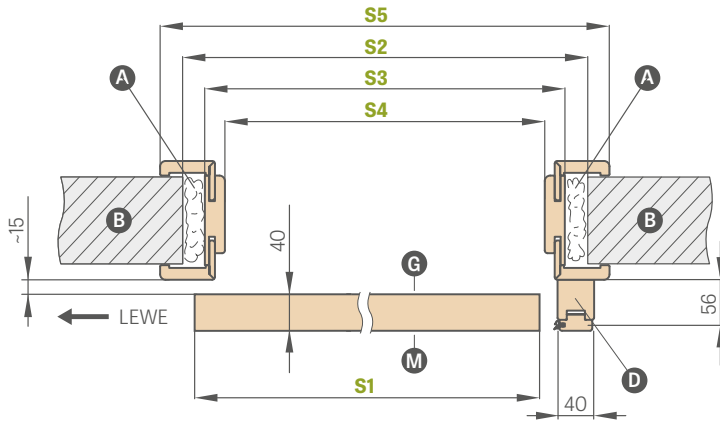

SP2N (obverse version)

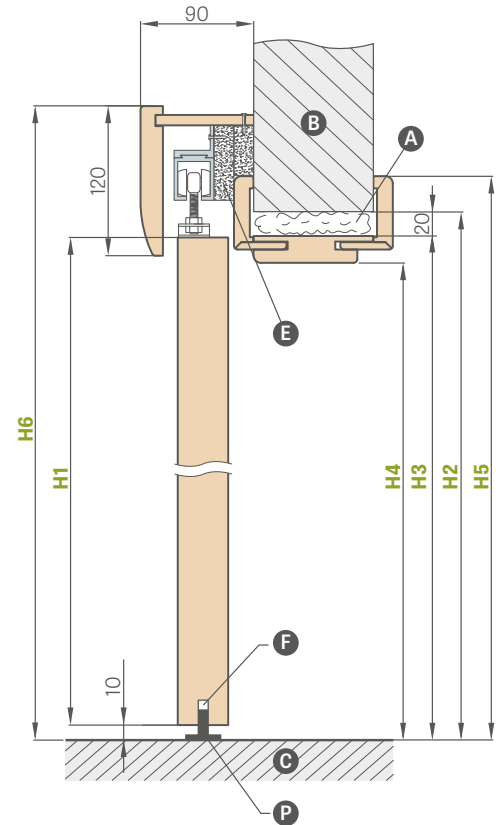
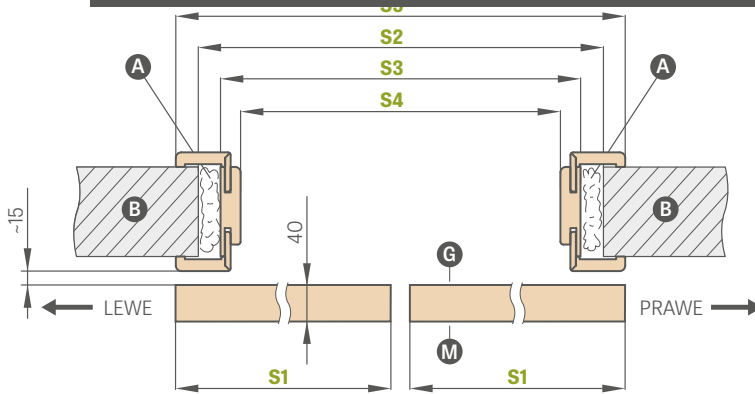

- A** - foam
- B** - wall
- C** - floor
- D** - door stop (directional as per the PL2112 standard)
- E** - spacer strip
- F** - milled groove for the guide rail
- G** - smooth side of the glass
- P** - floor guide rail
- M** - glass matt side

WALL-MOUNTED SLIDING DOOR SYSTEM WITH DOOR OPENING HOUSING

	SINGLE DOORS					DOUBLE DOORS				
	"60"	"70"	"80"	"90"	"100"	"60" x 2	"70" x 2	"80" x 2	"90" x 2	"100" x 2
S1 Door leaf width	644	744	844	944	1044	1288	1488	1688	1888	2088
S2 Opening width in the wall	688	788	888	988	1088	1288	1488	1688	1888	2088
S3 Frame outer width	648	748	848	948	1048	1248	1448	1648	1848	2048
S4 Frame opening width	604	704	804	904	1004	1204	1404	1604	1804	2004
S4 Opening width in the wall for SPN w/o housing	604	704	804	904	1004	1204	1404	1604	1804	2004
S5 Frame cover width Architraves 6cm / Architraves 8cm	746 / 786	846 / 886	946 / 986	1046 / 1086	1146 / 1186	1346 / 1386	1546 / 1586	1746 / 1786	1946 / 1986	2146 / NA
H1 Door leaf height	2030 (2112) ¹⁾									
H2 Opening height in the wall	2060 (2142) ¹⁾									
H2 Opening height in the wall for SPN w/o housing	2020 (2102) ¹⁾									
H3 Frame outer height	2040 (2122) ¹⁾									
H4 Frame opening height	2018 (2100) ¹⁾									
H5 Frame cover height architrave 6 cm / architrave 8 cm	2089 / 2109 (2171 / 2191) ¹⁾									2089 / none (2171 / 2191) ¹⁾
H6 Overall system height	2142 (2224) ¹⁾									

¹⁾ PL2112 standard



WALL-MOUNTED SLIDING DOOR SYSTEM

LOFT STANDARD TYPE



Leaf BALDUR 7, WHITE TITAN UV facing layer, black rectangular pull handles, INDUSTRIAL door hangers

The LOFT STANDARD single sliding system is available with all leaves in the SP1N standard wall mounted sliding system.

Double sliding system LOFT STANDARD consists of two single door systems and a connecting element for rails.

Double LOFT STANDARD system is counted as 2 x single door system + connecting element for rails. Three door hangers to choose from: INDUSTRIAL, RETRO and ART (p. 153).

LOFT STANDARD sliding door system

oval, rectangular or round pull handle³⁾

door closer on one side

connector for tracks (enables the use of the LOFT system in the double door system)

Standard 2112 – surcharge for doors under Standard 2112

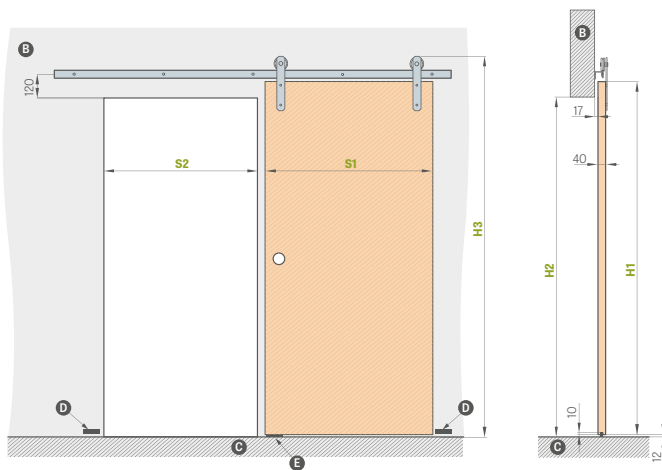

		"60"	"70"	"80"	"90"	"100"
S1	Door leaf width	644	744	844	944	1044
S2	Opening width in the wall ¹⁾	574	674	774	874	974
H1	Door leaf height	2030	2030	2030	2030	2030
H2	Opening height in the wall	1962	1962	1962	1962	1962
H3	Overall system height	2170	2170	2170	2170	2170

GUIDE RAIL FOR SINGLE DOOR SYSTEM LENGTH:

- 200 cm for "60" "70" "80" leaves

- 250 cm for "90" "100" leaves

¹⁾ the leaf in the closed position overlaps 35 mm on each side

²⁾ a guide for double door system consists of two guides connected with a connector

³⁾ in the BALDUR 8 model, the oval and square pull handles overlap the moulding

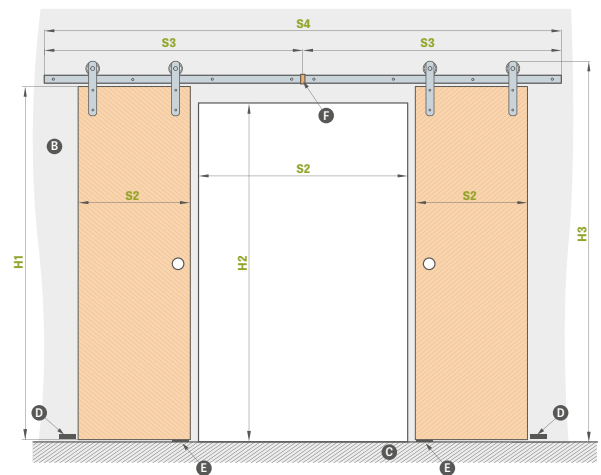

		"120"	"140"	"160"	"180"	"200"
S1	Door leaf width	2 x 644	2 x 744	2 x 844	2 x 944	2 x 1044
S2	Opening width in the wall ¹⁾	1202	1402	1602	1802	2002
S3	Guide width	1500	1500	2000	2000	2200
S4	Total guide width ²⁾	3000	3000	4000	4000	4400
H1	Door leaf height	2030	2030	2030	2030	2030
H2	Opening height in the wall	1962	1962	1962	1962	1962
H3	Overall system height	2170	2170	2170	2170	2170

B – wall **C** – floor **D** – wall mounted buffer
E – guide **F** – guide connector²⁾



WALL-MOUNTED SLIDING DOOR SYSTEM

LOFT Type



LOFT door leaf, OAK ST CPL facing layer, round pull handle, RETRO door hangers

LOFT Type wall-mounted sliding door system is available in black and incorporates the LOFT Type solid core door leaf. The LOFT door leaf comes with a rigid honeycomb infill as standard or solid core panel for extra charge. The door leaf features a non-rebated edge. The system is designed for clear finished opening, without a tunnel.

The complete system includes the sliding LOFT system + LOFT door leaf + pull handle + door closer on one or both side(s).

The LOFT double door system is counted as 2 x single door system + connecting rail element. Three door hangers to choose from: INDUSTRIAL, RETRO and ART.

LOFT sliding door system

oval, rectangular or round pull handle

solid core filling

round and square metal ventilation sleeves (4 pieces); black matt

door closer on one side

connector for tracks (enables the use of the LOFT system in the double door system)

black door leaf edge finish

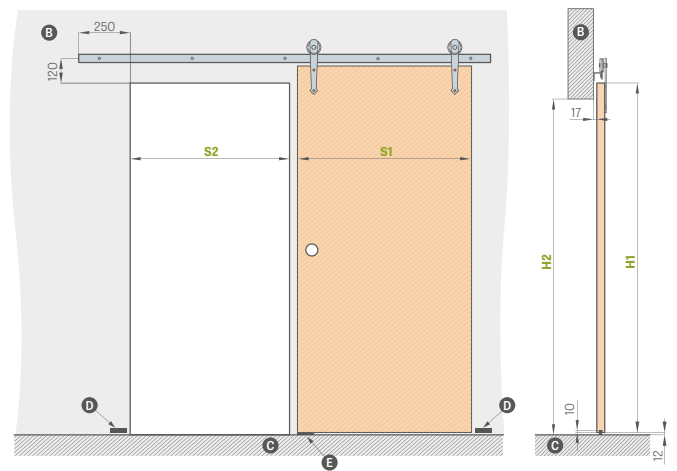

	"60"	"70"	"80"	"90"	"100"
S1 Door leaf width	644	744	844	944	1044
S2 Opening width in the wall	574	674	774	874	974
H1 Door leaf height	2150	2150	2150	2150	2150
H2 Opening height in the wall	2082	2082	2082	2082	2082

B - wall **C** - floor **D** - wall-mounted buffer **E** - guide

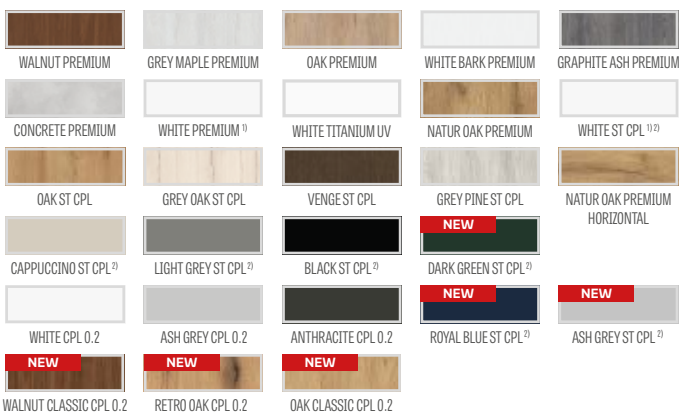

¹⁾ plain white facing imitating a painted surface

²⁾ special **AntiFinger** **NEW** coating to reduce dirt and fingerprints

ROUND, OVAL, RECTANGULAR PULL HANDLES

glossy chrome, brushed chrome, glossy brass, black matt



GUIDE RAIL LENGTHS:

- 200 cm for "60" "70" "80" leaves
- 250 cm for "90" "100" leaves

DOOR HANGERS



BLACK PLAIN DOOR LEAF EDGE FINISH

BLACK HORIZONTAL DOOR LEAF EDGE FINISH



WALL-MOUNTED SLIDING DOOR SYSTEM

MAGIC Type



MAGIC door leaf, OAK PREMIUM facing layer, oval pull handle

MAGIC Type wall-mounted sliding door system incorporates the MAGIC Type solid core door leaf only. The MAGIC door leaf comes with a rigid honeycomb infill as standard or solid core panel for extra charge. The door leaf features a non-rebated edge. The system is designed for clear finished opening, without a tunnel.

The complete system includes the sliding MAGIC system + MAGIC door leaf + pull handle. The system is only available as a complete set (system + leaf).

MAGIC SLIDING DOOR SYSTEM

oval, rectangular or round pull handle

solid core filling

round and square metal sleeves (4 pcs);
glossy chrome, brushed chrome, black matt

black door leaf edge finish

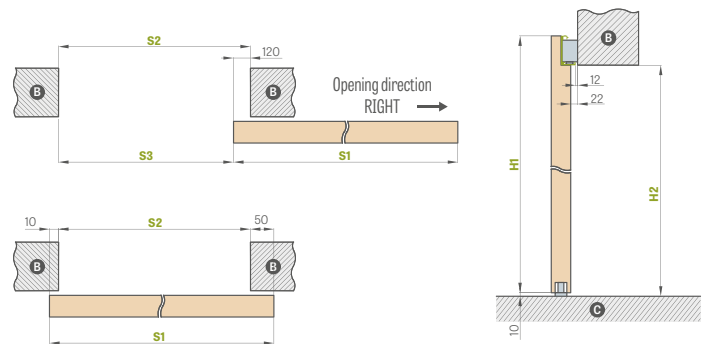

MAGIC WALL-MOUNTED SLIDING DOOR SYSTEM

		"60"	"70"	"80"	"90"	"100"
S1	Door leaf width	644	744	844	944	1044
S2	Opening width in the wall	584	684	784	884	984
S3	Transition light	464	564	664	764	864
H1	Door leaf height	2150	2150	2150	2150	2150
H2	Opening height in the wall	2100	2100	2100	2100	2100

B - wall **C** - floor

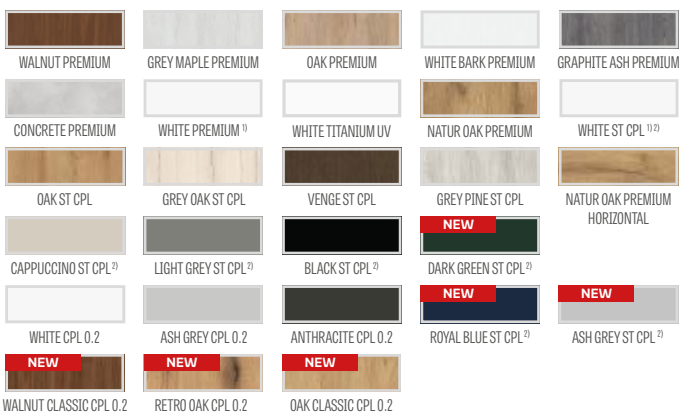

ROUND, OVAL, RECTANGULAR PULL HANDLES

glossy chrome, brushed chrome, glossy brass, black matt

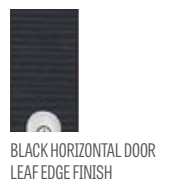

¹⁾ plain white facing imitating a painted surface

²⁾ special **AntiFinger** **NEW** coating to reduce dirt and fingerprints



WALL-MOUNTED SLIDING DOOR SYSTEM

GRAF GLASS DOORS



GRAF 61 SYSTEM

Sliding system for glass doors with a silver anodised aluminium or black matt powder-painted cover. This system is complete and designed for fitting in a clear finished opening, as the tunnel is not available. The system range includes all GRAF glass panes, see p. 60-61 and go to our website: www.erkado.pl and the B2B panel.

The complete system includes: sliding SYSTEM GRAF + glass pane SYSTEM GRAF + pull handle + door closer on one side

GLASS DOOR SLIDING SYSTEM

- silver anode
- black matt

double-sided round pull handle, stainless steel

double-sided round pull handle, stainless steel, black matt

double-sided round pull handle, anodised aluminium
colour inox or matt black (powder-coated)

"90" glass pane extra charge

door closer

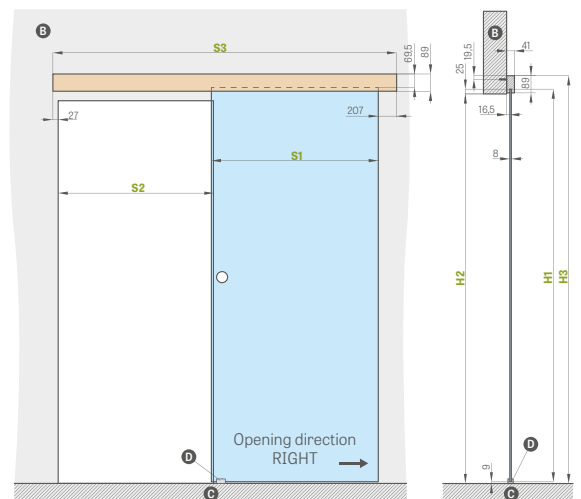

WALL-MOUNTED GLASS DOOR SLIDING SYSTEM

		"60"	"70"	"80"	"90"
S1	Door leaf width	662	762	862	962
S2	Opening width in the wall	602	702	802	902
S3	Guide rail length	1500	1500	1800	2000
H1	Door leaf height	2036			
H2	Opening height in the wall	max 2020			
H3	Overall system height	2114			

PULL HANDLE



stainless steel, matt black
(external diameter 54 mm)

anodised aluminium
inox, matt black powder-coated
(external diameter 65 mm)





B - wall **C** - floor **D** - guide shoe

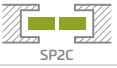
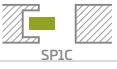

SLIDING SYSTEMS

POCKET SYSTEMS

ERKADO pocket door system range includes:

BASIC TUNNEL INSTALLATION		
SP1C.100		Single "100" pocket sliding system only available for STILE panelled doors, painted doors and ALTAMURA 1, UNO PREMIUM and UNO LUX models
SP2C.100		Double "100" pocket sliding system only available for STILE panelled doors and ALTAMURA 1 and UNO PREMIUM models
SP1C.125		Single "125" pocket sliding system
SP2C.125		Double "125" pocket sliding system
ZN1		One-sided supplementary basic in-wall installation for SP1C.100 or SP1C.125 system
ZN2		One-sided supplementary basic in-wall installation for SP2C.100 or SP2C.125 system

Not available for CPLO.2 & CPLO.7 laminates

$$\text{SLIDING SYSTEM PRICE} = \text{DOOR LEAF PRICE} + \text{ALUMINIUM POCKET PRICE} + \text{BASIC TUNNEL INSTALLATION PRICE} + \text{OPTIONAL INSTALLATION PRICE ZN1 OR ZN2}$$

Standard single/double pocket sliding system includes:

- aluminium case [LEON] SP1
- aluminium case [LEON] SP2
- non-rebated door leaf / two non-rebated door leaves – price for standard door leaf / price for two door leaves
- basic tunnel installation (see table above)
- tunnel installation ZN1 or ZN 2 – see table on the next page

ROUND, OVAL AND RECTANGULAR PULL HANDLES ¹⁾

glossy chrome, brushed chrome, glossy brass, black matt



HOOK BOLT KEY LOCKS

glossy chrome,
brushed chrome,
shiny brass,
black matt



Key only in silver

The hook bolt key lock comes with two pull handles to choose

EXTRA CHARGES

frame joints at 90 degrees

Hook bolt lock with hardware

only available for: SP1C.100, SP1C.125

oval, rectangular or round pull handle

glossy chrome, brushed chrome, glossy brass, black matt
available for SP1C.100, SP2C.100, SP1C.125, SP2C.125

pull handle set includes two pcs.

finger pull

glossy chrome, brushed chrome, glossy brass, black matt

synchronisation

simultaneous opening and closing of the door leaves using only one leaf
only available for: SP2C.100, SP2C.125

soft closing damper

automatic soft close in the final closing phase; available for SP1C.100, SP1C.125 only

standard 2112

surcharge for door leaves under standard 2112, pockets and housings

¹⁾ in the BALDUR 8 model, the oval and square pull handles overlap the moulding

IN-WALL INSTALLATION IN THE SINGLE DOOR SYSTEM FOR ONE SIDE ZN1

One-sided adjustment range for the basic wall
min-max (mm)

0-40; 40-60; 60-80;
80-100; 100-120; 120-140
140-160; 160-180; 180-200
200-220; 220-240
240-260; 260-280
280-300; 300-320
320-340; 340-360

- The system of one-sided in-wall installation for double doors ZN2 + 30% extra of the prices in table above
- Surcharge of 15% for Standard 2112

SINGLE & DOUBLE POCKET SLIDING SYSTEMS

		"60"	"70"	"80"	"90"	"100"	2 x "60"	2 x "70"	2 x "80"	2 x "90"	2 x "100"
S1	Door leaf width	644	744	844	944	1044	1288	1488	1688	1888	2088
S2	Frame opening width	604	704	804	904	1004	1204	1404	1604	1804	2004
S3	Pocket width	1318	1518	1718	1918	2118	2538	2938	3338	3738	4138
S4	Frame cover width	746 /	846 /	946 /	1046 /	1146 /	1346 /	1546 /	1746 /	1946 /	2146 /
	Architraves 6cm / Architraves 8cm	786	886	986	1086	1186	1386	1586	1786	1986	NA
S5	Opening width in the pocket	655	755	855	955	1055	1255	1455	1655	1855	2055
S6	Opening width in the wall	1338	1538	1738	1938	2138	2558	2958	3358	3758	4158
H1	Door leaf height	2030 (2112) ¹⁾									
H2	Frame cover height Architraves 6cm / Architraves 8cm	2092 / 2112 (2174 / 2194) ¹⁾									2092 / none (2174 / none) ¹⁾
H3	Pocket height	2115 (2197) ¹⁾									
H4	Frame opening height	2021 (2103) ¹⁾									
H5	Opening height in the wall	2125 (2207) ¹⁾									

¹⁾ PL2112 standard



Photo: Wall-mounted sliding system

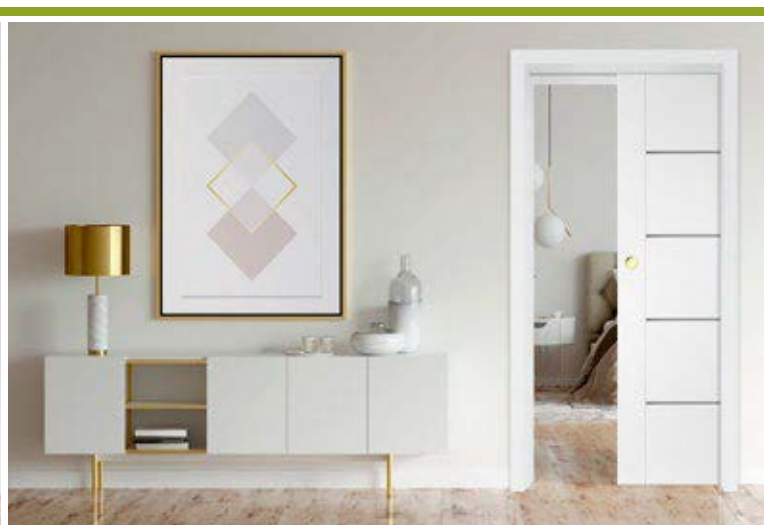

Photo: Pocket sliding system



SINGLE AND DOUBLE DOOR SYSTEMS

POCKET SYSTEMS

SP1C.100 (left, AWERS obverse glazing)

Fixed range of 100 mm

Pocket thickness before gypsum board installation – 75 mm

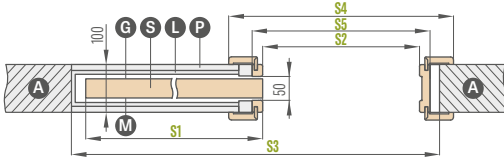

For UNO PREMIUM, ALTAMURA 1 only, and for all panelled doors.
The system does not come with dust brushes (not required).

SP1C.125 (left, AWERS obverse glazing)

Fixed range of 125 mm

Pocket thickness before gypsum board installation – 100 mm

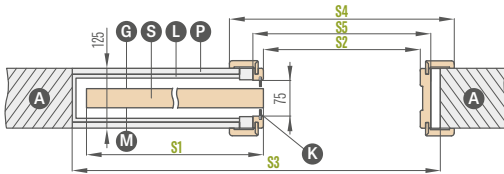

Only for use with flush doors which are supplied with a glass frame.
The system includes grey dust brushes.

ZN1 one-sided basic in-wall installation for SP1C.100 and SP1C.125

basic in-wall installation range from 0-40; 40-60; ... 340-360

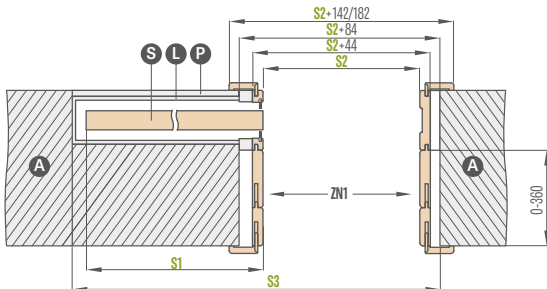

The drawing shows a one-sided the basic in-wall installation ZN1.

SP2C.100 (AWERS obverse glazing)

Fixed range of 100 mm

Pocket thickness before gypsum board installation – 75 mm

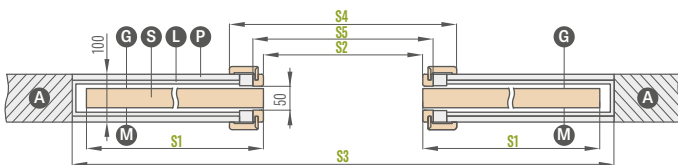

For UNO PREMIUM, ALTAMURA 1 only, and for all panelled doors.
The system does not come with dust brushes (not required).

SP2C.125 (AWERS obverse glazing)

Fixed range of 125 mm

Pocket thickness before gypsum board installation – 100 mm

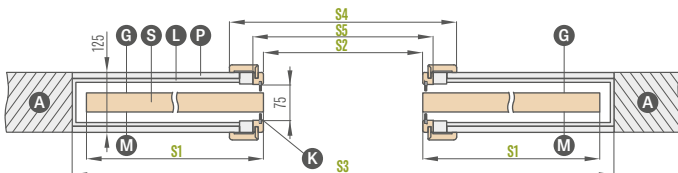

Only for use with flush doors which are supplied with a glass frame.
The system includes grey dust brushes.

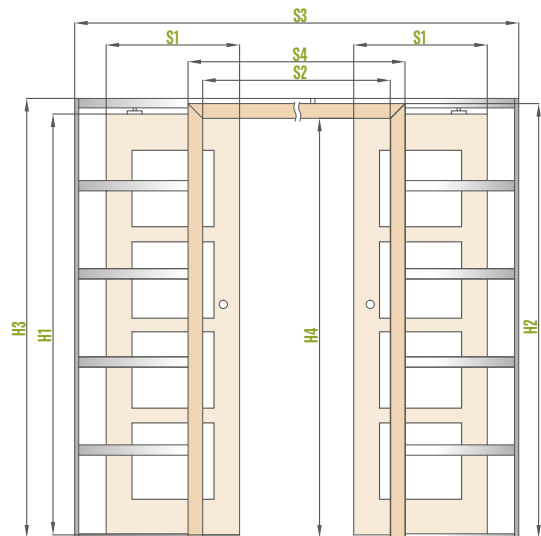
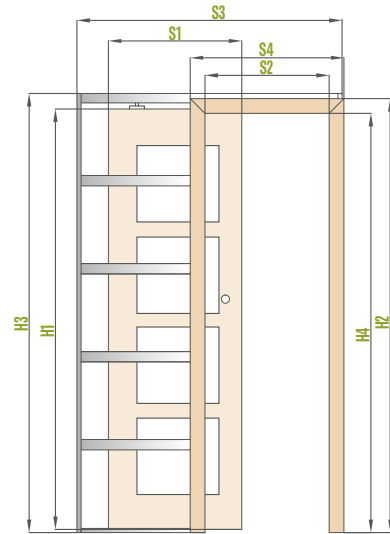

- A – wall
- L – aluminium case
- P – gypsum board
- K – dust brushes
- G – smooth smooth side of the glass
- M – glass matt side
- S – leaf

ZN2 one-sided basic in-wall installation for SP2C.100 and SP2C.125

basic in-wall installation range from 0-40; 40-60; ... 340-360

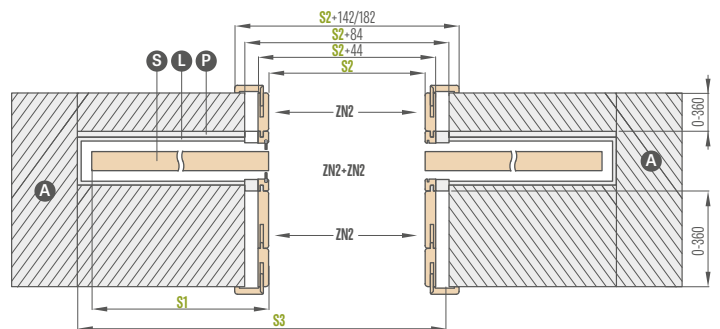

The drawing shows double-sided the basic in-wall installation ZN2 + ZN2.



DOUBLE DOORS

REBATED AND NON-REBATED

USEFUL INFORMATION

DOUBLE DOORS



- the double doors are supplied with a solid core infill for extra charge
- the double doors are made according to available models of the flush single doors, STILE panelled doors with respective features: colour, finish (STANDARD, SOFT), glazing etc.
- double doors available in CPL 0.2 & CPL 0.7
- passive doors use pull latches
- under "60" width passive door available as a solid core, plain version only – side panel (see drawing below)
- side panels are made in the STANDARD edge flush technology. Available with a honeycomb infill as standard or solid core panel for extra charge. Grain direction of the side panels is vertical.
- both active and inactive door leaves come with lippings
- lippings in CPL 0.7 door leaves are laminated with CPL 0.2
- the double doors in non-rebated technology are available with a magnetic lock only
- double non-rebated leaf doors come with an adjustable door frame only
- electric door strike is not available for the double doors
- PL2112 Standard for selected door leaves

AVAILABLE DOOR LEAF WIDTHS

- flush and panelled DOUBLE DOORS from "120" to "190"*** and mixes with solid core, plain side panels

60 + 30*	70 + 30*	80 + 30*	90 + 30*	100 + 30*
60 + 40*	70 + 40*	80 + 40*	90 + 40*	100 + 40*
60 + 50*	70 + 50*	80 + 50*	90 + 50*	100 + 50*

- * side panel available in standard technology only as a solid core, plain version
- ** for "180" non-rebated doors

DOUBLE DOOR PRICE:

- flush and panelled: active leaf **60 70 80 90 100** + passive leaf **60 70 80 90***

$$\text{price of double doors with lipping} = \text{door leaf price x 2} + \text{lippings}$$

- flush and panelled: active leaf **60 70 80 90 100** + solid core, plain passive side panels **30 40 50**

$$\text{price of double doors with side panel and lipping} = \text{door leaf price} + \text{solid core side panel with lippings}$$

- prices of fixed and adjustable door frames for double doors + 30%
- extra charge for solid core in a side panel
- painted side panel only with solid core WHITE TITANIUM UV – surcharge

* not in the non-rebated door leaves



DOUBLE DOORS

NON-REBATED

NON-REBATED DOUBLE DOORS WITH ADJUSTABLE DOOR FRAME

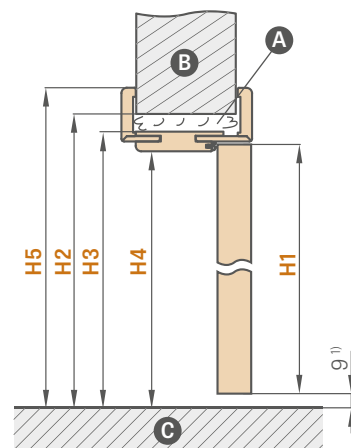
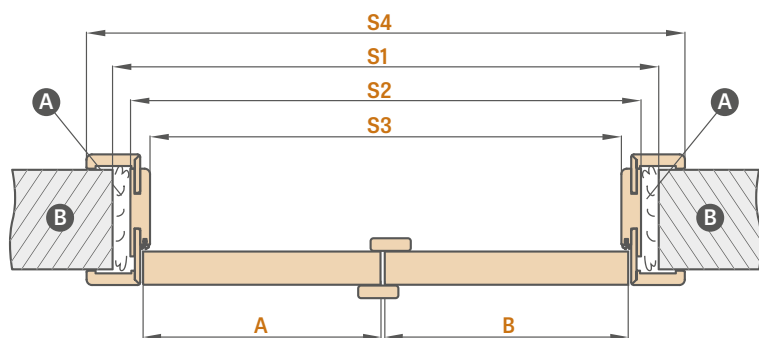

A - foam B - wall C - floor

¹⁾ allowable deviation due to frame dimensional tolerance of $\pm 3\text{mm}$ (we recommend to check before installation)

Adjustable door frame	NON-REBATED DOUBLE DOORS									
	"90"	"100"	"110"	"120"	"130"	"140"	"150"	"160"	"170"	"180"
A+B Door leaf width	988	1088	1188	1288	1388	1488	1588	1688	1788	1888
S1 Opening width in the wall	1061	1161	1261	1361	1461	1561	1661	1761	1861	1961
S2 Frame outer width	1021	1121	1221	1321	1421	1521	1621	1721	1821	1921
S3 Frame opening width	977	1077	1177	1277	1377	1477	1577	1677	1777	1877
S4 Frame cover width Architraves 6cm / Architraves 8cm	1119 / 1159	1219 / 1259	1319 / 1359	1419 / 1459	1519 / 1559	1619 / 1659	1719 / 1759	1819 / 1859	1919 / 1959	2019 / 2059
H1 Door leaf height	2030 (2112) ²⁾									
H2 Opening height in the wall	2073 (2155) ²⁾									
H3 Frame outer height	2053 (2135) ²⁾									
H4 Frame opening height	2031 (2113) ²⁾									
H5 Frame cover height architrave 6 cm / architrave 8 cm	2102 / 2122 (2184 / 2204) ²⁾									

DOUBLE DOORS
- SYMMETRIC



DOUBLE DOORS
- ASYMMETRIC



DOUBLE DOORS
- WITH SOLID CORE, PLAIN SIDE PANEL

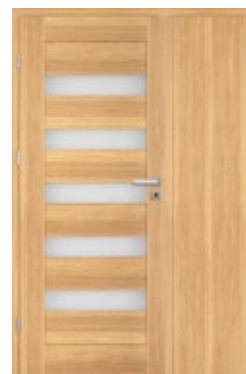

²⁾ PL2112 standard



DOUBLE DOORS

REBATED

REBATED DOUBLE DOORS WITH ADJUSTABLE DOOR FRAME

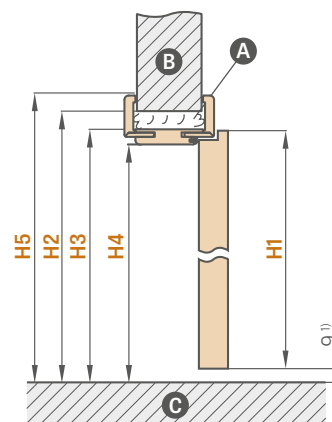
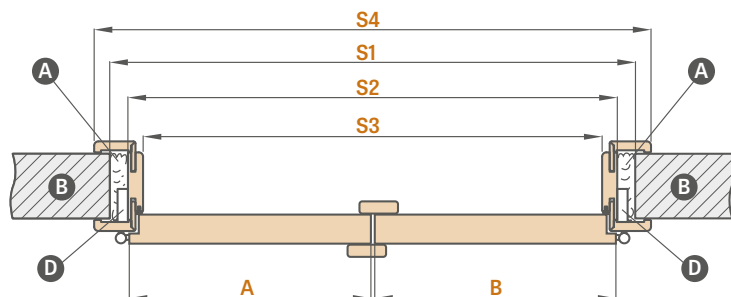

A-foam B-wall C-floor D-hinge seat

Adjustable door frame		DOUBLE DOORS										
		"90"	"100"	"110"	"120"	"130"	"140"	"150"	"160"	"170"	"180"	"190"
A+B	Door leaf width	988	1088	1188	1288	1388	1488	1588	1688	1788	1888	1988
S1	Opening width in the wall	1034	1134	1234	1334	1434	1534	1634	1734	1834	1934	2034
S2	Frame outer width	994	1094	1194	1294	1394	1494	1594	1694	1794	1894	1994
S3	Frame opening width	950	1050	1150	1250	1350	1450	1550	1650	1750	1850	1950
S4	Frame cover width Architraves 6cm/Architraves 8cm	1092 / 1132	1192 / 1232	1292 / 1332	1392 / 1432	1492 / 1532	1592 / 1632	1692 / 1732	1792 / 1832	1892 / 1932	1992 / 2032	2092 / 2132
H1	Door leaf height	2030 (2112) ²⁾										
H2	Opening height in the wall	2060 (2142) ²⁾										
H3	Frame outer height	2040 (2122) ²⁾										
H4	Frame opening height	2018 (2100) ²⁾										
H5	Frame cover height architrave 6 cm/architrave 8 cm	2089 / 2109 (2171 / 2191) ²⁾										

REBATED DOUBLE DOORS WITH FIXED DOOR FRAME

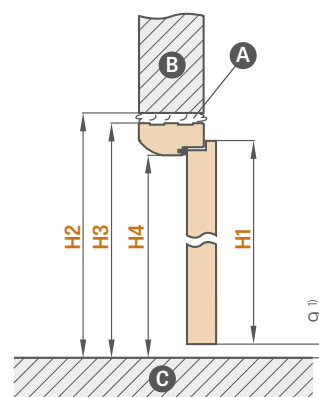
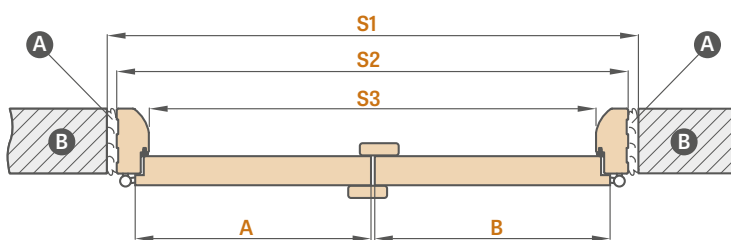

A-foam B-wall C-floor

Fixed door frame		DOUBLE DOORS										
		"90"	"100"	"110"	"120"	"130"	"140"	"150"	"160"	"170"	"180"	"190"
A+B	Door leaf width	988	1088	1188	1288	1388	1488	1588	1688	1788	1888	1988
S1	Opening width in the wall	1068	1168	1268	1368	1468	1568	1668	1768	1868	1968	2068
S2	Frame outer width	1038	1138	1238	1338	1438	1538	1638	1738	1838	1938	2038
S3	Frame opening width	950	1050	1150	1250	1350	1450	1550	1650	1750	1850	1950
H1	Door leaf height	2030	2030	2030	2030	2030	2030	2030	2030	2030	2030	2030
H2	Opening height in the wall	2077	2077	2077	2077	2077	2077	2077	2077	2077	2077	2077
H3	Frame outer height	2062	2062	2062	2062	2062	2062	2062	2062	2062	2062	2062
H4	Frame opening height	2018	2018	2018	2018	2018	2018	2018	2018	2018	2018	2018

¹⁾ allowable deviation due to frame dimensional tolerance of +-3mm (we recommend to check before installation)

²⁾ PL2112 standard



FOLDING DOORS



FOLDING DOOR LEAF

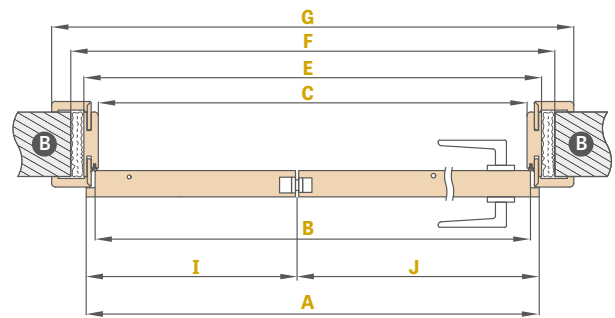
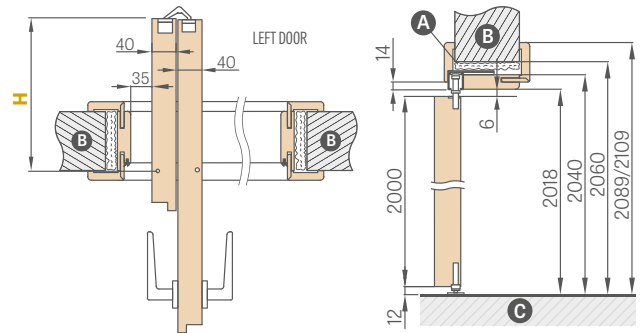

Door width	A	B	C	E	F	G	H	I	J
"60"	641	614	604	648	688	746*/786**	152.5	218	418
"70"	741	714	704	748	788	846*/886**	202.5	268	468
"80"	841	814	804	848	888	946*/986**	252.5	318	518
"90"	941	914	904	948	988	1046*/1086**	302.5	368	568
"100"	1041	1014	1004	1048	1088	1146*/1186**	352.5	418	618

* Architraves 6 cm / ** Architraves 8 cm; joints at 45 degrees only

AVAILABLE DOOR LEAF WIDTHS

60 70 80 90 100



Installation video
<https://youtu.be/tzccmzy7rvq>

Adjustment Range min-max (mm)
80-100
100-120
120-140
140-160
160-180
180-200
200-220
220-240

Adjustment Range min-max (mm)
240-260
260-280
280-320
320-340
340-360
360-380
380-400
400-420

CONSTRUCTION

- the door leaf is composed of two parts joined with concealed hinges
- MDF stile covered with two HDF boards or internal timber stiles and rails covered with two HDF boards for PREMIUM and CPL facings
- rigid honeycomb infill or solid core infill for additional charge
- the door frame above 320 mm is composed of two parts, and above 400 mm, of three parts.

FINISHING

- HDF board with a facing layer
- STANDARD leaf edge
- the door edge faced with edging in the same colour as the door leaf plane or optionally in black plain edging (black edging with horizontal grain for the HORIZONTAL NATUR OAK PREMIUM facing)

HARDWARE

- three concealed hinges between leaves
- concealed guiding system in the top and bottom door sections
- a lever tumbler lock, euro profile cylinder, economy lock or with a thumb turn

EXTRA CHARGES

solid core filling

"100" door leaf

black door leaf edge finish

CPL 0.2 door leaf

CPL 0.7 door leaf

STANDARD				
LIGHT ACACIA GREKO	WHITE GREKO ¹⁾	SNOW-WHITE GREKO ¹⁾	MEDIUM OAK GREKO	ELM GREKO
WALNUT GREKO	SANREMO GREKO	SONOMA GREKO	OAK GREKO	GOLDEN OAK GREKO
GREY OAK GREKO	GREY MAPLE PREMIUM	OAK PREMIUM	WHITE BARK PREMIUM	GRAPHITE ASH PREMIUM
WALNUT PREMIUM	CONCRETE PREMIUM	WHITE PREMIUM ¹⁾	NATUR OAK PREMIUM	NATUR OAK PREMIUM HORIZONTAL ³⁾
OAK ST CPL	GREY OAK ST CPL	VENGE ST CPL	GREY PINE ST CPL	
CAPPUCCINO ST CPL ²⁾	LIGHT GREY ST CPL ²⁾	BLACK ST CPL ²⁾	WHITE ST CPL ¹⁾²⁾	NEW WALNUT CLASSIC CPL 0.2 & 0.7
NEW DARK GREEN ST CPL ²⁾	NEW ROYAL BLUE ST CPL ²⁾	NEW ASH GREY ST CPL ²⁾	NEW OAK RETRO CPL 0.2 & 0.7	NEW OAK CLASSIC CPL 0.2 & 0.7

¹⁾ plain white facing imitating a painted surface

²⁾ special AntiFinger coating to reduce dirt and fingerprints

³⁾ comes complete with the NATUR OAK PREMIUM door frame

Surcharge for every 2 cm (based on the price for the range of 400-420 mm) up to the range of 500-520 mm



COVERT CONCEALED DOOR SYSTEM

OPENING INWARDS AND OUTWARDS



REBATED AND NON-REBATED DOOR LEAF

ALUMINIUM CONCEALED DOOR FRAME

CONSTRUCTION

- rebated or non-rebated door leaf
- wooden stile covered with two HDF boards
- rigid honeycomb infill or solid core infill for additional charge

FINISHING

- HDF board covered with PREMIUM facing, UV paint or a facing layer designed for subsequent paint coating or wallpapering
- door leaf edge made in rebated or non-rebated technology

HARDWARE

- required two mortise hinges in the door frame (third optional, at an extra charge)
- magnetic lock in the rebated and non-rebated leaf: with a key, thumb turn cylinder, economy or with a blockade

EXTRA CHARGES

white or black door frame ³⁾

painted door leaf; WHITE TITANIUM UV

solid core filling

additional bottom rail in the door leaf (can be trimmed by a customer up to max 8 cm)

round and square metal sleeves (4 pcs);
finish: brushed nickel, patina, white and black

plastic woodgrain sleeves (4 pcs)

door undercut (p. 145), air gap undercut or ventilation grille

third hinge

can be changed to a black magnetic catch in the leaf

can be changed to hinges and strike plate in black

- for two hinges or

- for three hinges

black door leaf edge finish

"100" door leaf

drop down seal ⁴⁾

LUX inlay; available versions p. 86-91

magnetic stop (buffer) ⁴⁾
(available in six colours p. 145)

Standard 2112 – surcharge for door leaf and frame

AVAILABLE DOOR LEAF WIDTHS

60 70⁵⁾ 80⁵⁾ 90 100

¹⁾ plain white facing imitating a painted surface

²⁾ used for wallpaper hanging and painting

³⁾ aluminium colour frame as standard

⁴⁾ the stop prevents application of a drop down seal, door undercut, air gap undercut and vice versa

⁵⁾ WHITE BASE leaves and aluminium door frame width "70" and "80" available on short lead times – ask your dealer for details

⁶⁾ special AntiFinger coating to reduce dirt and fingerprints

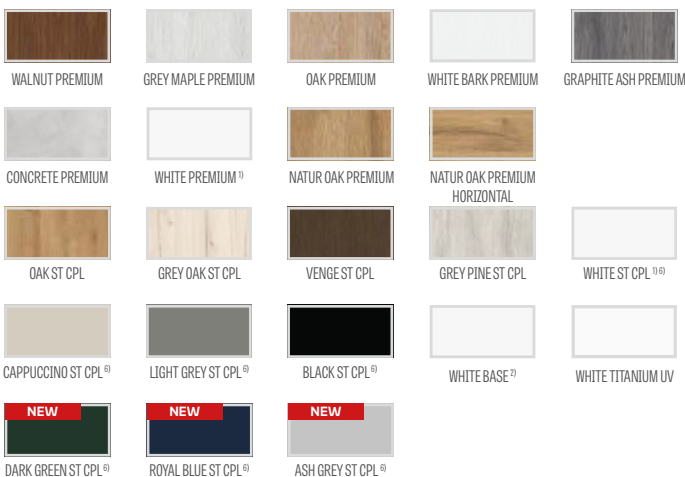



COVERT CONCEALED DOOR SYSTEM

INWARDS OPENING REBATED DOOR LEAF

REBATED DOOR LEAF

ALUMINIUM CONCEALED DOOR FRAME

STANDARD DIMENSIONS FOR INWARDS OPENING REBATED DOOR LEAVES

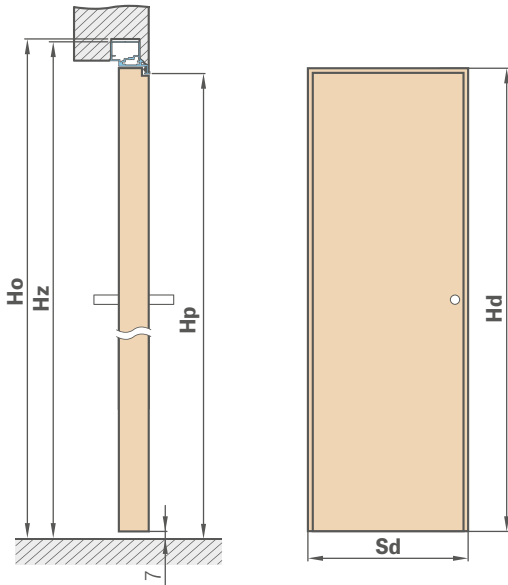

Door leaf width	Construction opening width	Frame outer width	Clear opening width
Sd [mm]	So [mm]	Sz [mm]	Sp [mm]
620	700	690	605
720	800	790	705
820	900	890	805
920	1000	990	905
1020	1100	1090	1005

Door leaf height	Construction opening height	Frame outer height	Clear opening height
Hd [mm]	Ho [mm]	Hz [mm]	Hp [mm]
2030 (2112 ¹⁾)	2079 (2162 ¹⁾)	2072 (2154 ¹⁾)	2030 (2112 ¹⁾)

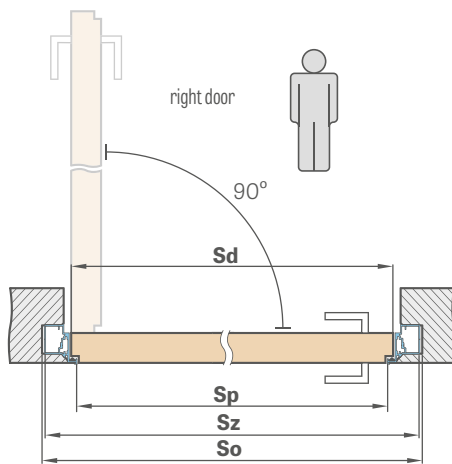

Gypsum board installation

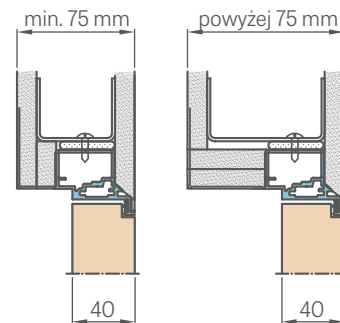

ALUMINIUM DOOR FRAME CROSS-SECTION

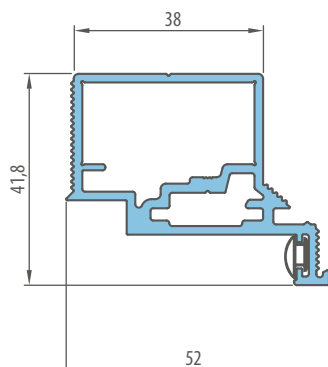

ENCLOSED IN WALL

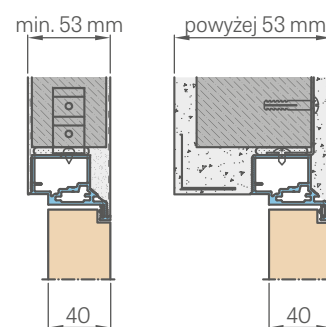



COVERT CONCEALED DOOR SYSTEM

OUTWARDS OPENING NON-REBATED DOOR LEAF

NON-REBATED DOOR LEAF

ALUMINIUM CONCEALED DOOR FRAME

STANDARD DIMENSIONS FOR OUTWARDS OPENING NON-REBATED DOOR LEAVES

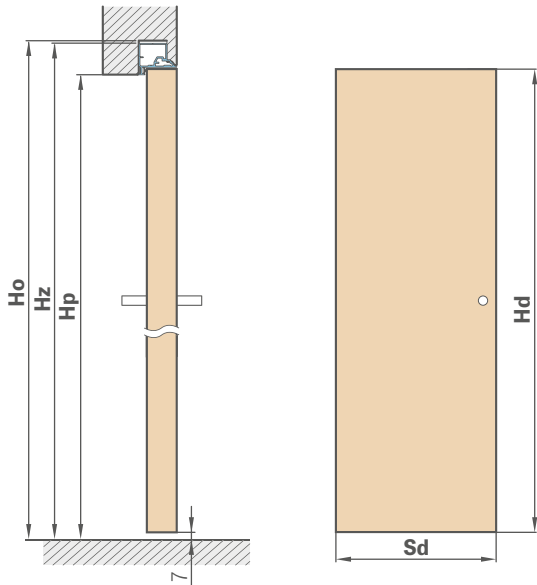

Door leaf width	Construction opening width	Frame outer width	Clear opening width
Sd [mm]	So [mm]	Sz [mm]	Sp [mm]
620	700	690	605
720	800	790	705
820	900	890	805
920	1000	990	905
1020	1100	1090	1005

Door leaf height	Construction opening height	Frame outer height	Clear opening height
Hd [mm]	Ho [mm]	Hz [mm]	Hp [mm]
2020 (2102 ¹⁾)	2069 (2152 ¹⁾)	2062 (2144 ¹⁾)	2020 (2102 ¹⁾)

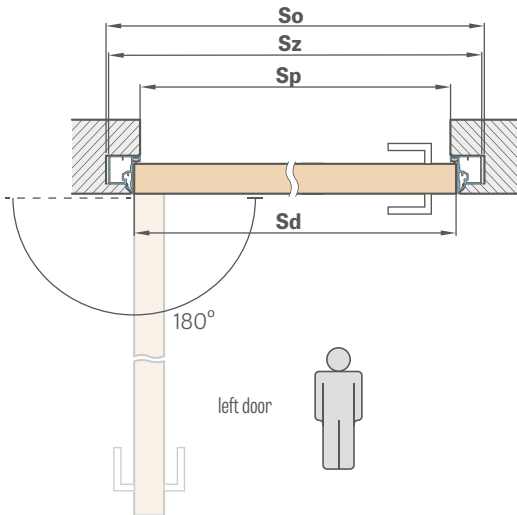

Gypsum board installation

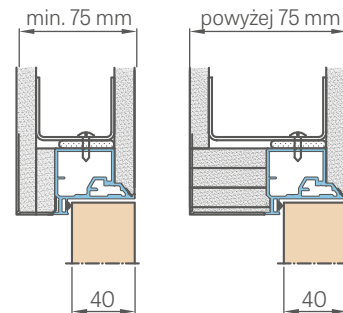

ALUMINIUM DOOR FRAME CROSS-SECTION

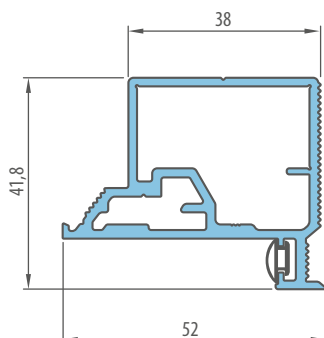

ENCLOSED IN WALL

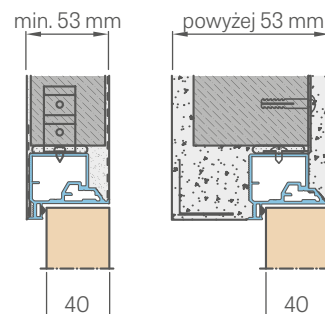

¹⁾ PLZ112 standard



SIDELIGHTS FOR DOORS

REBATED

GENERAL INFORMATION

The top and side lights are preassembled and glazed with the VSG 331 safety glass in a frosted or clear variant. (Please state your choice of glass when placing orders).

Additional components (e.g. wooden posts) may be required to integrate the side/top lights to the door, or more precisely to the adjustable or fixed frame, which the installer selects and supplies according to the existing opening conditions. ERKADO does not sell these items.

LIGHTING CATEGORIES

FOR **FIXED** DOOR FRAMES

FOR **ADJUSTABLE** DOOR FRAMES

FOR **SINGLE DOORS**

FOR **DOUBLE DOORS**

AVAILABLE PRODUCT PACKAGES

REBATED SINGLE DOORS with top, side and corner lights

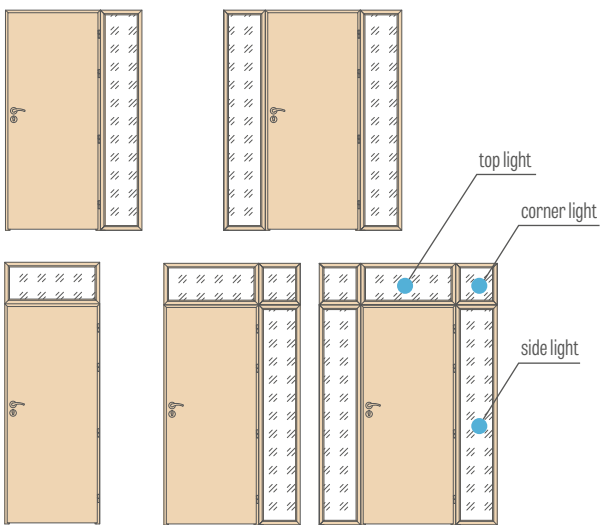

REBATED DOUBLE DOORS with top, side and corner lights

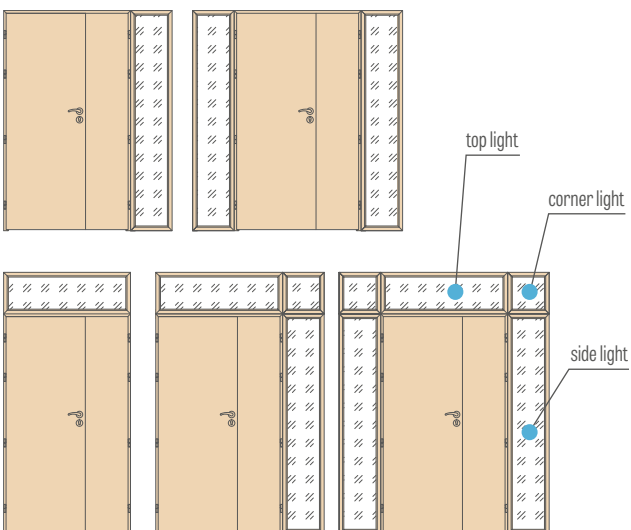

The matt VSG 331 or clear VSG 331 safety glass is included and the price is the same for all facings and ranges for rebated door frames.

To paint coated lights + 50% charge applies

Fitting strips for lights are fixed with headless pins which are seen as small dark spots once nailed (especially in white facings and paint coated lights).

Lighting not available in CPL 0.2 and CPL 0.7 laminates

Side lights for rebated adjustable door frame
Architrave 6cm /architrave 8cm

"30" "40" "50" "60"

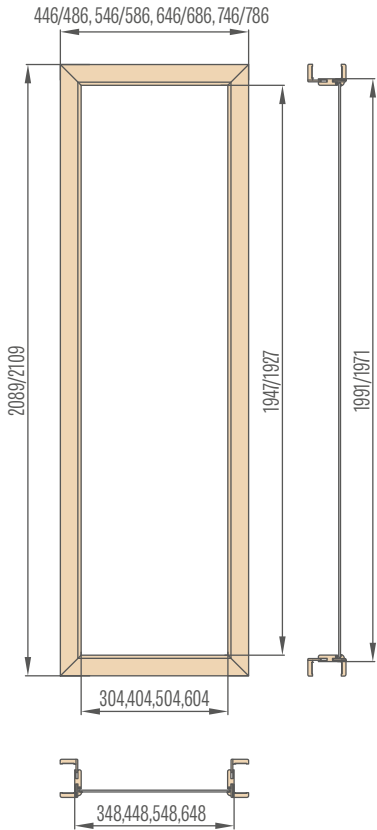

Corner lights for rebated adjustable door frame
architrave 6cm /architrave 8cm

"30" "40" "50" "60"

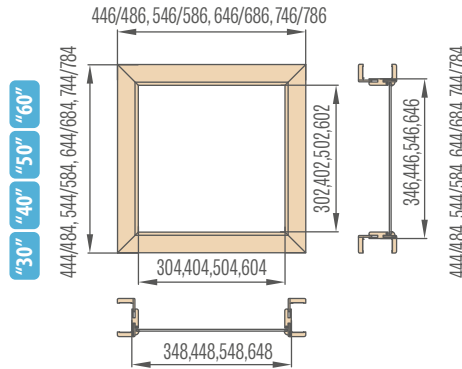

Top lights for rebated adjustable door frame in single doors,
architrave 6 cm/architrave 8 cm

"60" "70" "80" "90" "100"

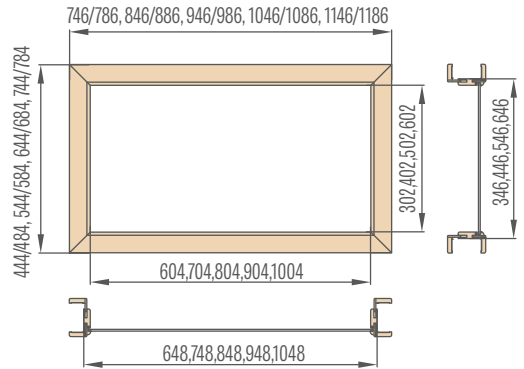

Top lights for adjustable door frame in rebated double doors architrave 6cm /architrave 8cm

"90" "100" "110" "120" "130" "140" "150" "160" "170" "180" "190"

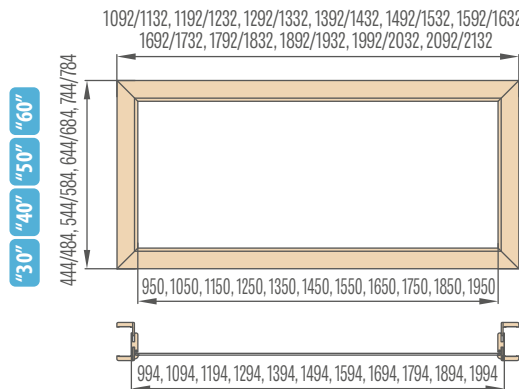

Calculation scheme for the wall opening height
for an adjustable frame:

- overall frame height
- + overall top light height
- 29 mm (for 60 mm angle bar) or 49 mm (for 80 mm angle bar)

Calculation scheme for the wall opening width
for an adjustable frame:

- overall frame width
- + overall top light width
- 58 mm (for 60 mm angle bar) or 98 mm (for 80 mm angle bar)

Side lights for fixed door frame

"30" "40" "50" "60"

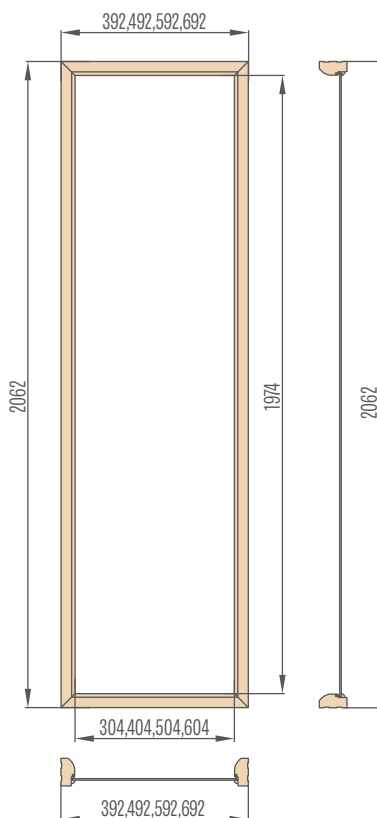

Corner lights for fixed door frame

"30" "40" "50" "60"

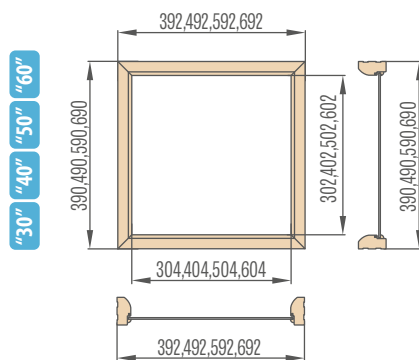

Top lights for fixed door frame in single doors

"60" "70" "80" "90" "100"

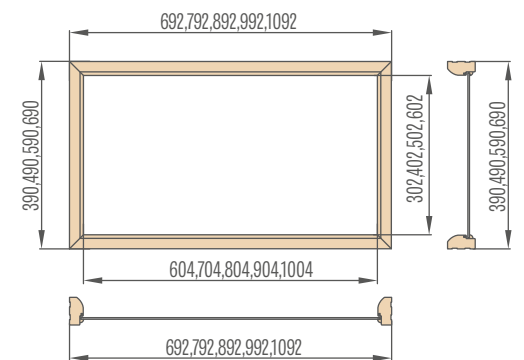

Top lights for fixed door frame in double doors

"90" "100" "110" "120" "130" "140" "150" "160" "170" "180" "190"

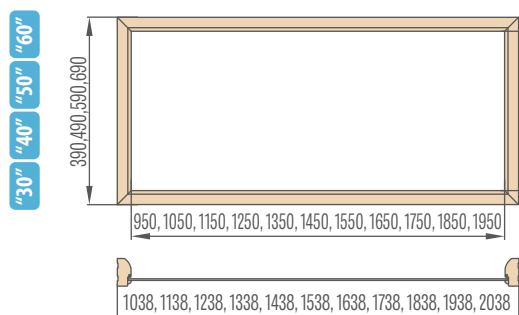

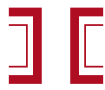

DOOR FRAMES

- The adjustable and fixed rebated door frames can be used for all types of ERKADO internal doors made in both flush and STILE panelled technologies.
- The adjustable non-rebated door frames can be used for internal doors made in both flush and STILE panelled technologies. These door frames are supplied with three concealed hinges.
- The door frame is made with high quality MDF board and covered with durable wood grain film or coated with durable UV paint.
- Depending on the technology, the door frames are faced with: GREKO, CPL, PREMIUM and UV paint.
- The frames for STILE panelled doors have a third hinge as standard.
- Each adjustable and fixed frame comes complete with disassembled frame components, hinges and screws. The components are supplied with pre-drilled holes for fixing.
- Each set is enclosed with assembly manual and warranty certificate.
- The fixed door frame for Herse collection is rectangular and its core is made of glulam.

ADJUSTABLE DOOR FRAME – REBATED DOORS



ADJUSTABLE OVERLAY FRAME FOR STEEL DOOR FRAME



ADJUSTABLE DOOR FRAME – NON-REBATED DOORS



STAND FIXED DOOR FRAME – REBATED DOORS



STANDARD SQUARE FOR AN ADJUSTABLE DOOR FRAME

architrave 6 cm / architrave 8 cm

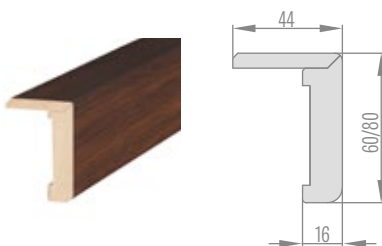

SQUARE WITH EXTENDED TONGUE FOR ADJUSTABLE DOOR FRAME

architrave 6 cm / architrave 8 cm

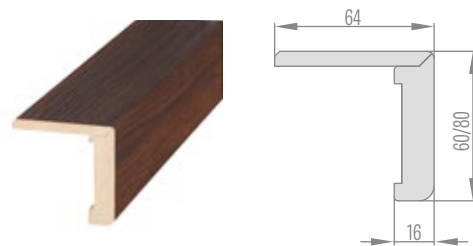

ADJUSTABLE REBATED DOOR FRAME

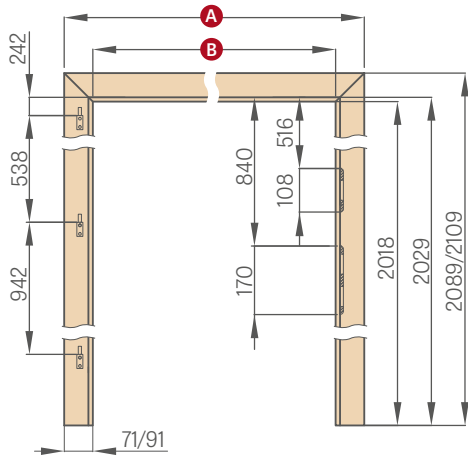

	"60"	"70"	"80"	"90"	"100"	"110"
A	746 / 786	846 / 886	946 / 986	1046 / 1086	1146 / 1186	1246 / 1286
B	604	704	804	904	1004	1104

architrave 6 cm / architrave 8 cm

ADJUSTABLE NON-REBATED FRAME – PL STANDARD

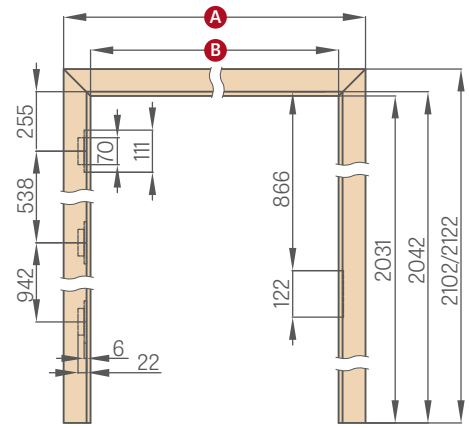

	"60"	"70"	"80N"	"80"	"90"	"100"	"110"
A	771 / 811	871 / 911	947 / 987	971 / 1011	1071 / 1111	1171 / 1211	1271 / 1311
B	629	729	805	829	929	1029	1129

ADJUSTABLE REBATED DOOR FRAME – PL2112 STANDARD

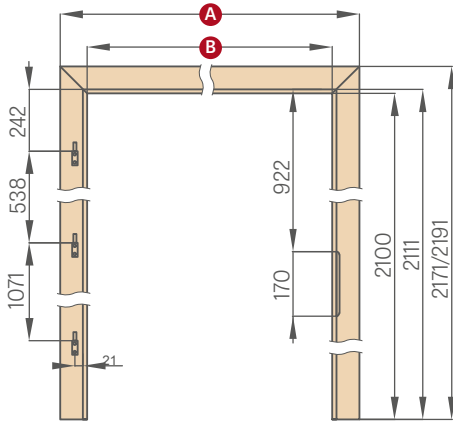

	"60"	"70"	"80"	"90"	"100"	"110"
A	746 / 786	846 / 886	946 / 986	1046 / 1086	1146 / 1186	1246 / 1286
B	604	704	804	904	1004	1104

ADJUSTABLE NON-REBATED DOOR FRAME – PL2112 STANDARD

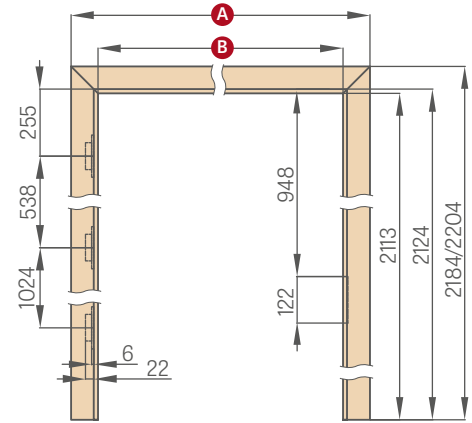

	"60"	"70"	"80N"	"80"	"90"	"100"	"110"
A	771 / 811	871 / 911	947 / 987	971 / 1011	1071 / 1111	1171 / 1211	1271 / 1311
B	629	729	805	829	929	1029	1129

ADJUSTABLE REBATED DOOR FRAME, TUNNEL TYPE

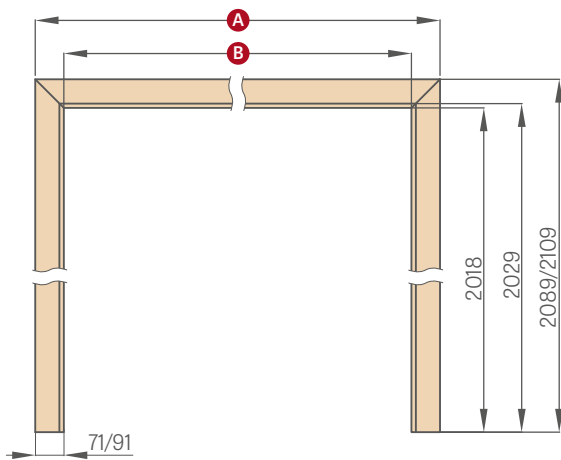

	"60"	"70"	"80"	"90"	"100"	"110"	"120"
A	746 / 786	846 / 886	946 / 986	1046 / 1086	1146 / 1186	1246 / 1286	1346 / 1386
B	604	704	804	904	1004	1104	1204
	"130"	"140"	"150"	"160"	"170"	"180"	"190"
A	1446 / 1486	1546 / 1586	1646 / 1686	1746 / 1786	1846 / 1886	1946 / 1986	2046 / 2086
B	1304	1404	1504	1604	1704	1804	1904

architrave 6 cm / architrave 8 cm

CASING DOOR FRAME

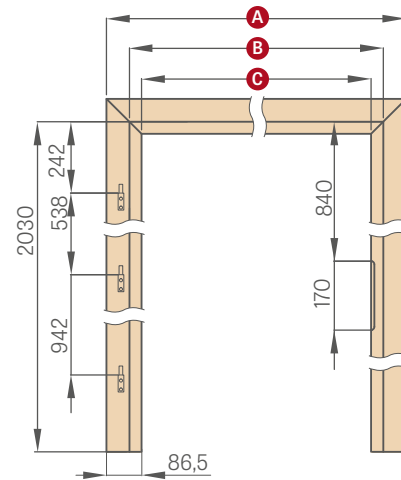

	"60"	"70"	"80"	"90"	"100"
A	737	837	937	1037	1137
B	624	724	824	924	1024
C	564	664	764	864	964

FIXED DOOR FRAME

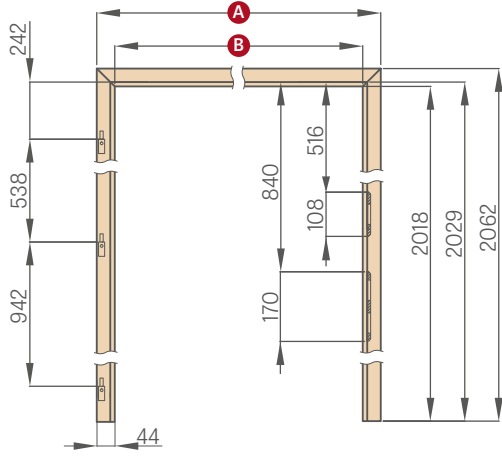

	"60"	"70"	"80"	"90"	"100"	"110"
A	692	792	892	992	1092	1192
B	604	704	804	904	1004	1104

REVERSE DOOR FRAME

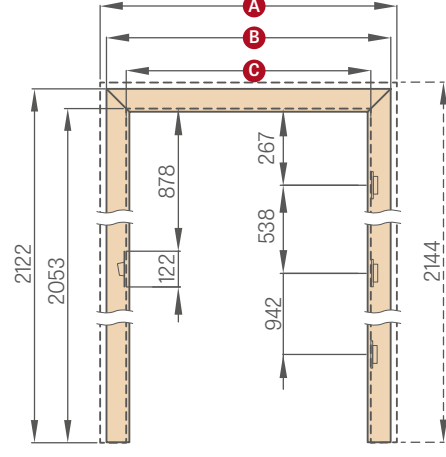

	"60"	"70"	"80N"	"80"	"90"	"100"	"110"
A	834	934	1010	1034	1134	1234	1334
B	791	891	967	991	1091	1191	1291
C	652	752	828	852	952	1052	1152

FIXED DOOR FRAME FOR DOUBLE DOORS

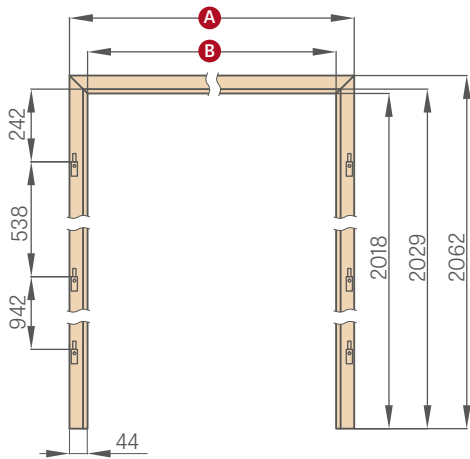

	"90"	"100"	"110"	"120"	"130"	"140"
A	1038	1138	1238	1338	1438	1538
B	950	1050	1150	1250	1350	1450

	"150"	"160"	"170"	"180"	"190"
A	1638	1738	1838	1938	2038
B	1550	1650	1750	1850	1950

ADJUSTABLE REBATED DOOR FRAME FOR DOUBLE DOORS

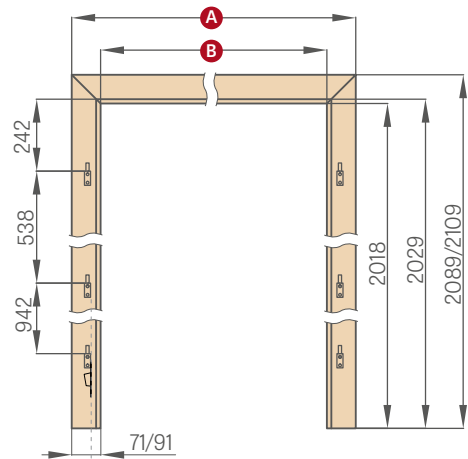

	"90"	"100"	"110"	"120"	"130"	"140"
A	1092/1132	1192/1232	1292/1332	1392/1432	1492/1532	1592/1632
B	950	1050	1150	1250	1350	1450

	"150"	"160"	"170"	"180"	"190"
A	1692/1732	1792/1832	1892/1932	1992/2032	2092/2132
B	1550	1650	1750	1850	1950

architrave 6 cm / architrave 8 cm

FIXED DOOR FRAME FOR GLASS DOORS

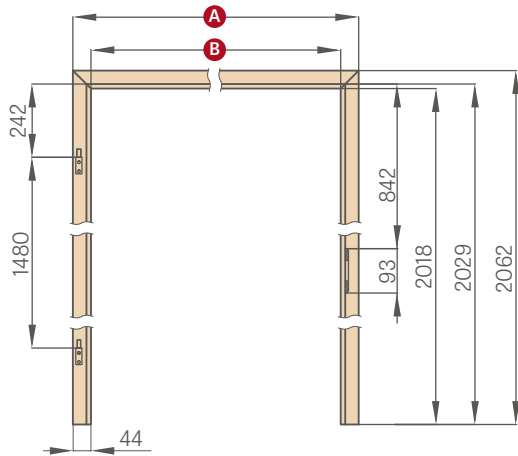

	"60"	"70"	"80"	"90"
A	692	792	892	992
B	604	704	804	904

10 mm pin hinge for glass panes frames

ADJUSTABLE REBATED DOOR FRAME FOR GLASS DOORS

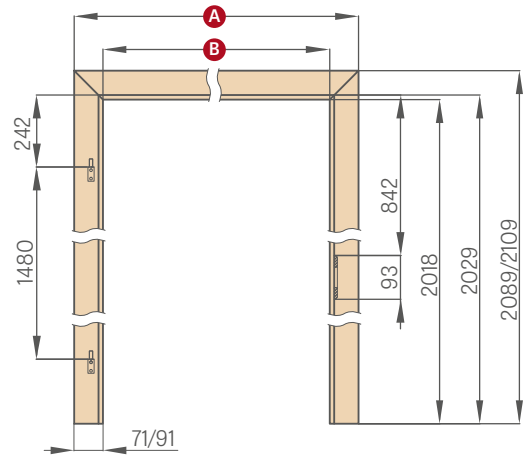

	"60"	"70"	"80"	"90"
A	746/786	846/886	946/986	1046/1086
B	604	704	804	904

architrave 6 cm / architrave 8 cm



TUNNEL TYPE ADJUSTABLE DOOR FRAME

REBATED / NON-REBATED

TUNNEL TYPE DOOR FRAMES

The tunnel type door frames are adjustable door frames without any hardware. They are made with a top strip and two vertical strips.

They can be used to finish door openings and safeguard wall corners, but mainly are fitted for interior decoration effects.

The tunnel type adjustable rebated door frames are also used in the ERKADO sliding systems.

The tunnel type adjustable non-rebated door frames are not used in the sliding systems.

Depending on the system, we use the following rebated tunnels:

TUNNEL FOR SP1N	Wall-mounted single sliding system
TUNNEL FOR SP2N	Wall-mounted double sliding system
TUNNEL FOR SP1C.100	Single "100" pocket sliding system
TUNNEL FOR SP2C.100	Double "100" pocket sliding system
TUNNEL FOR SP1C.125	Single "125" pocket sliding system
TUNNEL FOR SP2C.125	Double "125" pocket sliding system
Encasing ZN1	Wall encasing for one side of the single door systems SP1C.100 and SP1C.125
Encasing ZN2	Wall encasing for one side of the double door systems SP2C.100 i SP2C.125

ADJUSTABLE REBATED TUNNELS

	"60"	"70"	"80"	"90"	"100"	"110"	"120"	"130"	"140"	"150"	"160"	"170"	"180"	"190"
Opening width in the wall	688	788	888	988	1088	1188	1288	1388	1488	1588	1688	1788	1888	1988
Tunnel outer width	648	748	848	948	1048	1148	1248	1348	1448	1548	1648	1748	1848	1948
Tunnel opening width	604	704	804	904	1004	1104	1204	1304	1404	1504	1604	1704	1804	1904
Frame cover width for tunnel Architraves 6cm / Architraves 8cm	746 / 786	846 / 886	946 / 986	1046 / 1086	1146 / 1186	1246 / 1286	1346 / 1386	1446 / 1486	1546 / 1586	1646 / 1686	1746 / 1786	1846 / 1886	1946 / 1986	2046 / 2086
Opening height in the wall	2060 (2142) ¹⁾													
Tunnel outer height	2040 (2122) ¹⁾													
Tunnel opening height	2018 (2100) ¹⁾													
Tunnel cover height architrave 6 cm / architrave 8 cm	2089 / 2109 (2171 / 2191) ¹⁾													

ADJUSTABLE NON-REBATED TUNNELS

	"60"	"70"	"80N"	"80"	"90"	"100"	"110"	"120"	"130"	"140"	"150"	"160"	"170"	"180"
Opening width in the wall	713	813	888	913	1013	1113	1213	1313	1413	1513	1613	1713	1813	1913
Tunnel outer width	673	773	849	873	973	1073	1173	1273	1373	1473	1573	1673	1773	1873
Tunnel opening width	629	729	805	829	929	1029	1129	1229	1329	1429	1529	1629	1729	1829
Frame cover width for tunnel Architraves 6cm / Architraves 8cm	771 / 811	871 / 911	947 / 987	971 / 1011	1071 / 1111	1171 / 1211	1271 / 1311	1371 / 1411	1471 / 1511	1571 / 1611	1671 / 1711	1771 / 1811	1871 / 1911	1971 / 2011
Opening height in the wall	2073 (2155) ¹⁾													
Tunnel outer height	2053 (2135) ¹⁾													
Tunnel opening height	2031 (2113) ¹⁾													
Tunnel cover height architrave 6 cm / architrave 8 cm	2102 / 2122 (2184 / 2204) ¹⁾													

¹⁾ PL2112 standard



STEEL DOOR FRAME

FOR GRAF STILE PANELLED, FLUSH & GLASS DOORS

ADJUSTABLE STEEL DOOR FRAME (OVERLAPPING),

sheet metal th. 1.5 mm

Welded and painted in RAL STANDARD and RAL ERKADO

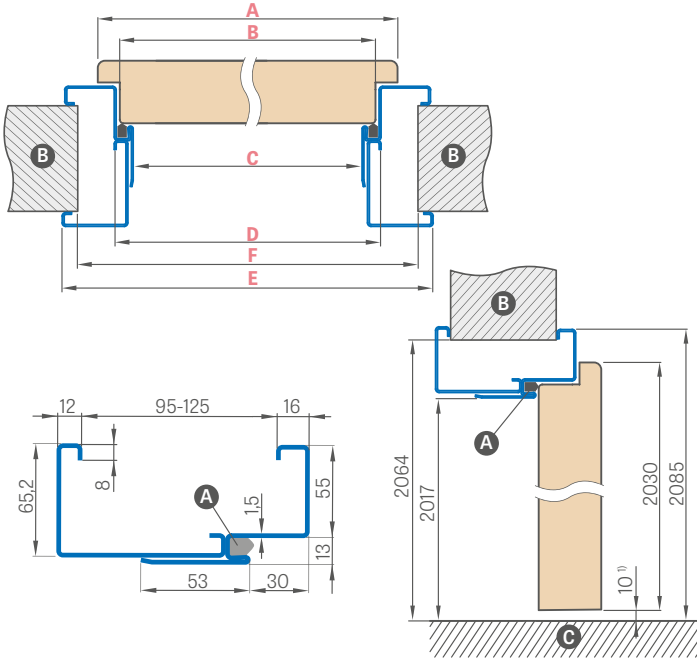

SQUARE STEEL DOOR FRAME (LARGE),

sheet metal th. 1.2 mm

Welded and painted in RAL STANDARD and RAL ERKADO

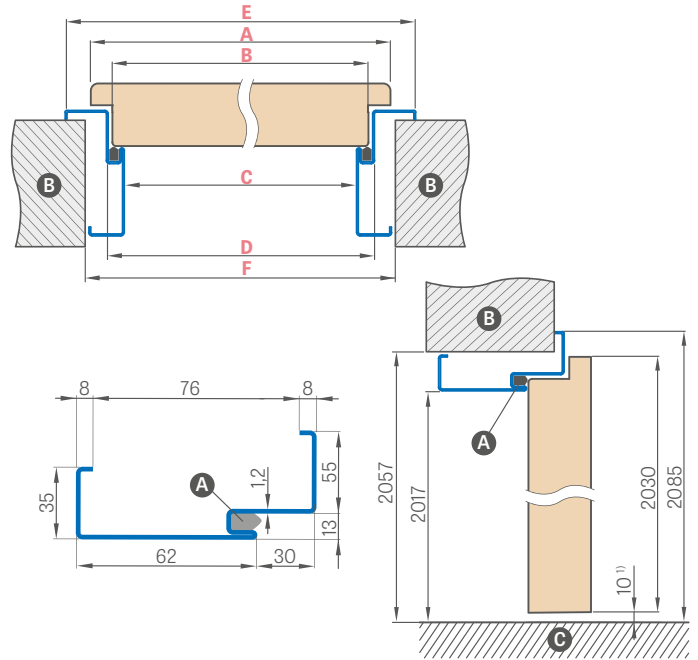

¹⁾ allowable deviation due to frame dimensional tolerance of +-3mm (we recommend to check before installation)

Door width	A	B	C	D	E	F
"60"	644	617	601	627	737	695
"70"	744	717	701	727	837	795
"80"	844	817	801	827	937	895
"90"	944	917	901	927	1037	995
"100"	1044	1017	1001	1027	1137	1095
"110"	1144	1117	1101	1127	1237	1195

Door width	A	B	C	D	E	F
"60"	644	617	601	627	737	681
"70"	744	717	701	727	837	781
"80"	844	817	801	827	937	881
"90"	944	917	901	927	1037	981
"100"	1044	1017	1001	1027	1137	1081
"110"	1144	1117	1101	1127	1237	1181

Adjustment Range min-max (mm)

95-125
125-155
155-185
185-215
215-245
245-275
275-305

RAL STANDARD



RAL ERKADO



NEW

FITTING THE SQUARE FRAME

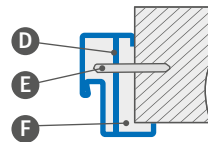

- A**-gasket
- B**-Wall
- C**-floor
- D**-mounting anchor
- E**-anchor bolt
- F**-To be filled

EXTRA CHARGES

electric door strike

door closer reinforcement

galvanised sheet steel

adjustable frame "100" or "110"

fixed frame "100" or "110"

door frame for double doors

standard 2112

non-typical RAL (intensive, pearly and metallic colours not included)

STEEL DOOR FRAME

NON-REBATED

FOR PANELLED AND FLUSH DOORS

ADJUSTABLE STEEL NON-REBATED DOOR FRAME (OVERLAPPING), sheet metal th. 1.5 mm

Welded and painted in RAL STANDARD and RAL ERKADO

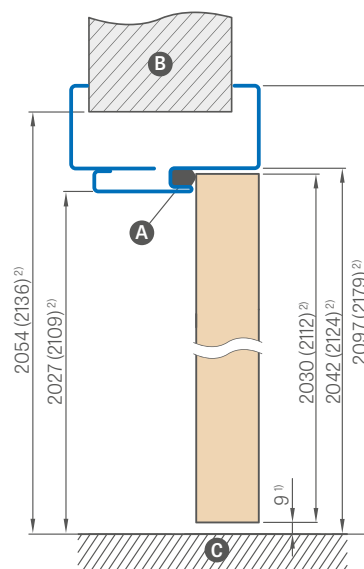
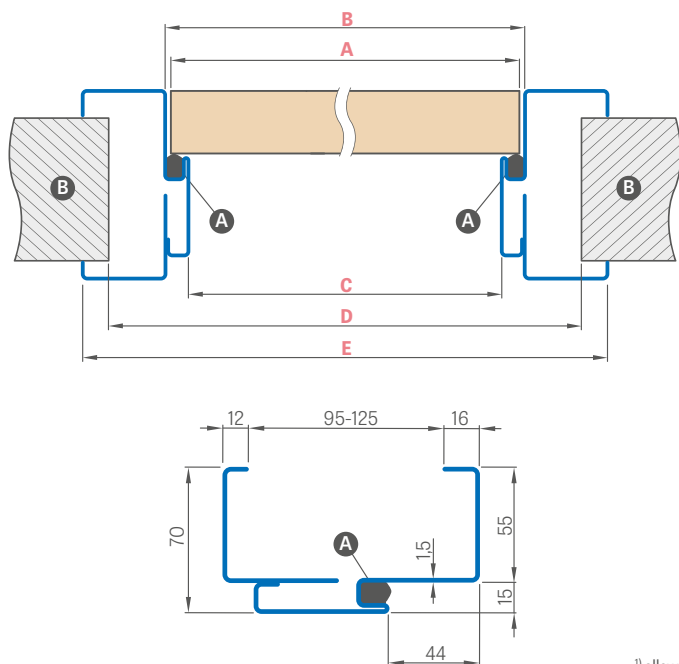

¹⁾ allowable deviation due to frame dimensional tolerance of +- 3 mm (we recommend to check before installation)

²⁾ 2112 Standard

Door width	A	B	C	D	E
"60"	644	650	620	695	760
"70"	744	750	720	795	860
"80"	844	850	820	895	960
"90"	944	950	920	995	1060
"100"	1044	1050	1020	1095	1160
"110"	1144	1150	1120	1195	1260

A - gasket **B** - wall **C** - floor

Adjustment Range min-max (mm)
95-125
125-155
155-185
185-215
215-245
245-275
275-305

Door frames come with three hinges as standard.

EXTRA CHARGES

door closer reinforcement

galvanised sheet steel

adjustable frame "100" or "110"

standard 2112

non-typical RAL (intensive, pearly and metallic colours not included)

RAL STANDARD

RAL 9003	RAL 9010	RAL 9016	RAL 8003	RAL 8017	RAL 7016	RAL 7022	RAL 9005	RAL 7047	RAL 1001

RAL ERKADO

CAPPUCCINO	LIGHT GREY	DARK GREEN	ROYAL BLUE	ASHY	ANTHRACITE	BLACK

NEW



ADJUSTABLE OVERLAY DOOR FRAME

FOR STEEL DOOR FRAMES

HANDLE POSITION IN AN OVERLAY DOOR FRAME

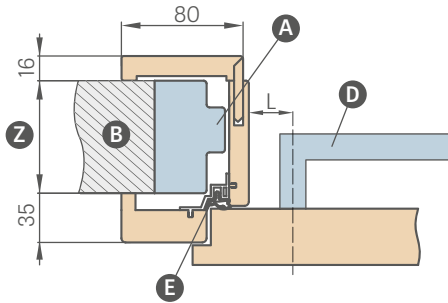

L – distance between the handle centre line and the frame strip edge
 L = 28 mm for panelled and flush doors (available with all interior door handles presented in the range)

NOTE: Check the handle backplate/escutcheon dimensions before installation.
 Adjustable overlay door frame of over 200 mm consists of two components, and a frame of over 320 mm consists of three components.

AVAILABLE WIDTHS FOR OVERLAY FRAMES:

60 70 80 90 100

	Adjustment range min-max (mm)
1 component	80-100
	100-120
	120-140
	140-160
	160-180
2 Components	180-200
	200-220
	220-240
	240-260
	260-280
3 Components	280-300
	300-320
	320-340
	340-360
	360-380
	380-400
	400-420
	420-440

- 120 mm extension for the casing door frame – surcharge
- standard square for the casing door frame – surcharge
- square with an extended tongue – surcharge

OVERLAY DOOR FRAME DIAGRAM

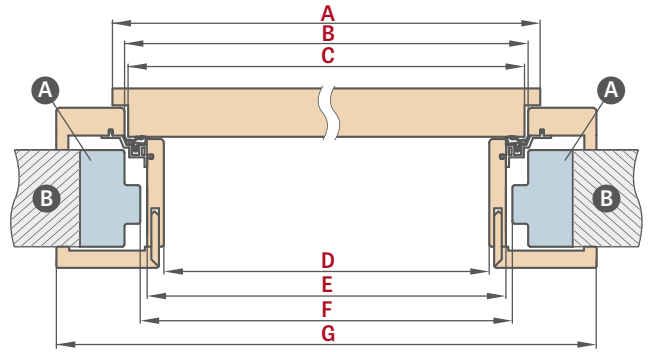

Door width	A	B	C	D	E	F	G
"60"	644	624	618	564	592	598	733
"70"	744	724	718	664	692	698	833
"80"	844	824	818	764	792	798	933
"90"	944	924	918	864	892	898	1033
"100"	1044	1024	1018	964	992	998	1133

F – min dimension of the steel frame opening, on which to fit an overlay door frame. This dimension can exceed the recommended one by max 20 mm. For greater frame opening, ensure the architraves cover the wall appropriately.

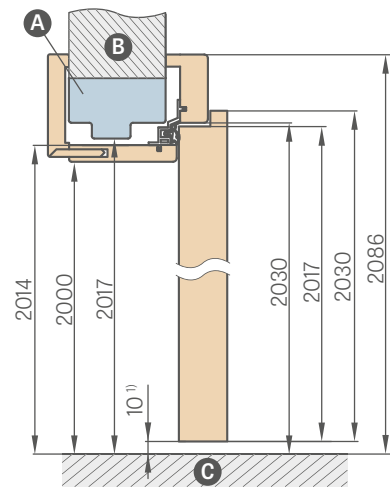

¹⁾ allowable deviation due to frame dimensional tolerance of ± 3 mm
 (we recommend to check before installation)

- A** – steel door frame
- B** – wall
- C** – floor
- D** – handle
- E** – aluminium profile with gasket
- Z** – range from 80 mm to 255 mm

- tunnel type door frame for widths of 60, 70, 80, 90, 100 are at the price of the adjustable overlay door frame.
- the tunnel is of the same dimensions as the overlay door frame and is not pre-drilled for hinge or door strike plate, but is supplied with a gasket.
- prices of door frames for double doors $\pm 30\%$

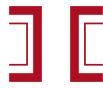

REVERSE DOOR FRAME

REVERSE DOOR LEAVES

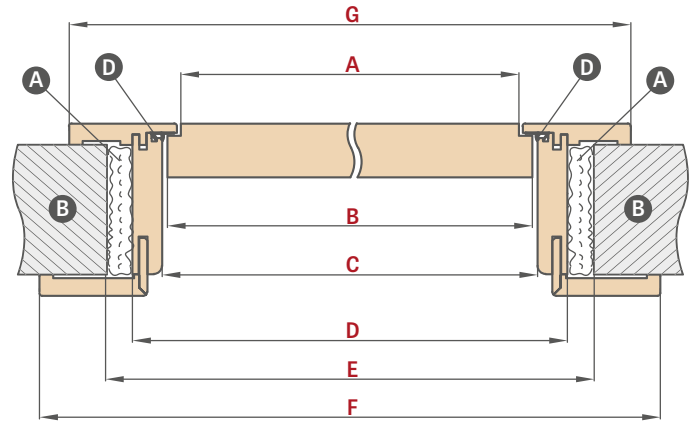
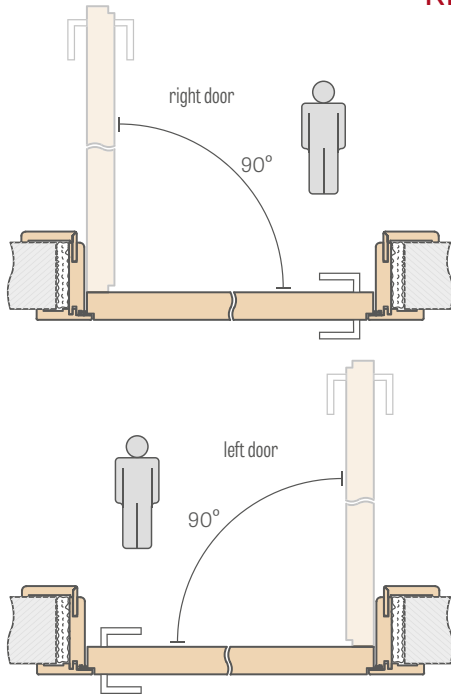

ADJUSTMENT RANGE FOR REVERSE DOOR FRAME

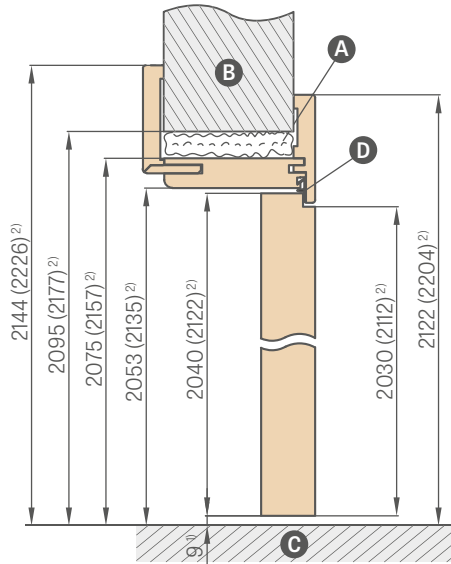
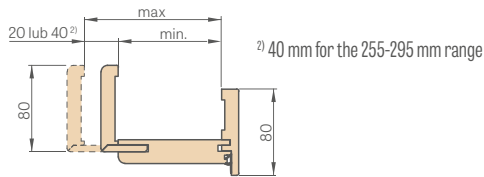

¹⁾ allowable deviation due to frame dimensional tolerance of +- 3 mm
(we recommend to check before installation)

²⁾ PL2112 Standard

Door width	A	B	C	D	E	F	G
"60"	624	644	652	696	736	834	791
"70"	724	744	752	796	836	934	891
"80N"	800	820	828	872	900	1010	966
"80"	824	844	852	896	936	1034	991
"90"	924	944	952	996	1036	1134	1091
"100"	1024	1044	1052	1096	1136	1234	1191
"110"	1124	1144	1152	1196	1236	1334	1291

A foam **B** wall **C** floor **D** rubber gasket

1 component
2 Components

Adjustment Range min-max (mm)
75-95
95-115
115-135
135-155
155-175
175-195
195-215
215-235
235-255
255-295
295-315
315-335
335-355

NOTE: The working range of frame will be reduced by 3 mm (for single-sided use) or 6 mm (for double-sided use) when a set (crosshead + pilasters) for the reverse adjustable frame is selected. Example: assume a 140 mm thick wall with a single-sided kit to be 143mm thick, while with a double-sided kit to be 146 mm thick, and look for a corresponding masonry coverage in the table for rebated frames (p. 179), non-rebated frames (p. 176) or reverse frames (p. 175).

- the frame for reverse doors is available as a standard with 8 cm square joined at 45 degrees or 90 degrees at an extra charge (not available for 75-95 mm)
- the frame contains two so-called concealed hinges invisible when the leaf is closed
- available decors within the colour group: GREKO, PREMIUM, ST CPL and WHITE TITANIUM UV varnish
- option to use black or golden hinges and strike plate – surcharge

- 120 mm extension for reverse faced or painted frame – surcharge
- adjustable square with 2 cm extended tongue and standard square for adjustable frames in all decors – surcharge
- the door frame above 295 mm is composed of two parts
- top panels can be glued to the wall for an additional charge page 148
- PL2112 Standard for a surcharge of 15%



ADJUSTABLE DOOR FRAME

NON-REBATED DOOR LEAVES

ADJUSTABLE DOOR FRAME RANGE

80-95 mm

architrave 6 cm / architrave 8 cm

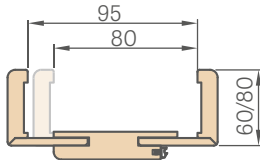

The square tongue is to be trimmed by a customer to required size, for door frames within 80-95 mm range

DOOR FRAME JOINTS

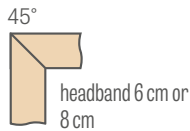
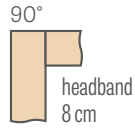

ADJUSTABLE DOOR FRAME RANGE

architrave 6 cm / architrave 8 cm

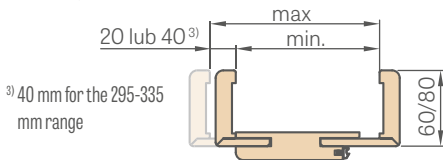

Adjustment Range min-max (mm)	
1 component	80-95
	95-115
	115-135
	135-155
	155-175
	175-195
	195-215
	215-235
	235-255
	255-275
2 Components	275-295
	295-335
	335-355
	355-375
	375-395
	395-415

ADJUSTABLE DOOR FRAME DIAGRAM

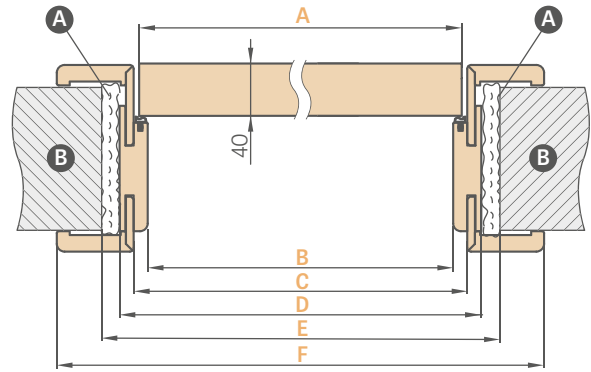

Door width	A	B	C	D	E	F
"60"	644	629	651	673	714	771*/811**
"70"	744	729	751	773	814	871*/911**
"80N"	820	805	827	849	888	947*/987**
"80"	844	829	851	873	914	971*/1011**
"90"	944	929	951	973	1014	1071*/1111**
"100"	1044	1029	1051	1073	1114	1171*/1211**
"110"	1144	1129	1151	1173	1214	1271*/1311**

* architrave 6 cm / ** architrave 8 cm

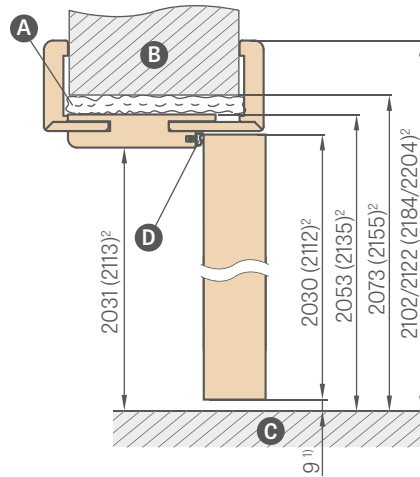

¹⁾ allowable deviation due to frame dimensional tolerance of ± 3 mm (we recommend to check before installation)

²⁾ PL2112 Standard for a surcharge of 15%

A foam **B** wall **C** floor **D** rubber gasket

NOTE: The working range of frame will be reduced by 3 mm (for single-sided use) or 6 mm (for double-sided use) when a set (crosshead + pilasters) for the non-rebated adjustable frame is selected. Example: assume a 140 mm thick wall with a single-sided kit to be 143 mm thick, while with a double-sided kit to be 146 mm thick, and look for a corresponding masonry coverage in the table for rebated frames (p. 179), non-rebated frames (p. 176) or reverse frames (p. 175).

- PL2112 standard frame +15% on the frame price before surcharges
- adjustable rebate-free door frame in CPL0.2 is also used in combination with doors in CPL0.7
- option to use black or golden hinges and strike plate – surcharge
- joints at 90 degrees possible for door frames with the 8 cm architraves only. Extra charge for frame joints at 90°
- the door frame above 335 mm is composed of two parts
- prices of adjustable door frames for double doors + 30%
- extension of 120 mm for non-rebated faced frame and CPL 0.2 and painted frame – surcharge

- adjustable square with 2 cm extended tongue and standard square for adjustable frames available in all facings and in CPL0.2 and lacquer – surcharge – for 6 cm and 8 cm architraves
- tunnel type door frame for widths of 60, 70, 80N, 80, 90, 100 are at the price of the adjustable rebated door frame (see table p. 179)
- tunnel type door frame for widths of 110, 120, 130, 140, 150, 160, 170, 180, 190 are at the price of the adjustable door frame for rebated double doors (see table p. 179)
- top panels glued to the wall (only for frames with 8 cm corner) – p. 148
- electric door strike (only available for lever tumbler lock) – surcharge

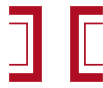

FIXED DOOR FRAME

REBATED DOOR LEAVES

FIXED DOOR FRAME

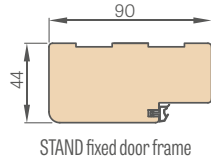

CLIP-ON SQUARE 6 cm and 8 cm (3 pcs. of clips supplied)

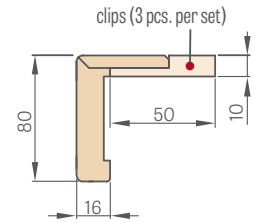

ARCHITRAVES 8 mm

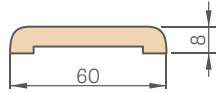

ARCHITRAVES 16 mm

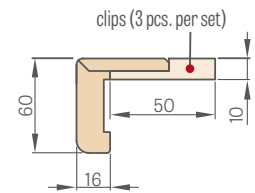
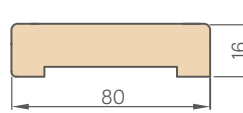

Price for a set of 2 pcs. x 213.5 cm and 1 pc. x 112 cm (for door leaves from "60" to "90")
 Price for a set of 3 pcs. x 213.5 cm (for door leaves from "100" to "190")

Price for a set of 2 pcs. x 214.5 cm and 1 pc. x 112 cm (for door leaves from "60" to "80")
 Price for a set of 3 pcs. x 214.5 cm (for door leaves from "90" to "180")

QUARTER ROUND

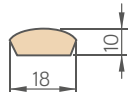

Price for a set of 2 pcs. x 211.5 cm and 1 pc. x 106.5 cm (for door leaves from "60" to "90")
 Price for a set of 3 pcs. x 211.5 cm (for door leaves from "100" to "190")

STAND FIXED FRAME

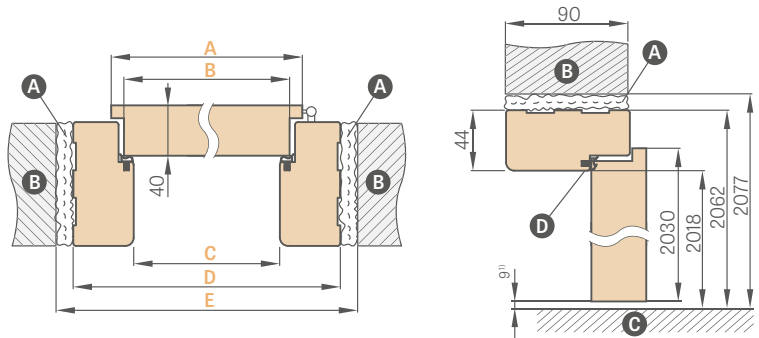

¹⁾ allowable deviation due to frame dimensional tolerance of ± 3 mm
 (we recommend to check before installation)

ELECTRIC DOOR STRIKE

SKIRTING BOARD length 2.40 lin.m.

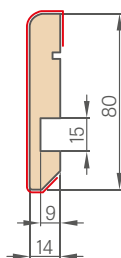

- the skirting board is made of moisture resistant MDF board. Available variants: WHITE TITANIUM UV paint; facings: GREKO, ST CPL, PREMIUM and in a base facing to be paint coated.
- fitting method: bonding to wall

- fixed door frame for double doors + 30%
- non-rebated fixed door frame - NA
- the fixed frame, architrave and clip-on square in CPL 0.2 are also used in the set for door leaves in CPL 0.7
- black strike plate only available for GRAF glass door frames - surcharge

Door width	A	B	C	D	E
"60"	644	618	604	692	722
"70"	744	718	704	792	822
"80"	844	818	804	892	922
"90"	944	918	904	992	1022
"100"	1044	1018	1004	1092	1122
"110"	1144	1118	1104	1192	1222

A foam **B** wall **C** floor **D** rubber gasket

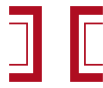

ADJUSTABLE DOOR FRAME

REBATED DOOR LEAVES



ADJUSTABLE DOOR FRAME
above 320 mm

Adjustable door frame with a range above 320 mm consists of two components.

ADJUSTABLE DOOR FRAME RANGE

architrave 6 cm / architrave 8 cm

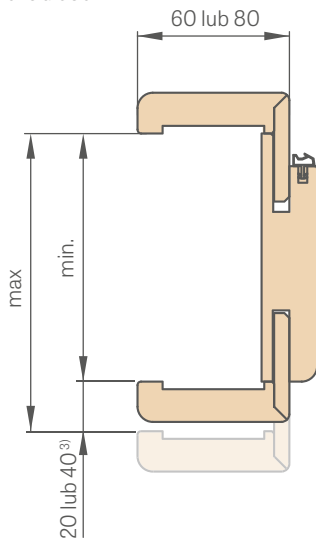

³⁾ 40 mm for the 280-320 mm range

DOOR FRAME JOINTS

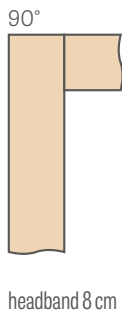

headband 8 cm

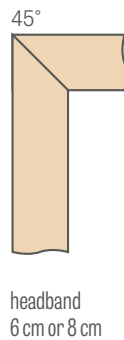

headband
6 cm or 8 cm

ADJUSTABLE DOOR FRAME DIAGRAM

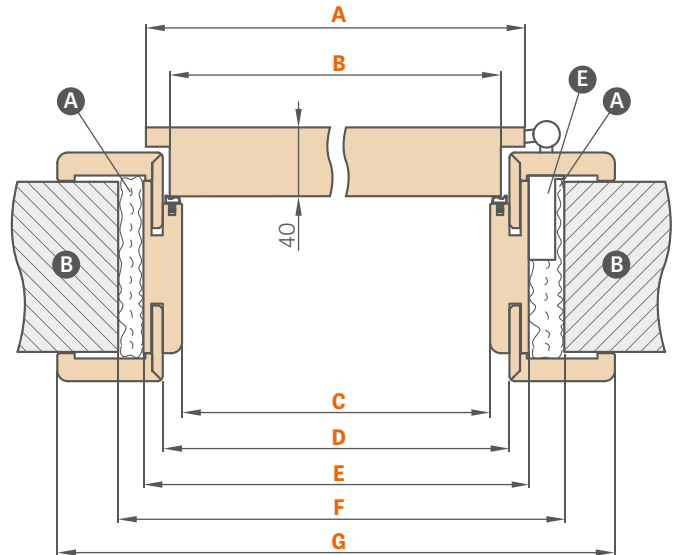

Door width	A	B	C	D	E	F	G
"60"	644	618	604	626	648	688	746*/786**
"70"	744	718	704	726	748	788	846*/886**
"80"	844	818	804	826	848	888	946*/986**
"90"	944	918	904	926	948	988	1046*/1086**
"100"	1044	1018	1004	1026	1048	1088	1146*/1186**
"110"	1144	1118	1104	1126	1148	1188	1246*/1286**

* architrave 6 cm / ** architrave 8 cm

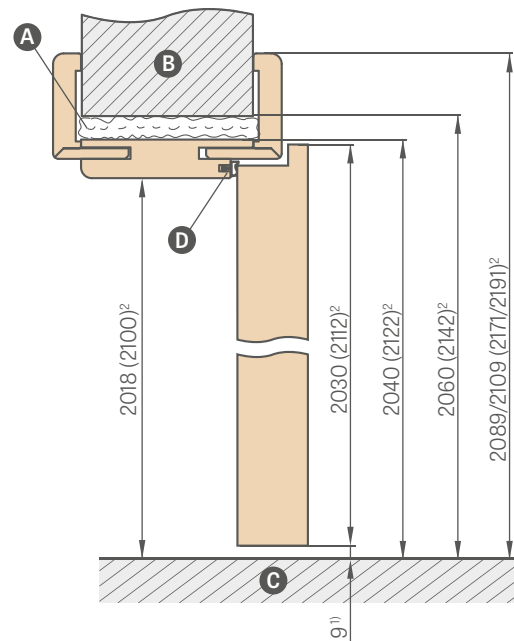

Installation video:
<https://youtu.be/habWxYCI98c>

¹⁾ allowable deviation due to frame dimensional tolerance of ± 3 mm (we recommend to check before installation)

²⁾ PL2112 Standard for a surcharge of 15%

- A** foam
- B** wall
- C** floor
- D** rubber gasket
- E** hinge socket

	Adjustment Range min-max (mm)
1 component	80-100
	100-120
	120-140
	140-160
	160-180
	180-200
	200-220
	220-240
	240-260
	260-280
2 Components	280-320
	320-340
	340-360
	360-380
	380-400
	400-420

NOTE: The working range of frame will be reduced by 3 mm (for single-sided use) or 6 mm (for double-sided use) when a set (crosshead + pilasters) for the rebated adjustable frame is selected. Example: assume a 140 mm thick wall with a single-sided kit to be 143mm thick, while with a double-sided kit to be 146 mm thick, and look for a corresponding masonry coverage in the table for rebated frames (p. 179), non-rebated frames (p. 176) or reverse frames (p. 175).

- PL2112 standard frame +15% on the frame price before surcharges
- the CPL 0.2 adjustable rebated frame is also used with CPL 0.7 door leaves
- joints at 90 degrees possible for door frames with the 8 cm architraves only. Additional charge for joining at 90 degrees – surcharge
- electric door strike – surcharge
- reinforcement for door closer – surcharge
- prices of fixed and adjustable door frames for double doors + 30%
- adjustable square with 2 cm extended tongue and standard square for adjustable frames available in all facings and in CPL 0.2 and lacquer – surcharge – for 6cm and 8 cm architraves
- black strike plate only available for GRAF glass door frames – surcharge
- extension of 120 mm for adjustable faced frame and CPL 0.2 and painted frame – surcharge
- possibility to make door frames ranging between 0 and 520 mm – an additional charge for each 2 cm is PLN 80, relative to the frame price of PLN 400-420 mm
- tunnel type door frame for both rebated and non-rebated door widths of 60, 70, 80N (only non-rebated), 80, 90, 100 are at the price of the rebated adjustable door frames.
- tunnel type door frame for both rebated and non-rebated door widths of 110, 120, 130, 140, 150, 160, 170, 180, 190 are at the price of the adjustable door frame for rebated double doors
- top panels glued to the wall (only for frames with 8 cm corner) - p. 148

The warranty certificate and assembly manual are attached with products. This Product Guide is for reference only, and shows current prices and product availability. The manufacturer reserves the right to modify prices and product availability without prior notice. Actual colours in colour charts can differ from these indicated in this Product Guide. Please consult the colours with original colour charts available at our dealer centres. The photos in the Product Guide are for reference only and dimensional proportions of some components can occur for different door leaf widths. We reserve the right to printing mistakes. The Product Guide is not an offer in legal terms and is published only for reference.

Edition I/2023/A applies from 14 February 2022.

The door should be selected on the basis of a basic design of a facility, prepared considering all applicable standards and provisions of law, as well as frequency and conditions of use. ERKADO offers several variants, but leaves the final choice to the Buyer, because only the Buyer or their representatives knows the purpose and conditions of use for the product to be ordered.

Certificates can be downloaded from our website www.erkado.pl

ERKADO

doors are our world

STEEL DOORS



ERKADO Sp. z o.o.

Gościeradów-Folwark
Osiedle POM 8
23-275 Gościeradów
POLAND
NIP 715-194-27-90

E-mail: biuro@erkado.pl
www.erkado.pl

CHECK PRICES

STEEL DOORS



INTERNAL DOORS



FEEL SAFE BEHIND OUR DOORS

FUNCTIONALITY • COST EFFICIENCY • AESTHETICS



SAFETY
Security class RC2



Ud $\leq 0,6 \text{ W}/(\text{m}^2\text{K})$

THERMAL EFFICIENCY
compliant with the requirements of
the "Clean Air" Programme



DURABILITY
high resistance to weather
conditions